



# CAMON®

OUTDOOR POWER EQUIPMENT

## MÁQUINAS & ACCESORIOS 2025





**GAIMA, S.A.**

Estrada de A Coruña, 355 - Ramil  
 (Lugo) - España  
 Teléfono: 982 264 219  
 gaima@gaima.net • www.gaima.net

**NºS DE TELÉFONO DIRECTO**

**☎ Recambios**

WhatsApp Recambios .....678 930 299  
 Manuel Trigo  
 (pedidos@gaima.net).....678 930 299  
 Iván Trigo  
 (ivantrigo@gaima.net) .....638 008 544  
 Manuel Ferreiro  
 (manuelferreiro@gaima.net) .....629 202 074

**☎ Servicio Técnico**

Juan Carlos Martínez.....678 930 741  
 José Cela.....serviciotecnico@gaima.net

**☎ Administración**

Laura Lombardía  
 lauralombardia@gaima.net.....678 930 181



**Orange** Carlos de la Uz  
 ☎ 686 950 575  
 carlosdelauz@gaima.net

**Light Orange** Salvador Rosell  
 ☎ 686 950 576  
 salvador.rosell@gaima.net

**Light Green** Antonio Fernández Plumas  
 ☎ 686 950 572  
 antonioplumas@gaima.net

**Light Blue** Ignacio Castillo  
 ☎ 686 950 574  
 ignacio.castillo@gaima.net

**Purple** Roberto Vicente Miguéns  
 ☎ 682 009 127  
 robertovicente@gaima.net

**Yellow** Joaquim Alves  
 ☎ 963 033 253  
 joaquimalves@gaima.net

**Light Orange** Ricardo Martins  
 ☎ 919 334 298  
 ricardomartins@gaima.net

**Red** Mauricio Salatino Gutiérrez  
 ☎ 680 566 627  
 mauriciosalatino@gaima.net



# ÍNDICE

• Accesorios carburadores adaptables.....	109, 110
• Accesorios jardín .....	188
• Accesorios motoazadas Camon-Pubert.....	51-57
• Accesorios robot .....	75
• Accesorios tractores cortacésped Simplicity .....	24-26
• Accesorios tractores cortacésped Camon .....	45, 46
• Accesorios tractores cortacésped adaptables .....	187
• Aceites y lubricantes.....	184
• Adaptadores cabezales nylon .....	19, 151-157, 176-177
• Afiladora de cadenas motosierra .....	91, 92
➤ <b>AHOYADORES CAMON Y ACCESORIOS</b> .....	76
➤ <b>AHOYADORES MARUYAMA Y ACCESORIOS</b> .....	13
• Arnés desbrozadores Maruyama .....	130
• Arnés desbrozadores Camon .....	130
• Asas y amortiguadores adaptables .....	124, 125
➤ <b>ASTILLADORAS ELÉCTRICAS</b> .....	81
➤ <b>ASTILLADORAS MOTOR GASOLINA</b> .....	81
➤ <b>ATADOR DE BATERÍA</b> .....	73
• Barras motosierras adaptables .....	84 - 88
• Barras motosierras Camon - Oregon.....	30, 84
• Barras motosierras Maruyama .....	14
• Baterías tractores cortacésped .....	185
• Bidones para transporte de combustible .....	129
➤ <b>BIOTRITURADORES GASOLINA CAMON</b> .....	78
• Bobinas electrónicas adaptables motores 4 tiempos ..	100, 101
• Bobinas electrónicas adaptables motores 2 tiempos ..	33, 99, 100
• Bombas de gasolina adaptables y pasatubos.....	172
• Bombas de aceite y accesorios adaptables.....	35, 119, 120
• Bujías.....	174
• Caballete troncos .....	185
• Cabezales nylon desbrozadores Maruyama+adaptadores.....	19
• Cabezales nylon desbrozadores Camon.....	152-157
• Cabezales nylon adaptables.....	152-157
• Cables bujías .....	101
• Cables cortacésped Camon y terminales .....	42, 145, 146
• Cables cortacésped Murray .....	145
• Cables cortacésped Simplicity.....	145
• Cables cortacésped Snapper .....	145
• Cables cortacésped adaptables .....	145
• Cables desbrozadoras ruedas Pubert-Camon.....	60
• Cables motoazadas Pubert-Camon .....	57
• Chapas engrase cadena .....	31, 98
• Chavetas adaptables .....	139
• Cadenas cortadas motosierras .....	30, 89
• Cámaras tractores adaptables.....	150
• Campanas de embrague adaptables .....	32, 115, 116
• Campanas protectoras adaptables desbrozadores .....	182
• Capuchones bujía adaptables.....	175
• Carburadores adaptables.....	20, 33, 109, 110
• Cargadores de batería .....	72
➤ <b>CARRETIILLAS MOTORIZADAS Y ACCESORIOS</b> .....	77
➤ <b>CARRETIILLAS DE PULVERIZAR Y ACCESORIOS</b> .....	77
• Cebadores carburadores adaptables .....	167, 168
• Cilindros y pistones adaptables.....	36-38, 92-94
• Codos de engranajes adaptables.....	182, 183
• Comprobador de corriente bujías.....	134
• Condensadores .....	144
➤ <b>CORTACÉSPEDES GASOLINA CAMON</b> .....	39, 40, 41
➤ <b>CORTACÉSPEDES ELÉCTRICOS CAMON</b> .....	39
➤ <b>CORTASETOS GASOLINA MARUYAMA</b> .....	9
➤ <b>CORTASETOS GASOLINA CAMON</b> .....	38
➤ <b>CORTASETOS ELÉCTRICOS CAMON</b> .....	38
• Correas cortacésped adaptables.....	141-143
• Correas cortacésped Simplicity.....	24, 142, 143
• Correas cortacésped Camon .....	141
• Correas motoazadas Pubert-Camon.....	57
• Correas desbrozadoras de ruedas.....	59
• Correas tractores cortacésped Simplicity .....	24, 142, 143
• Correas tractores cortacésped Camon.....	46
• Correas tractores cortacésped adaptables.....	140, 141
• Cubiertas tractores adaptables .....	149, 150
• Cuchillas cortasetos adaptables .....	167
• Cuchillas cortasetos Maruyama .....	18
• Cuchillas cortasetos Camon .....	167
• Cuchillas cortacésped Simplicity .....	24, 25, 137, 138
• Cuchillas cortacésped Camon.....	41, 135, 146
• Cuchillas cortacésped Flymo.....	136
• Cuchillas cortacésped adaptables.....	153-138
• Cuchillas desbrozadoras de ruedas Camon-Pubert.....	60
• Cuchillas motoazadas.....	50, 51

• Cuerda de arranque .....	107
• Depósitos de gasolina adaptables .....	168
➤ <b>DESBROZADORES MARUYAMA</b> .....	7-9
➤ <b>DESBROZADORES GASOLINA CAMON</b> .....	61, 62
➤ <b>DESBROZADORES DE RUEDAS CAMON-PUBERT</b> .....	57, 58
• Destornilladores carburadores .....	134
• Discos para desbrozador .....	178
• Ejes de transmisión .....	180, 181
• Embragues adaptables motosierras .....	32, 117, 118
• Embragues adaptables desbrozadores .....	20, 32, 117, 118
• Embragues tractores cortacésped adaptables .....	185
➤ <b>ESCARIFICADORES DE GASOLINA CAMON-PUBERT</b> .....	43
• Filtros de aceite adaptables .....	165, 166
• Filtros de aire adaptables .....	158-165
• Filtros de gasolina adaptables .....	171
• Fundas de barra .....	30
• Gafas y auriculares .....	126
➤ <b>GENERADORES</b> .....	68
• Grifos de gasolina adaptables .....	168
• Guantes de trabajo adaptables .....	131
➤ <b>HERRAMIENTAS DE PODA ARS</b> .....	69-71
• Herramientas de taller .....	133, 134
➤ <b>HILO DE NYLON</b> .....	176-177
➤ <b>HIDROLIMPIADORAS CAMON Y ACCESORIOS</b> .....	64-67
• Interruptores-contactores adaptables .....	169, 170
• Limas y mangos .....	68, 91
• Llaves de bujías .....	133
➤ <b>MÁQUINAS DE BATERÍA CAMON Y ACCESORIOS</b> .....	78, 79
• Membranas carburadores .....	111, 112
➤ <b>MOLINOS CEREALES Y ACCESORIOS</b> .....	80
➤ <b>MOTOAZADAS PUBERT-CAMON</b> .....	47-48
➤ <b>MOTOCULTORES CAMON</b> .....	49
➤ <b>MOTOBOMBAS</b> .....	67
➤ <b>MOTORES DE 4 TIEMPOS</b> .....	186
• Motores de arranque adaptables .....	186
➤ <b>MOTOSIERRAS DE GASOLINA MARUYAMA</b> .....	12
➤ <b>MOTOSIERRAS DE GASOLINA CAMON</b> .....	29
➤ <b>MOTOSIERRAS ELÉCTRICAS CAMON</b> .....	29
➤ <b>MOTOSIERRAS BATERÍA DE LITIO MARUYAMA</b> .....	14
• Muelles de embrague adaptables .....	32, 119
• Muelles de puesta en marcha adaptables .....	35, 106
➤ <b>MULTICUTTER MARUYAMA Y ACCESORIOS</b> .....	10
➤ <b>MULTICUTTER CAMON Y ACCESORIOS</b> .....	64
• Pasadores adaptables motoazadas .....	50
• Pasadores motoazadas Pubert-Camon .....	50
• Piñones barras .....	88
➤ <b>PODADOR TELESCÓPICO MARUYAMA</b> .....	10
➤ <b>PODADOR TELESCÓPICO CAMON</b> .....	63
• Poleas de puesta en marcha adaptables .....	35, 105
• Poleas tractores cortacésped adaptables .....	143
• Protectores hilo desbrozadores .....	132
➤ <b>PULVERIZADORES CAMON</b> .....	76
➤ <b>REBORDEADORES GASOLINA CAMON</b> .....	62
➤ <b>REBORDEADORES BATERÍA DE LITIO</b> .....	14
• Recambios y accesorios motosierras Maruyama .....	14, 15
• Recambios y accesorios desbrozadores Maruyama .....	16, 17
• Recambios y accesorios cortasetos Maruyama .....	17, 18
• Recambios y accesorios sopladores Maruyama .....	18, 19
• Recambios y accesorios motosierras Camon .....	30-38
• Retenes cigüeñal adaptables .....	121, 123
➤ <b>ROBOTS CORTACÉSPEDES</b> .....	74
• Rodamientos adaptables .....	121, 123
• Rodamientos ruedas cortacésped adaptables .....	122
• Rollos de cadena y accesorios .....	90
• Ropa de protección y accesorios .....	126-128
• Ruedas cortacésped Pubert .....	151
• Ruedas cortacésped Marina, Camon .....	43, 148, 149
• Ruedas cortacésped Simplicity-Snapper-Murray .....	149
• Ruedas cortacésped adaptables .....	147
• Sacos de tela y soportes saco cortacésped .....	43, 144
• Selenoides tractores cortacésped .....	173
• Sensores nivel aceite .....	166
• Silenciosos motores 2 y 4 tiempos .....	95
➤ <b>SOPLADORES DE GASOLINA MARUYAMA</b> .....	11
➤ <b>SOPLADORES DE GASOLINA CAMON</b> .....	63
• Soportes de cuchillas adaptables .....	140
• Tapas de cadena adaptables .....	31, 96
• Tapas de puesta en marcha adaptables .....	34, 102-105
• Tapones de aceite y gasolina adaptables .....	113, 114
• Tensores cadena adaptables .....	31, 97
➤ <b>TIJERAS DE BATERÍA Y SIERRAS</b> .....	71
• Tiradores de cuerda de p/m Maruyama .....	108
• Tiradores de cuerda de p/m Camon .....	108
• Tiradores de cuerda de p/m adaptables .....	107, 108
• Tornillos y tuercas adaptables para desbrozadores .....	179
➤ <b>TRACTORES CORTACÉSPED SIMPLICITY</b> .....	22-24
➤ <b>TRACTORES CORTACÉSPEDES CAMON, MA.RI.NA</b> .....	44
• Tracciones cortacésped MA.RI.NA .....	43
• Tracciones cortacésped Camon, DAYE .....	43
• Transmisiones motoazadas .....	57
• Triturador de gasolina Maruyama .....	13
• Tubos de gasolina y pasatubos .....	172
• Tubos de transmisión .....	180
• Tomas de admisión .....	112
➤ <b>VAREADORES CAMON Y ACCESORIOS</b> .....	28





Gama máquinas





**MARLYAMA**



**DESBROZADORAS DE GASOLINA**

	REFERENCIA	CILINDRADA	PESO	HERRAMIENTAS DE CORTE STANDARD	P.V.P SIN I.V.A.
 <p><b>NOVEDAD</b></p>	MX221-E 366280	22,5 cc	4,1 Kg	Empuñadura simple cabezal de nylon semiautomático 2 hilos	328,31
 <p><b>NOVEDAD</b></p>	MX271-E 366119	25,4cc	4,7 Kg	Empuñadura simple cabezal de nylon semiautomático 2 hilos	469,02
 <p><b>NOVEDAD</b></p>	MX271E-H 366120	25,4cc	5,0 Kg	Empuñadura doble cabezal de nylon semiautomático 2 hilos y disco de 4 puntas	469,02
	MX36 E 366139	35,0cc	6,2 Kg	Empuñadura simple cabezal de nylon semiautomático 2 hilos y disco de 4 puntas	573,09
 <p><b>NOVEDAD</b></p>	MX361EH 366288	35,0cc	6,6Kg	Empuñadura doble ajuste ergonómico cabezal de nylon semiautomático 2 hilos y disco de 3 puntas	598,00

## DESBROZADORAS DE GASOLINA CON REVERSE START

	REFERENCIA	CILINDRADA	PESO	HERRAMIENTAS DE CORTE STANDARD	P.V.P SIN I.V.A.
	<b>BC4322H-RS 365115</b>	41,5 cc	8,1 Kg	Empuñadura doble ajuste ergonómico cabezal de nylon semiautomático 2 hilos y disco de 3 puntas	624,32
	<b>BC5022H-RS 365113</b>	50,1cc	8,1 Kg	Empuñadura doble ajuste ergonómico cabezal de nylon semiautomático 2 hilos y disco de 3 puntas	697,75
	<b>BCV5021 364796</b>	50,1cc	8,7 Kg	Empuñadura doble ajuste ergonómico cabezal de nylon semiautomático 2 hilos y disco de 3 puntas	890,30

## DESBROZADORAS MOTOR HONDA 4T

	<b>BCGX35H 364145</b>	35,8 cc	5,7 kg	Empuñadura doble ajuste ergonómico cabezal de nylon semiautomático 2 hilos y disco de 4 puntas	613,01
--	---------------------------	---------	--------	---	--------



## DESBROZADORA TIPO MOCHILA 2T



REFERENCIA	CILINDRADA	PESO	HERRAMIENTAS DE CORTE STANDARD	P.V.P SIN I.V.A.
BKC5021 364793	50,1 cc	11,2 Kg	Empuñadura simple cabezal de nylon semiautomático 2 hilos y disco de 3 puntas	778,80

## ACCESORIOS PARA DESBROZADORAS > 30 y 50cc



REFERENCIA	DESCRIPCIÓN	P.V.P SIN I.V.A.
PU8100020601	Cultivador (4 fresas) >50cc Ancho de trabajo: 20 cm Profundidad: 5 cm	198,75
PU8100020602	Cultivador (2 fresas) >30cc Ancho de trabajo: 11 cm Profundidad: 5 cm	170,90

## CORTASETOS GASOLINA 2T



REFERENCIA	CILINDRADA	PESO	HERRAMIENTAS DE CORTE STANDARD	P.V.P SIN I.V.A.
HT238P 362440	22,5 cc	5,2 Kg	Cuchilla simple en acero cromado. Ancho de corte: 60 cm Separación entre cuchillas: 25 mm	566,26
HT237D 362479	22,5 cc	4,6 Kg	Cuchillas dobles en acero cromado. Ancho de corte: 60 cm. Separación entre cuchillas: 25 mm. Asa trasera giratoria 180°	444,46
HT239D 362442	22,5 cc	5,2 Kg	Cuchillas dobles en acero cromado. Ancho de corte: 60 cm. Separación entre cuchillas: 25 mm. Sistema antivibración Asa trasera giratoria 180°	564,26
HT239DL 362443	22,5 cc	5,3 Kg	Cuchillas dobles en acero cromado Ancho de corte: 70 cm. Separación entre cuchillas+: 25 mm. Sistema antivibración Asa trasera giratoria 180°	608,55

## MULTICUTTER GASOLINA 2T



REFERENCIA	CILINDRADA	PESO	DESCRIPCIÓN	P.V.P SIN I.V.A.
<b>MC2630 RS 364566</b>	25,4 cc	4,8 Kg	Empuñadura simple * No incluye accesorios	414,78

## ACCESORIOS MULTICUTTER



<b>MCA-S 364515</b>	El accesorio de Rebordeador MC-S equipado con una transmisión de acero y un codo de engranajes muy robusto.	118,42
<b>MCA-E 364514</b>	El accesorio de perfilador presenta una cuchilla de 195 mm de alta resistencia, diseño de protección abierta y sencillo ajuste de profundidad.	131,34
<b>MCA-HTS 364520</b>	El accesorio del cortasetos articulado MC-HTS presenta un cabezal de 180° y cuchillas dobles alternas de doble cara de 400 mm	420,62
<b>MCA-HTSL 364519</b>	El accesorio del cortasetos articulado MC-HTS presenta un cabezal de 180° y cuchillas dobles alternas de doble cara de 600 mm	460,45
<b>MCA-T 364516</b>	El accesorio de fresa MC-T presenta dos fresas con seis cuchillas montadas sobre una transmisión muy robusta.	312,04
<b>MCA-PS 364517</b>	El accesorio de motosierra MC-P le permite podar a 4,0 m de altura.	347,11
<b>237955</b>	Extensión de 45 cm	69,67

## PODADOR TELESCÓPICO



REFERENCIA	CILINDRADA	PESO	DESCRIPCIÓN	P.V.P SIN I.V.A.
<b>TPP2630 364588</b>	25,4 cc	6,5 Kg	Longitud de tubo: 2.750mm / 3.950mm  Barra de corte: 10"25cm	784,80

## PODADOR



REFERENCIA	CILINDRADA	PESO	DESCRIPCIÓN	P.V.P. SIN I.V.A.
PP2430 364669	22,5 cc	4,6 Kg	Podador, barra de corte 10"25cm Longitud: 2050mm	697,60

## SOPLADORES MOTOR GASOLINA 2T



REFERENCIA	CILINDRADA	PESO	DESCRIPCIÓN	P.V.P. SIN I.V.A.
BL3110 395816	30,1 cc	4,3 kg	Caudal máx. aire: 13 m <sup>3</sup> /min Vel. máx. aire: 72,1 m <sup>3</sup> /seg.	390,32
395750			Kit aspiración soplador BL3100	85,71



BL8600 SP 395887	60,9	9,4 Kg	Caudal max. aire 18,2m <sup>3</sup> /min Vel. max.aire 80,2 m <sup>3</sup> /seg.	762,35
BL9000 395867	79,2 cc	10,9 Kg	Caudal máx. aire: 28,3 m <sup>3</sup> /min Vel. máx. aire: 82,7 m <sup>3</sup> /seg.	819,71

**MOTOSIERRAS GASOLINA 2T**

	REFERENCIA	CILINDRADA	PESO	DESCRIPCIÓN	P.V.P SIN I.V.A.
	MCV3101TS 362841	30cc	3,1kg	10"/25 cm 3/8 BP	379,38
	MCV3101TS-Q 362930	30cc	3,1kg	10"/25 cm 1/4"	409,39
	MCV 3900 362904	38cc	3,5kg	12/30cm	455,62
	MCV3101S 362844	30cc	3,4 Kg	14"/35 cm	437,38
	MVC3501S 362850	35cc	4,2kg	16"/41 cm	488,75
	MCV4000 362906	39c	3,8kg	14"/35cm	467,50
	MCV5100S 389535	50cc	5,4kg	18"/45cm	668,90
	MCV5600 362909	56cc	5,6kg	18"/45cm	705,44
	MCV6200 362911	62cc	5,6kg	20"/50cm	754,08

## TRITURADOR DE GASOLINA



REFERENCIA	POTENCIA	PESO	DESCRIPCIÓN	P.V.P SIN I.V.A.
<b>HNJ-132-EU 389547</b>	9,5 KW 13,0 HP	450 kg	Triturador motor Mitsubishi BG400LE diámetro max. Ramas 135mm, 2 cuchillas, 8 martillos	18.385,00

## MOTOBOMBA GASOLINA



REFERENCIA	CILINDRADA	PESO	DESCRIPCIÓN	P.V.P SIN I.V.A.
<b>MP2524</b>	23 cc	4,5 Kg	Caudal máx:120L/min Aspiración máx: 8m Altura máx: 38m Diámetro salida: 1"/25,4mm	376,12

## PULVERIZADOR GASOLINA



REFERENCIA	CILINDRADA	PESO	DESCRIPCIÓN	P.V.P SIN I.V.A.
<b>MS0835W 353145</b>	24 cc	8,5 Kg	Caudal max: 8 L/min Capacida dep. 13L Presión Max: 3,7Bares	865,39

## AHOYADOR MOTOR GASOLINA 2T











REFERENCIA	CILINDRADA	PESO	DESCRIPCIÓN	P.V.P SIN I.V.A.
<b>MAG501RS 364844</b>	49,9 cc	10,4 Kg	Ø Eje salida 20 mm Ø max. broca 200 mm <b>No incluye broca</b>	859,13
<b>ML111111</b>			Adaptador broca 25 mm	38,75

**BARRAS MOTOSIERRAS MARUYAMA - OREGON**







REFERENCIA	TAMAÑO / PASO	Nº GUÍAS	MODELO	P.V.P SIN I.V.A.
ML285766	Barra 10" 3/8LP 1,3 mm	40DL	MCV3100TS/MCV3101TS	36,62
ML247946	Barra 10" 1/4 1,1 mm	60DL	MCV3101TS-Q	50,55
ML286828	Barra 14" 3/8LP 1,3 mm	52DL	MCV3100S/MCV3101S	46,75
523653	Barra 16" 3/8LP 1,3 mm	57DL	MCV3501S	29,95
120SXEA041	Barra 12" 3/8LP 1,3mm	45DL	MVC3900	33,90
140SXEA041	Barra 14" 3/8LP 1,3mm	52DL	MCV4000	36,90
523700	Barra 18" 3/8LP 1,5mm	72DL	MVC5600	39,75
208VXLHK095	Barra 20" 3/8LP 1,5mm	72DL	MVC6200	51,90



## CILINDRO, PISTÓN Y CIGÜEÑAL MOTOSIERRAS MARUYAMA

MODELO		 CILINDRO	 PISTÓN	 SEGMENTO	 BULÓN PISTÓN	 CLIP BULÓN	 COJINETE	 JUNTA CILINDRO	 CIGÜEÑAL
MCV3100S MCV3100TS	Ref.	ML287010	ML285049	ML285590	ML285591	ML261576	ML261037	ML285541	ML285599
	P.V.P.	63,44	28,26	5,19	2,79	0,49	6,39	1,29	112,24
MCV3101S MCV3101TS	Ref.	ML279300	ML278398	ML285590	ML285591	ML261576	ML285624	ML278403	ML285599
	P.V.P.	142,67	31,46	5,19	2,79	0,49	16,33	3,79	112,24
MCV3501S	Ref.	ML272688	ML285876	ML285880	ML285881	ML285883	ML285882	ML275220	ML285867
	P.V.P.	108,81	31,78	5,79	3,29	0,49	10,32	8,51	148,83
MCV4200S	Ref.	ML195131202 (Completo)	ML195132100 (Completo)	ML195132020	ML195132030	ML195132050	ML962211007	ML195131130	195120300
	P.V.P.	-	-	-	-	-	-	-	-
MCV5100S	Ref.	ML181130217 (Completo)	ML181132064 (Completo)	ML181132080	ML181132090	ML181132050	ML962210033	ML181131133	181120102
	P.V.P.	-	-	-	-	-	-	-	-

## RECAMBIO MOTOSIERRAS MARUYAMA

MODELO		 CAMPANA EMBRAGUE	 EMBRAGUE	 BOMBA ENGRASE	 ELECTRÓNICO	 CARBURADOR	 TAPA CADENA	 TAPA P/M CPL
MCV3100S	Ref.	ML286238	ML285535	ML286811	ML285556	ML285643	ML287389	ML285577
	P.V.P.	28,74	21,73	40,80	78,59	-	72,14	54,47
MCV3100TS	Ref.	ML285546	ML285535	ML286816	ML285556	ML285643	ML287044	ML285577
	P.V.P.	59,77	21,73	40,80	78,59	-	71,90	54,47
MCV3101S MCV3101TS	Ref.	ML286238	ML285535	ML286811	ML289548	ML289500	ML287389	ML285577
	P.V.P.	28,74	21,73	40,80	61,43	153,12	72,14	54,47
MCV3501S	Ref.	ML285896	ML285915	ML272830	ML274027	ML274865	ML285958	ML285940
	P.V.P.	28,99	37,26	54,32	64,93	165,19	17,11	55,13
MCV4200S	Ref.	ML181223314	ML175180101	ML179245202	ML195143200	ML195153201	ML195213900	ML195160900
	P.V.P.	-	-	-	-	-	-	-
MCV5100S	Ref.	ML181223062	ML175180101	ML181245251	ML181143212	ML181153101	ML957213900	ML181160900
	P.V.P.	-	-	-	-	-	-	-

## RECAMBIO MOTOSIERRAS MARUYAMA









MODELO		CILINDRO + PISTÓN	CAMPANA	EMBRAGUE	BOMBA ENGRASE	ELECTRÓNICO	CARBURADOR	TAPA CADENA
MCV3900 MCV4000	Ref.	ML036610	ML035989	ML036023	ML035895	ML035939	ML036422	ML036189
	P.V.P.	159,80	39,75	44,89	72,38	75,75	119,75	52,85
MCV5600	Ref.	ML036672	ML035358	ML035143	ML035393	ML036026	ML035814	ML036552
	P.V.P.	278,60	52,98	43,88	41,57	70,95	114,80	52,65
MCV6200	Ref.	ML036673	ML035932	ML035143	ML035393	ML036026	ML035814	ML036552
	P.V.P.	288,55	52,98	43,88	43,88	70,95	114,89	52,65

**ACCESORIOS DESBROZADORAS MARUYAMA**









MODELO		CABEZAL	CODO	ARNÉS	ELECTRÓNICO	ARRANCADOR	TUBO	TRANSMISIÓN
M42SH-RS	Ref.	ML226182	ML234835	ML228086	ML267579	ML280838	ML217900	ML217897
M50SH-RS	P.V.P.	47,11	165,45	47,79	77,37	104,24	64,15	26,08
M50BKC	Ref.	ML226182	ML236695	ML226490	ML267579	ML263525	ML220786	ML216965
	P.V.P.	47,11	194,04	115,34	77,37	36,18	62,68	32,91
BK5020	Ref.	ML230916	ML236695	ML226490	ML282289	ML285684	ML220786	ML216965
	P.V.P.	39,75	194,04	115,34	71,65	62,58	62,68	32,91
BC2300RS	Ref.	ML229874	ML232070	ML220533	ML280470	ML282404	ML224123	ML226399
	P.V.P.	34,81	100,28	13,05	60,45	41,00	75,22	18,95
BC4320H	Ref.	ML230916	ML234835	ML219612	ML282289	ML285684	ML217900	ML217897
	P.V.P.	39,75	165,45	60,19	71,65	62,58	64,15	26,08
BC4320H-RS	Ref.	ML227409	ML234835	ML219612	ML282289	ML282294	ML217900	ML217897
	P.V.P.	47,81	165,45	60,19	71,65	114,14	64,15	26,08
BC500H	Ref.	ML226182	ML234835	ML219612	ML267579	ML262624	ML217900	ML217897
	P.V.P.	47,11	165,45	60,19	71,65	30,79	64,15	26,08
BC5020H	Ref.	ML230916	ML234835	ML219612	ML282289	ML285684	ML217900	ML217897
	P.V.P.	39,75	165,45	60,19	71,65	62,58	64,15	26,08
BC5020H-RS	Ref.	ML227409	ML234835	ML219612	ML282289	ML282294	ML217900	ML217897
	P.V.P.	47,81	165,45	60,19	71,65	114,14	64,15	26,08
BCV5020	Ref.	ML232906	ML232060	ML234477	ML287794	ML287918	ML231923	ML230703
	P.V.P.	33,71	177,27	129,31	70,01	125,90	44,54	24,78
MX24	Ref.	ML232225	ML232070	ML220533	ML280470	ML280419	ML224123	ML226399
	P.V.P.	30,61	100,28	13,05	61,43	17,39	75,22	18,95
MX27/MX27H	Ref.	ML232226	ML231880	ML220533	ML285325	ML280419	ML218711	ML219268
	P.V.P.	31,12	115,80	13,05	64,24	17,39	56,15	21,97
MX33/MX33H	Ref.	ML232226	ML231880	ML220533	ML267400	ML261420	ML218711	ML219268
	P.V.P.	31,12	115,80	13,05	63,66	23,93	56,15	21,97
BC421H-RS	Ref.	ML234860	ML234835	ML228086	ML267579	ML280838	ML217900	ML217897
BC501H-RS	P.V.P.	33,71	165,45	47,79	77,37	104,24	64,15	26,08
MX36E	Ref.	ML231202	ML560565	ML560583	ML246195	563607	560550	560515
MX36EH	P.V.P.	29,09	80,99	33,98	-	21,10	44,86	31,42
BC4321H-RS	Ref.	ML234901	ML234835	ML228086	ML287598	ML285810	217900	ML217897
	P.V.P.	49,65	165,45	47,79	83,17	48,43	64,15	26,08
BC5021H-RS	Ref.	ML239350	234835	228086	279547	285810	217900	217897
	P.V.P.	52,75	165,45	47,79	34,81	48,43	64,15	26,08
BCV5021	Ref.	ML239350	232060	234477	279547	285810	231923	230703
	P.V.P.	52,75	177,27	129,31	34,81	48,43	44,54	24,78
BC4322H-RS	Ref.	ML234901	234835	228086	287598	286919	217900	217897
	P.V.P.	49,65	165,45	47,79	83,17	108,98	64,15	26,08
BC5022H-RS	Ref.	234901	234835	228086	279547	286919	217900	217897
	P.V.P.	49,65	165,45	47,79	34,81	108,98	64,15	26,08
MX221E	Ref.	232226	241689	220533	277798	280419	560425	226546
	P.V.P.	31,12	84,85	13,05	36,23	23,94	29,41	20,07
MX271E	Ref.	234899	245121	220533	277798	280419	560396	227831
	P.V.P.	22,44	-	13,05	36,23	23,94	88,22	20,85
MX22E	Ref.	232226	241689	560229	277798	563307	560425	560375
	P.V.P.	31,12	84,85	13,05	36,23	17,36	29,58	20,85







## CILINDRO, PISTÓN Y CIGÜEÑAL DESBROZADORAS MARUYAMA

MODELO		 CILINDRO	 PISTÓN	 SEGMENTO	 BULÓN PISTÓN	 CLIP BULÓN	 COJINETE	 JUNTA CILINDRO	 CIGÜEÑAL
M23S	Ref.	ML268005	ML268032	ML264891	ML261036	ML261576	ML263957	ML268070	ML268187
	P.V.P.	32,71	12,90	4,39	2,35	0,49	6,99	1,10	-
M23CS-RS BC2300RS	Ref.	ML266249	ML263569	ML263789	ML261036	ML261576	ML263957	ML283420	ML267193
	P.V.P.	77,27	21,22	4,39	2,35	0,49	6,99	1,32	65,64
M26S-RS M26SH-RS	Ref.	ML264989	ML265012	ML261496	ML261497	ML261576	ML261037	ML265001	ML265197
	P.V.P.	90,04	22,39	4,89	2,47	0,49	6,40	3,09	100,30
M30SH	Ref.	ML268687	ML268782	ML265067	ML265068	ML261393	ML265225	ML268231	ML265141
	P.V.P.	89,95	24,28	4,52	2,91	0,49	7,55	1,10	49,75
M321MC M32SH-RS BC320H BC320H-RS	Ref.	ML247663	ML273263	ML261390	ML261555	ML261393	ML261392	ML261528	ML261395
	P.V.P.	102,92	24,50	4,69	3,64	0,49	6,99	2,44	106,39
BC4320H BC4320H-RS	Ref.	ML247669	ML265227	ML262476	ML262749	ML262479	ML262659	ML282259	ML283038
	P.V.P.	124,97	43,47	5,26	3,79	0,59	8,14	1,32	106,46
M50SH-RS M50BKC BC500H	Ref.	ML281407	ML264003	ML264005	ML262749	ML262479	ML262659	ML262546	ML283038
	P.V.P.	149,19	26,60	5,01	3,79	0,59	8,14	1,81	106,46
BKC5020 BC5020H BC5020H-RS	Ref.	ML283076	ML283675	ML282941	ML262749	ML262479	ML262659	ML282259	ML283038
	P.V.P.	149,19	28,26	5,19	3,79	0,59	8,14	1,32	106,46
BCV5020	Ref.	ML283076	ML283675	ML282941	ML262749	ML262479	ML262659	ML282259	ML283038
	P.V.P.	149,19	28,26	5,19	3,79	0,59	8,14	1,32	106,46
BC4322H-RS	Ref.	246913	285795	262476	262749	262479	262659	279101	285797
	P.V.P.	-	24,82	5,26	3,79	0,59	8,14	7,41	106,83
BC5022H-RS	Ref.	246925	246091	282941	262749	262479	262659	288171	285797
	P.V.P.	197,76	47,69	5,19	3,79	0,59	8,14	6,43	106,83
MX221E	Ref.	247684	272204	264891	261036	261576	288520	289643	267193
	P.V.P.	56,60	29,58	4,39	2,35	0,49	5,39	1,79	65,64
MX271E	Ref.	247668	273155	261496	261497	261576	261037	282330	277939
	P.V.P.	53,81	29,75	4,89	2,47	0,49	6,40	1,89	69,75
MX22E	Ref.	278641	272204	264891	261036	261576	288520	289643	267193
	P.V.P.	109,79	29,58	4,39	2,35	0,49	5,39	1,79	65,64

## CILINDROS, PISTÓN Y CIGÜEÑAL CORTASETOS MARUYAMA

MODELO		 CILINDRO	 PISTÓN	 SEGMENTO	 BULÓN PISTÓN	 CLIP BULÓN	 COJINETE	 JUNTA CILINDRO	 CIGÜEÑAL
M23HDS M23HDS-R	Ref.	ML264981	ML263569	ML263789	ML261036	ML261576	ML263957	ML263770	ML264643
	P.V.P.	109,79	21,22	4,38	2,35	0,49	6,99	1,20	101,52
HT2350D-RX HT236DSV-R HT236DLSV-R	Ref.	ML283149	ML283265	ML263789	ML281185	ML261576	ML261037	ML283177	ML283155
	P.V.P.	109,79	20,66	4,38	2,20	0,49	6,40	1,59	83,73

## ACCESORIOS CORTASETOS MARUYAMA





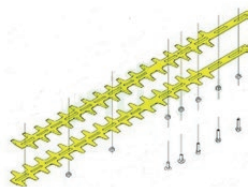



MODELO	 					
	CUCHILLA SUPERIOR	CUCHILLA INFERIOR	ELECTRÓNICO	ARRANCADOR	BIELA	
M23HDS	Ref.	ML581913	ML570688	ML267400	ML280719	ML271466
	P.V.P.	96,44	73,12	63,66	154,18	51,89
M23HDLS-R	Ref.	ML582446	ML582428	ML267400	ML280719	ML271466
	P.V.P.	107,67	86,57	63,66	154,18	51,89
HT2350D-RX	Ref.	ML270682	ML270682	ML283165	ML283170	ML271225
	P.V.P.	50,70	50,70	95,56	16,75	33,04
HT236DSV-R	Ref.	ML271468	ML271468	ML283165	ML283172	ML271466
	P.V.P.	84,74	84,78	95,56	36,51	51,89
HT236DLSV-R	Ref.	ML278706	ML278706	ML283165	ML283172	ML271466
	P.V.P.	84,78	84,78	95,56	36,51	51,89
HT237D	Ref.	ML270682	ML270682	ML278293	ML278207	ML271225
	P.V.P.	50,70	50,70	60,70	53,97	33,04
HT239D	Ref.	ML278703	ML278703	ML278293	ML278177	ML271466
	P.V.P.	71,41	71,41	60,70	64,61	51,89
HT239DL	Ref.	ML278706	ML278706	ML278293	ML278177	ML271466
	P.V.P.	73,84	73,84	60,70	64,61	51,89
HT238P	Ref.	ML279080	ML279081	ML278293	ML278177	ML271466
	P.V.P.	80,75	69,91	60,70	64,61	51,89

## KITS CUCHILLAS CORTASETOS MARUYAMA



MODELO	DESCRIPCIÓN	P.V.P.
ML469279	Kit cuchillas + tornillos + arandelas + tuercas HT2350DX / HT237D	94,26
ML469280	Kit cuchillas + tornillos + arandelas + tuercas HT239D	140,27
ML469282	Kit cuchillas + tornillos + arandelas + tuercas HT236DLSV / HT239DL	167,28
ML469278	Kit cuchillas + tornillos + arandelas + tuercas HT238P	135,68

## ACCESORIOS SOPLADORES MARUYAMA

MODELO	       								
	CILINDRO	PISTÓN	SEGMENTO	BULÓN PISTÓN	CLIP BULÓN	COJINETE	JUNTA CILINDRO	CIGÜEÑAL	
BL3110	Ref.	ML286791	ML268782	ML265067	ML265068	ML261393	ML265225	ML286846	ML265141
	P.V.P.	196,01	24,28	4,52	2,91	0,49	7,55	8,26	49,75
BL6700SP	Ref.	ML637459	ML627497	ML627498	ML944769	ML943307	ML597289	ML637460	ML634426
	P.V.P.	242,53	59,78	24,15	7,60	1,02	18,18	11,74	-
BL8100SP	Ref.	ML649312	ML649321	ML649323	ML649322	ML943307	ML649325	ML426074	ML649326
	P.V.P.	255,90	52,78	26,92	27,56	1,02	11,65	6,53	-
BL8200SP	Ref.	ML649312	ML649321	ML649323	ML649322	ML943307	ML649325	ML426074	ML649326
	P.V.P.	255,90	52,78	26,92	27,56	1,02	11,65	6,53	-
BL8500SP	Ref.	ML649312	ML426080	ML426081	ML649322	ML419536	ML649325	ML426074	ML426082
	P.V.P.	255,90	68,67	26,92	27,56	0,71	11,65	6,53	-
BL8600	Ref.	ML279708	ML278872	279736	278924	276122	278471	279737	278873
	P.V.P.	-	33,86	4,94	11,32	0,49	9,58	5,26	142,23
BL9000	Ref.	ML275765	ML277475	ML649323	ML278019	ML276122	ML278471	ML275760	ML276123
	P.V.P.	-	32,83	26,92	7,85	0,49	9,58	6,11	134,26

## ACCESORIOS SOPLADORES MARUYAMA

MODELO		TURBINA	TAPA P/M CPL	ELECTRÓNICO	CARBURADOR	SILENCIOSO	DEPÓSITO
BL3100	Ref.	ML281874	ML281988	ML282010	ML282528	ML282585	ML281587
BL3110	P.V.P.	11,47	18,41	75,97	-	34,05	17,53
BL5100SP	Ref.	ML118724	ML649375	ML400914	ML649701	ML400917	ML120154
	P.V.P.	26,04	84,63	116,61	-	51,95	20,07
BL6500SP	Ref.	ML118724	ML998413	ML597262	ML634429	ML634431	ML120154
	P.V.P.	26,04	92,58	59,75	70,95	-	20,07
BL6700SP	Ref.	ML118724	ML998413	ML597262	ML634429	ML636763	ML120154
	P.V.P.	26,04	97,82	-	70,95	-	20,07
BL8100SP	Ref.	ML128908	ML649375	ML415371	ML649344	ML649357	ML120154
	P.V.P.	38,53	84,63	-	-	-	20,07
BL8200SP	Ref.	ML128908	ML649375	ML415371	ML649344	ML649357	ML127707
	P.V.P.	38,53	84,63	-	-	-	17,48
BL8500SP	Ref.	ML128908	ML426346	ML426410	ML649344	ML426106	ML127707
	P.V.P.	38,53	113,06	-	-	120,06	17,48
BL8600	Ref.	ML275874	ML279023	ML279505	ML248002	ML248358	ML277090
	P.V.P.	29,19	104,41	74,61	108,93	25,60	35,79
BL9000	Ref.	ML275874	ML276131	ML267401	ML276045	ML278384	ML277090
	P.V.P.	29,19	53,88	58,60	141,18	30,14	35,79

## ADAPTADORES CABEZALES MARUYAMA

	REFERENCIA	DESCRIPCIÓN	P.V.P SIN I.V.A.
1	ML231933	(1) Espárrago M8 X 1.25 X 33 (L) para cabezal ML232226	5,40
2	ML638091	(1) Espárrago M8 X 1.25 X 40 (L) para cabezal ML226182	4,81
	ML411353	(2) Espárrago M8-M10 X 1.25 (L) para cabezal ML227409	22,12
3	ML231658	(3) Espárrago M8 - M14 X 1.25 para cabezal ML230916	12,36

## TRIMMYS MARUYAMA

	REFERENCIA	DESCRIPCIÓN	P.V.P SIN I.V.A.
1	ML232226	(1) Trimmy MX27H / MX22E / MX221E / MX33 / MX33H / MX24 · Ø 8 mm x 1.25	31,12
2	ML226182	(2) Trimmy Ø 8 mm x 1.25	47,11
3	ML227409	(3) Trimmy Ø 10 mm x 1.25	47,81
4	ML229902	(4) Trimmy Ø 8 mm x 1.25	36,64
5	ML230916	(5) Trimmy Ø 14 mm x 1.50	39,75
6	ML229874	(6) Trimmy Ø 8 mm x 1.25	34,81
7	ML239350	(7) Trimmy carga rápida BCV5020/BCV5021 Ø 12 mm x 1.25	52,75
8	ML234901	(7) Trimmy carga rápida BC4321H / BC5021H Ø 10 mm x 1.25 BC4322H-RS / BC5020H-RS	49,65
9	ML232906	(8) Trimmy BCV5020 Ø 12 mm x 1.25	33,71
10	ML234860	(8) Trimmy BC5020H / BC501H / BC421H Ø 10 mm x 1.25	33,71
11	ML231202	(9) Trimmy MX24E / MX36E / MX36EH Universal	29,09
	ML468138	(10) Trimmy Ø 10 mm x 1.25 Maruyama	34,22
	ML232225	(11) Trimmy Ø 8 mm x 1.25 - MX24 / MX27 / MX33	30,61
	ML234899	Trimmy MX271E	22,44

## KITS CARBURADORES



REFERENCIA	DESCRIPCIÓN	P.V.P SIN I.V.A.
ML247881	Carburador Kit HT237D/HT239D/HT238P	50,75
ML247873	Carburador Kit MX24E	84,71
ML247875	Carburador Kit MX27/MX27H	87,22
ML247877	Carburador Kit MX27E/MX37EH	85,67
ML247855	Carburador Kit MX33/MX33H	134,09
ML247880	Carburador Kit MX36E/MX36EH	48,92
ML247859	Carburador Kit BC420H/BC421H	97,77
ML247878	Carburador Kit BC4320H/BC5020H	110,37
ML246927	Carburador Kit BKC5021RS/BC5021H/BCV5021/MAG501	89,35
ML246916	Carburador Kit BC4321H-RS / BC4322H-RS / BC5022H-RS	128,67

## KITS EMBRAGUES



REFERENCIA	DESCRIPCIÓN	P.V.P SIN I.V.A.
ML247660	Embrague kit HT2350D/HT236DLSV/HT237D/HT239D	-
ML246924	Embrague kit MX27/MX27H 7 MX24E / MX27E / MX27EH MX221E / MX271E	28,75
ML246919	Embrague kit MX33/MX33H	23,66
ML246912	Embrague kit BC4320H / BC4321H / BC5020H / BC5021H / BCV5021 MX36E / MX36EH / BC4322H-RS / BC5022H-RS	32,75

## CILINDROS + JUNTAS



REFERENCIA	DESCRIPCIÓN	P.V.P SIN I.V.A.
ML247690	Cilindro + Junta HT237/HT239D/HT239DL	94,68
ML247684	Cilindro + Junta MX24E / MX221E	56,60
ML247686	Cilindro + Junta MX27/MX27H	77,62
ML247688	Cilindro + Junta MX27E / MX27EH / MX271E	54,95
ML247663	Cilindro + Junta MX33/MX33H	102,92
ML247661	Cilindro + Junta MX36E/MX36EH	104,19
ML247665	Cilindro + Junta M42SH/BC420H/BC4321H/BC421H	125,38
ML247669	Cilindro + Junta BC4320H	124,97
ML246913	Cilindro + Junta BC4321H-RS / BC4322H-RS	-
ML247667	Cilindro + Junta M50BKC/BC500H/BC501H HUSQV:153R	128,34
ML246925	Cilindro + Junta BKC5021RS/BC5021H/BCV5021 / BC5022H-RS	197,76

## KIT JUNTAS CARBURADOR



REFERENCIA	DESCRIPCIÓN	P.V.P SIN I.V.A.
ML247867	Kit juntas Carburador HT237/HT239D/HT239DL/MX24E/MX27E/ MX27EH	45,67
ML247853	Kit juntas Carburador BC320H/MX33/MX33H	49,67
ML247861	Kit juntas Carburador BC421H/BC420H-RS	43,86
ML246918	Kit juntas Carburador BC4321H-RS	45,67

## KITS TUBOS GASOLINA+FILTRO



REFERENCIA	DESCRIPCIÓN	P.V.P SIN I.V.A.
ML247864	Kit tubos Gasolina+filtro MX33/MX33H/BC320H HUSQV:133R/MX24E HT237/HT239/MX27E/MX27EH/MX221E/MX271E	12,42
ML246922	Kit tubos Gasolina+filtro MX36E/MX36EH	39,06
ML247857	Kit tubos Gasolina+filtro BC500H/BC501H HUSQV:153R	15,62
ML246915	Kit tubos Gasolina+filtro BC4321H/BC5021 BC5021H/MAG501RS/BCK5021/BC4322H-RS/BC5022H-RS	-
ML247879	Kit tubos Gasolina+filtro BKC5020/BC5020H/BCV5020	17,83

## KITS PISTÓN



REFERENCIA	DESCRIPCIÓN	P.V.P SIN I.V.A.
ML247683	Kit Pistón HT237D/HT239D/HT239DL/HT236	28,86
ML247685	Kit Pistón MX24E / MX221E	39,87
ML247687	Kit Pistón MX27/MX27H	35,25
ML247689	Kit Pistón MX27E/MX27EH / MX271E	35,25
ML247664	Kit Pistón MX33/MX33H/BC5320H	38,53
ML247662	Kit Pistón MX36E/MX36EH	29,31
ML247666	Kit Pistón M42SH/BC4321H/BC420H/BC421H	48,13
ML246914	Kit Pistón BC4321H-RS/BC4322H-RS	47,68
ML247668	Kit Pistón M50BKC/BC501H/BC500H HUSQV:153R	42,17
ML246926	Kit Pistón BKC5021RS/BC5021H/BCV5021/MAG501RS/BC5022H-RS	51,07
ML247671	Kit Pistón BC5020H/BCV5020/BKC5020	43,83

**TRACTORES CORTACÉSPED**



REFERENCIA

CARACTERÍSTICAS

P.V.P  
SIN I.V.A.

**SZT105  
2692021**

Motor/Potencia: B&S Serie 7200 Bicilíndrico  
Ancho de corte: 92 cm  
Nº de cuchillas: 2  
Transmisión: hidrostática  
Alturas de corte: 7/38-110 mm  
Peso: 251 kg  
No incluye el kit de salida

5.402,99

**1697523**

Kit salida trasera

346,27

**1697524**

Kit salida lateral

247,26



**SZT175  
2691923**

Motor/Potencia: B&S Serie 7200 Bicilíndrico  
Ancho de corte: 107 cm  
Nº de cuchillas: 2  
Transmisión: hidrostática  
Alturas de corte: 13-38 mm  
Peso: 251 kg  
No incluye el kit de salida

6.231,34

**1697447**

Kit salida trasera

416,42

**1697446**

Kit salida lateral

319,40



**SZT275  
2691922**

Motor/Potencia: B&S SERIE 8240 Bicilíndrico  
Ancho de corte: 52"-122 cm  
Nº de cuchillas: 3  
Transmisión: hidrostática  
Alturas de corte: 13/38-110 mm  
Peso: 315 kg  
No incluye el kit de salida

7.947,76

**1697449**

Kit salida trasera

464,18

**1697448**

Kit salida lateral

355,22



**SZT350  
2691696**

Motor/Potencia: B&S SERIE 8270  
Bicilíndrico/27HP  
Ancho de corte: 52"-132 cm  
Nº de cuchillas: 3  
Transmisión: hidrostática  
Alturas de corte: 38 - 115 mm  
Peso: 315 kg  
Descarga: Lateral

8.679,10

**TRACTORES CORTACÉSPED**



**SLC92**  
2692050

Motor/Potencia: B&S 7160 V-Twin  
Ancho de corte: 92 cm.  
Nº de cuchillas: 2  
Transmisión: Hidrostática  
Alturas de corte: 25-80mm  
Peso: 226 Kg  
Descarga: Trasera  
Capacidad recogedor: 300 Litros

5.255,22



**SLC102**  
2692051

Motor/Potencia: B&S 7220 V-Twin  
Ancho de corte: 102 cm.  
Nº de cuchillas: 2  
Transmisión: Hidrostática  
Alturas de corte: 25-80mm  
Peso: 255 Kg  
Descarga: Trasera  
Capacidad recogedor: 300 Litros

5.838,81



**SYC102**  
2692052

Motor/Potencia: B&S 8240 V-Twin  
Ancho de corte: 102cm.  
Nº de cuchillas: 2  
Transmisión: Hidrostática  
Alturas de corte: 25-80mm  
Peso: 271 Kg  
Descarga: Trasera  
Capacidad recogedor: 320 Litros

6.826,87



**SYC122**  
2692053

Motor/Potencia: B&S 8270 V-Twin  
Ancho de corte: 122 cm.  
Nº de cuchillas: 2  
Transmisión: Hidrostática  
Alturas de corte: 25-80mm  
Peso: 295 Kg  
Descarga: Trasera  
Capacidad recogedor: 380 Litros

7.750,75

**TRACTORES CORTACÉSPED**



REFERENCIA

**SRD 360  
2691688**

CARACTERÍSTICAS

Motor/Potencia: B&S Serie 8270/27HP  
Intek V- Twin OHV  
Ancho de corte: 107 cm.  
Nº de cuchillas: 2  
Transmisión: Hidrostática  
Alturas de corte: 25-80mm  
Peso: 270 Kg / Descarga: Trasera  
Capacidad recogedor: 350 Litros  
SUSPENSIÓN A LAS CUATRO RUEDAS  
Incluye tapón mulching  
Parachoques delantero

P.V.P  
SIN I.V.A.

7.875,00

**CORREAS TRACTORES CORTACÉSPED SIMPLICITY**



REFERENCIA	DESCRIPCIÓN	CORTE	MODEL Nº	MODELOS	P.V.P SIN I.V.A.
SY1737441YP	Correa tracción	42"/107cm	2691218	SLT100	-
SY1732955SM	Correa cuchillas	42"/107cm	2691218	SLT100	-
SY1728008SM	Correa tracción	46"/118cm	2691262	SLT200	-
SY1732956SM	Correa cuchillas	46"/118cm	2691262	SLT200	-
SY885895YP	Correa 1ª cigüeñal	38"/96cm	2691263	SRD100	-
	Correa 1ª cigüeñal	42"/107cm	2691265	SRD300	-
SY885495YP	Correa 2ª tracción	38"/96cm	2691263	SRD100	-
	Correa 2ª tracción	42"/107cm	2691265	SRD300	-
SY1758762YP	Correa cuchillas	38"/96cm	2691263	SRD100/210	-
SY1758760YP	Correa cuchillas	42"/107cm	2691263	SRD300/310/360	-
SY84001118	Correa tracción		2691688	SRD210/310/360	-
SY1758100YP	Correa tracción	42"/107 cm	2691923	SZT175	-
SY1758101YP	Correa cuchillas	42"/107 cm	2691923	SZT175	-
SY885714YP	Correa tracción	48"/122 cm	2691922	SZT275	-
SY84003367	Correa cuchillas	48"/122 cm	2691922	SZT275	-
SY1758100YP	Correa tracción			SZT105	-
SY84001701	Correa cuchillas			SZT105	-
SY885714YP	Correa tracción			SZT350	-
SY1757901YP	Correa cuchillas			SZT350	-

**CUCHILLAS TRACTORES CORTACÉSPED SIMPLICITY**



SY1758511BMYP	(1) Cuchilla RH	96 cm	2691263	SRD100/210	-
SY1758512BMYP	(2) Cuchilla LH	96 cm	2691263	SRD100/210	-
SY1758513BMYP	(3) Cuchilla RH	107 cm	2691265	SRD300/360	-
SY1758514BMYP	(4) Cuchilla LH	107 cm	2691265	SRD300/360	-
SY1752100AYP	(5) Cuchilla	42"/107 cm	2691218	SLT100/110	-
SY1737252BZYP	(6) Cuchilla	46"/118 cm	2691262	SLT200	-
SY1752100AYP	Cuchilla descarga lateral	42"/107 cm	2691923	SZT175	-
SY1760645YP	Cuchilla descarga trasera	42"/107 cm	2691923	SZT175	-
SY1759055YP	Cuchilla descarga lateral	48"/122 cm	2691922	SZT275	-
SY1760647YP	Cuchilla descarga trasera	48"/122 cm	2691922	SZT275	-
SY84001711	Cuchilla lateral			SZT105	-
SY84001712	Cuchilla trasera			SZT105	-
SY1756152AYP	Cuchilla lateral			SZT350	-
SY17606484YP	Cuchilla triturar			SZT350	-

(RH: derecha  
LH: izquierda)



**ACCESORIOS SIMPLICITY**

	REFERENCIA	DESCRIPCIÓN	MODELOS	P.V.P SIN I.V.A.
1	 SY1696352YP	(1) Contrapeso rueda trasera	SRD310/SRD360	-
1A	 SY1695092SM	(1A) Cadena rueda 22"x9,5"-12	SRD310/SRD360	-
1B	 SY1696092	(1B) Cuchilla para nieve	SRD310/SRD360	-
2	 SY1697428	(2) Kit Mulching 36"	SZT105	-
3	 SY1696907	(3) Kit Mulching 48"	SZT275-2691460	-
4	 SY1696374YP	(4) Kit mulching 42" Tractores descarga lateral	Cavalier - SRE300 - 2691354 EZT2042F - 2691048 SLT100 - 2691218	-
5	 SY1696910	(5) Kit mulching eliminator	SLT100 - 2691218 SLT200 - 2691262 ELT2246 - 2690840 SZT150-2691357	-
6	 1695947YP	(6) Kit mulching 52"	EZT2752F-590947 SZT300 - 591268	-
7	 SY1696693YP	(7) Kit mulching 48" Giro Zero	ZTX250	-
	 SY1696909	Kit mulching eliminator		-
8	 SY1696908	(8) Kit mulching eliminator 52"	STZ350-2691411	-

**ACCESORIOS SIMPLICITY**

	REFERENCIA	DESCRIPCIÓN	MODELOS	P.V.P SIN I.V.A.
	<b>SY885644YP</b>	Tapón mulching 96 cm Tractores descarga trasera	SRD100	-
	<b>SY885959YP</b>	Tapón Mulching 107 cm Tractores descarga trasera	Regent XL RD 42" 2691105-2691106-2691265 SRD310-2691486 SRD360 - 2691509	-
	<b>SY1687400</b>	Tapón mulching	Regent RD 2690849 - 2690850 - 2690853	-
	<b>SY885654YP</b>	Deflector trasero	ELT17538RDF ELT2242RDF LT2642RDF	-
			SRD100 SRD300	
	<b>SY1688033</b>	Deflector trasero	SRD210/310/360	-
	<b>SY885862YP</b>	Enganche remolque	ELT17538RDF - 1696113 2691122 - 2691121 ELT2242RDF - 2691105 LT2642RDF - 2691106	-
	<b>SY1696711</b>	Maleta de carga	SZT150 SZT350 / SZT275	-
	<b>SY1731270AYP</b> <b>SY1687939</b>	Defensa	SRD300 / SRD100 SZT 275	-
	<b>SY5601306</b>	Soporte elevador - tractor SZT	Simplicity SZT	-
	<b>SY5601305</b>	Elevador tractor Simplicity SZT	Simplicity SZT	-

Gama máquinas



**CAMON**  
OUTDOOR POWER EQUIPMENT

Gama máquinas

## VAREADORES DE PEINE MOTOR ELÉCTRICO



Naomi

REFERENCIA	POTENCIA	PESO	LONGITUD DE TUBO	P.V.P SIN I.V.A.
<b>TWIST 2.0 PLUS</b>	270W	2,5 kg	2,5 m	426,12
<b>NAOMI</b>	700W	2,3 kg	2,5 m	639,18

## CABEZAL VAREADOR PEINE



<b>ZEUS</b>	Adaptable a distintos diámetros de tubo y de transmisión	309,91
-------------	--	--------

## ADAPTADORES

REFERENCIA	DESCRIPCIÓN / MEDIDA	PERFIL / FORMA	P.V.P SIN I.V.A.
<b>ADAPTADORES EJE DE TRANSMISIÓN ZEUS</b>			
3483.001	Adaptador transmisión 7 estrías		11,95
3483.002	Adaptador transmisión 9 estrías		11,95
3483.003	Adaptador transmisión 10 estrías		11,95
3483.004	Adaptador transmisión cuadrado 5,4 mm		11,95
3483.005	Adaptador transmisión cuadrado 6,0 mm		11,95
3483.006	Adaptador transmisión oval 5.5 mm		11,95
3483.007	Adaptador transmisión oval 6.5 mm		11,95
<b>CASQUILLOS ADAPTADORES PARA TUBOS DE TRANSMISIÓN ZEUS</b>			
3842.001	30/26		3,95
3842.002	30/25		3,95
3842.003	30/25,4		3,95
3842.004	30/24		3,95
3842.005	30/28		3,95
3842.006	30/27		3,95

**MOTOSIERRAS ELÉCTRICAS**

REFERENCIA	CILINDRADA POTENCIA	PESO*	LONGITUD BARRA	P.V.P SIN I.V.A.
GT9302 881860	2000W	3,2	16"-40 cm	129,23

**MOTOSIERRAS DE GASOLINA**

REFERENCIA	CILINDRADA POTENCIA	PESO*	LONGITUD BARRA	P.V.P SIN I.V.A.
XCS2500TC	25,0 cc	2,4 kg	10" - 25 cm	184,29
TCS2600	25,9 cc	2,9 kg	10" - 25 cm	167,14
TCS2600 PRO	25,9 cc	2,9 kg	10" - 25 cm	184,29
XCS2500C	25,0 cc	2,7 kg	12" - 30 cm	192,86
XCS4200	40 cc	4,7 kg	16" - 40 cm	178,57
XCS4600	45 cc	5,0 kg	18" - 45 cm	197,14
XCS5000	50 cc	5,1 kg	18" - 45 cm	205,71

## BARRAS MOTOSIERRAS CAMON - OREGON

NOVEDAD



REFERENCIA	CILINDRADA POTENCIA	PESO*	LONGITUD BARRA	P.V.P SIN I.V.A.
XCS5600	56 cc	5,2 kg	18" - 45 cm	212,86
TCS6200	62 cc	5,8 kg	20" - 50 cm	348,57

## BARRAS MOTOSIERRAS CAMON - OREGON



REFERENCIA	TAMAÑO / PASO	Nº GUÍAS	MODELO	P.V.P SIN I.V.A.
TDH1002543	Barra 10" 1/4" Micro	56E	XCS2500TC	20,95
TDH1202543	Barra 12" 1/4" Micro	64E	XCS2500C	21,95
AT10-50	Barra carving 10" 1/4"	60DL	C26 Pro / TCS2600 PRO	30,95
537599	Barra Oregon 10" 3/8 LP 1,3mm	40DL	C26/TCS2600	19,95
523653	Barra Oregon 16" 3/8 LP 1,3mm	57DL	C37 / C41/TCS4100 YT4302 / YT4632 MVC3501S/GY9303	27,95
523700	Barra Oregon 18" 325 1,5 mm	72DL	C45 / C50 / TCS4600 TCS5000 / MCV5100S	39,75
200SLHD176	Barra Oregon 20" 3/8 1,3 mm	72DL	C62/TCS6200	39,75
168SLGK095	Barra Oregon 16" 325 1,5 mm	66DL	HUSQVARNA / JONSERED DOLMAR / OLEO MAC	37,00

## FUNDAS DE BARRA



REFERENCIA	TAMAÑO	P.V.P SIN I.V.A.
G007	Funda barra 10" - 25cm	3,10
G008	Funda barra 12" - 30cm	3,75
G009	Funda barra 14" - 35cm	3,75
G010	Funda barra 16" - 40cm	3,75
G011	Funda barra 18" - 45cm	3,90
G012	Funda barra 20" - 50cm	4,15

## CADENAS CORTADAS OREGON



REFERENCIA	TAMAÑO / PASO	Nº GUÍAS	MODELO	P.V.P SIN I.V.A.
T23P056X	Cadena 1/4" Micro	56E	XCS2500TC	17,75
T23P064X	Cadena 1/4" Micro	64E	XCS2500C	18,75
ML247947	Cadena 1/4 1,1 mm	60DL	MCV3101TS-Q	33,95
SH2320026676	Cadena Oregon 3/8LP 1,3 mm	39DL	GJD330/QJB270	15,95
91PJ040X	Cadena Oregon 3/8LP 1,3 mm	40DL	C26 / MCV3100TS	14,95
91PX045E	Cadena Oregon 3/8LP 1,3 mm	45DL	MCV3900	16,95
91VXL052E	Cadena Oregon 3/8LP 1,3 mm	52DL	MCV4000	19,95
91VXL050E	Cadena Oregon 3/8LP 1,3 mm	50DL	MCV4000	18,95
91PX057E	Cadena Oregon 3/8LP 1,3 mm	57DL	C37/C41/C1600E /TCS4100 YT4302/YT4632	20,95
20BPX072E	Cadena Oregon 325 1,3 mm	72DL		25,95
21LPX072X	Cadena Oregon 325 1,5 mm	72DL	C45/C50/TCS4600/TCS5000	26,95
21BPX072X	Cadena Oregon 325 1,5 mm	72DL	C45/C50/TCS4600/TCS5000 MCV5600/ MCV5100S	26,95
73LPX068E	Cadena Oregon 3/8 1,5 mm	68DL		27,95
72LGX072X	Cadena Oregon 3/8 1,3 mm	72DL	C62	28,95
73LPX070X	Cadena Oregon 3/8 1,5 mm	70DL	C62	27,95

## TAPAS DE CADENA CPL MOTOSIERRAS CAMON

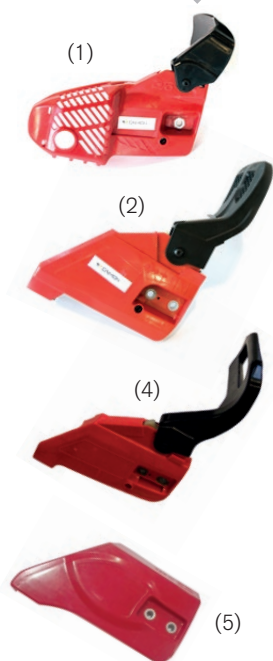

REFERENCIA	DESCRIPCIÓN	MODELO	P.V.P SIN I.V.A.
TCS2600-069	1. Tapa cadena completa	C26 / C26 PRO / TCS2600	20,95
TCS4100A-01	2. Tapa cadena completa	TCS4100	23,75
TCS4600A-01	2. Tapa cadena completa	TCS4600 / TCS5000	26,90
C37-ZJB037A	Tapa cadena CPL	C37 / C41	21,90
C45-ZJA001	Tapa cadena CPL	C45	26,90
C50-A001	4. Tapa cadena CPL	C50	26,90
C62-B067	5. Tapa cadena (sola)	C62	12,93
TCS6200-65	5. Tapa cadena (sola)	TCS6200	6,95
A25.2312.0200	Tapa cadena	XCS2500C/TC	9,95

## TENSORES CADENA MOTOSIERRAS CAMON

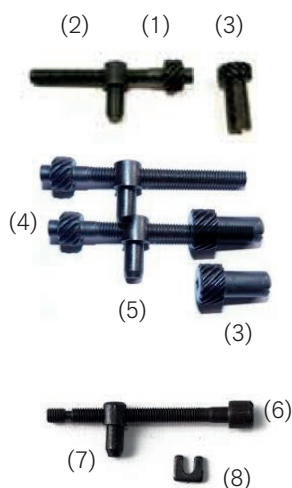

REFERENCIA	DESCRIPCIÓN	MODELO	P.V.P SIN I.V.A.
C26-142	1. Tornillo tensor	C26 / C26 Pro / TCS2600	1,50
C26-143	2. Pivote tensor	C26 / C26 Pro / TCS2600	1,50
C45-ZJA029	3. Piñon Tensor	C26 / C26 Pro / TCS2600	1,80
C45-ZJA012	4. Tornillo tensor	TCS4100 / TCS4600 / TCS5000 / C45 / C50	1,60
C45-ZJA013	5. Pivote tensor	TCS4100 / TCS4600 / TCS5000 / C45 / C50	1,60
C45-ZJA029	3. Piñon tensor	TCS4100 / TCS4600 / TCS5000 / C45 / C50	1,60
C50-A007	6. Tornillo tensor frontal	-	1,30
C-50-A006	7. Pivote tensor frontal	-	1,50
C45-ZJA075	8. Clip tensor frontal	-	0,59
C62-A051	Pivote tensor	C62 / TCS6200	1,50
C62-A053	Tornillo tensor	C62 / TCS6200	1,90
A27.0112.0008	Tornillo tensor	XCS2500C/TC	1,75

## CHAPAS ENGRASE MOTOSIERRAS CAMON

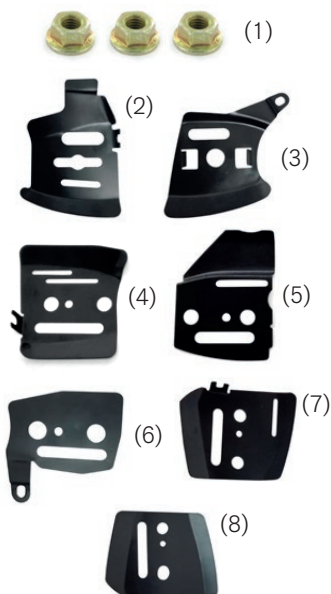

REFERENCIA	DESCRIPCIÓN	MODELO	P.V.P SIN I.V.A.
C37-ZJB059	(1) Tuerca barra M8	C26/C37/C41/C45/C50/C37/C41/C45/C50 C62/TCS2600/TCS4100/TCS4600/TCS5000	0,89
C26-106	(2) Chapa engrase interior	C26/C26PRO/TCS2600	2,90
C26-141	(3) Chapa engrase exterior	C26/C26PRO/TCS2600	2,90
C37-ZJA026	(4) Chapa engrase interior	C37/C41/TCS4100	2,90
C45-ZJB099	(5) Chapa engrase interior	C45/C50/TCS4600/TCS5000	2,90
C45-ZJA020	(6) Chapa engrase exterior	C41/C45/C50/TCS4600/TCS5000	2,90
C62-B063	(7) Chapa engrase interior	C62 / TCS2600	3,10
C62-B066	(8) Chapa engrase exterior	C62 / TCS2600	3,10
A25.2100.0022	Chapa engrase	XCS2500C/TC	3,59

## EMBRAGUES CPL MOTOSIERRAS Y DESBROZADORASCAMON

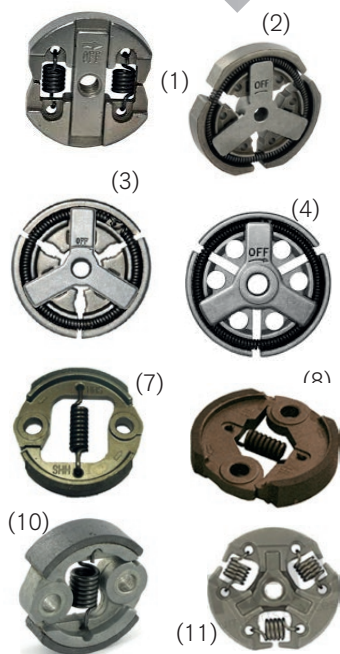

REFERENCIA	DESCRIPCIÓN	MODELO	P.V.P SIN I.V.A.
C26-084	1. Embrague CPL Camon	C26 / C26 Pro / TCS2600	13,90
C37-ZJA051	2. Embrague CPL Camon	C37 / C41 / TCS4100	14,90
C45-ZJB100	3. Embrague CPL Camon	C45 / C50 / TCS4600 / TCS5000	15,90
C62-A100	4. Embrague CPL Camon	C62 / TCS6200	17,90
SH2320009866	Zapata embrague	CG260E	3,10
SH2320008791	Muelle embrague	CG260E	0,95
SH2320056058	7. Embrague CPL	CG330E / CG430E / BG520A 3GC430 / 3GC520	10,90
SH2320013769	8. Embrague CPL	BG431 / BG520A	10,90
SH2320028237	9. Embrague CPL	CG260 / QJB270 / 3WZ+6F	8,90
ZJA061	10. Embrague CPL	GJB25D	10,95
A25.2101.9999	11. Embrague CPL	XCS2500C/TC	16,75

## MUELLES DE EMBRAGUE MOTOSIERRAS Y DESBROZADORAS CAMON



REFERENCIA	DESCRIPCIÓN	MODELO	P.V.P SIN I.V.A.
C26-086	1. Muelle embrague Camon	C26/C26Pro/TCS2600	1,95
C37-ZJA054	2. Muelle embrague Camon	C37/C41/C45/C50/TCS4100/TCS4600/TCS5000	1,95
C62-A089	3. Muelle embrague Camon	C62/TCS6200	1,95
SH2320008791	Muelle embrague 31 mm	QJB270 / CG260E / 3WZ-6F	1,10
A25.2101.0014	5. Muelle embrague	XCS2500C/TC	1,75

## CAMPANAS DE EMBRAGUE MOTOSIERRAS CAMON

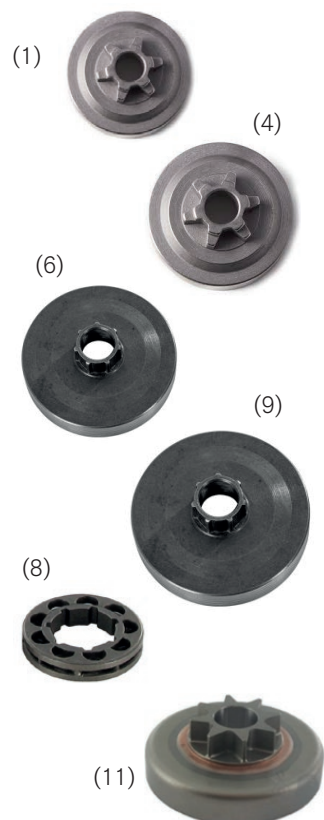

REFERENCIA	DESCRIPCIÓN	MODELO	P.V.P SIN I.V.A.
C26-083	1. Campana 3/8BP 6T 13x54x57	C26/TCS2600	10,75
C26-083 1/4	Campana 1/4 8T	C26 Pro	13,90
C26-089	Cojinete 10X13X13	C26 / C26 Pro / TCS2600	3,95
C37-ZJA049	4. Campana 3/8 BP 13x68x71	C37 / C41 / TCS4100	11,90
C37-ZJA050	Cojinete 10x13x13	C37 / C41 / TCS4100	3,95
C45-ZJB049	6. Campana (sin corona) 15x68x70	C45 / C50 / TCS4600 / TCS5000	11,95
C45-ZJB048	Cojinete 12x15x14,5	C45 / C50 / TCS4600 / TCS5000	3,95
CASRK27	8. Corona 325x7	C45 / C50 / TCS4600 / TCS5000	2,50
C62-A092	9. Campana (sin corona) 14x77x81	C62 / TCS6200	14,90
C62-A091	Cojinete 10x14x12,5	C62 / TCS6200	3,95
A25.2101.0009	Campana 3/8LP	XCS2500C/TC	13,95
A25.2101.0010	Campana 1/4" MINI	XCS2500C/TC	12,95



## BOBINAS Y ELECTRÓNICOS MOTOSIERRAS CAMON

REFERENCIA	DESCRIPCIÓN	MODELO	P.V.P SIN I.V.A.
C26-033	1. Bobina	Camon: C26/C26 PRO/TCS2600	20,75
C37-ZJA065	2. Bobina	Camon: C37/C41/TCS4100	21,75
C45-ZJB095	3. Bobina	Camon: C45/C50/TCS4600/TCS5000	22,75
C62-A029	4. Electrónico	Camon: C62 / TCS6200	14,95
C62-A028	5. Bobina	Camon: C62 / TCS6200	19,95
SH2320069082	6. Electrónico	CG260E	29,75
SH2320027088	7. Electrónico	CG330E	29,75
SH2320037468	8. Electrónico	CG430E	29,75
SH2320099084	9. Electrónico	3GC430 / 3GC520	27,90
SH2320006439	Electrónico	BG431	29,75
SH2320034496	Electrónico	EBV260	29,75
SH2320073261	Electrónico	QJB270	29,90
SH2320067802	13. Electrónico	BG520A	22,95
A25.2106.0200	14. Electrónico	XCS2500C/TC	24,35

## CARBURADORES MOTOSIERRAS Y DESBROZADORAS CAMON

REFERENCIA	DESCRIPCIÓN	MODELO	P.V.P SIN I.V.A.
C26-094	1. Carburador WT905A	Camon: C26/C26PRO/TCS2600	45,90
C37-ZJB082	2. Carburador WT840A	Camon: C37/C41/TCS4100	46,90
C50-B064	3. Carburador WT893A	Camon: C45/C50/TCS4600/TCS5000	47,90
C62-A014	4. Carburador HDA 238A	Camon: C62 / TCS6200	79,75
SH2320113743	5. Carburador	3GC230A 3CS230EF / CG260E / CG330E / GJD330	26,90
SH2320115116	6. Carburador	3WT300 / CG430E / BG520A 3GC430 / 3GC520	26,95
SH2320034321	7. Carburador	BG431	27,90
SH2320026450	Carburador	EBV260E	29,95
SH2320037863	Carburador	QJB270	29,95
SH2320036565	Carburador	3WZ6F	29,95
ZJA053	Carburador	GJB25D	25,95
SH2320065695	15. Carburador	EB800E	34,46
A25.2101.0500	14. Carburador	XCS2500TC	57,95



**TAPAS PUESTA EN MARCHA MOTOSIERRAS, DESBROZADORAS Y SOPLADORES CAMON**

	REFERENCIA	DESCRIPCIÓN	MODELO	P.V.P SIN I.V.A.
	<b>TCS2600-140</b>	1. Tapa P/M CPL Camon	TCS2600	21,90
	<b>TCS4100 A-37</b>	2. Tapa P/M CPL Camon	TCS4100	24,95
	<b>TCS4600 A-36</b>	3. Tapa P/M CPL Camon	TCS4600/TCS5000	22,90
	<b>C26-108</b>	Tapa P/M CPL Camon	C26 - C26 Pro	19,95
	<b>C37-ZJB061</b>	5. Tapa P/M CPL Camon	C37	18,90
	<b>C41-ZJA038</b>	6. Tapa P/M CPL Camon	C41	19,95
	<b>C45-ZJA037</b>	Tapa P/M CPL Camon	C45	19,95
	<b>C50-A034</b>	8. Tapa P/M CPL Camon	C50	19,95
	<b>C62-B077</b>	9. Tapa P/M CPL Camon	C62	22,95
	<b>SH2320007383</b>	10. Tapa P/M CPL	BG431	21,90
	<b>SH2320054458</b>	11. Tapa P/M CPL	CG330 / CG430 / GJD330 QGZ25-30	14,95
	<b>SH2320032329</b>	12. Tapa P/M CPL	CG260 / EBV260	18,95
	<b>SH2320042961</b>	13. Tapa P/M CPL	BG520A	15,90
	<b>SH2320033600</b>	14. Tapa P/M CPL	QJB270	15,90
	<b>SH2320104018</b>	15. Tapa P/M CPL	3GC430 / 3GC520	18,95
	<b>SH2320050090</b>	16. Tapa P/M CPL	EB800E	16,90
	<b>SH2320109655</b>	17. Tapa P/M CPL	Q33 / Q43 / Q52	16,95
	<b>ZJC056</b>	18. Tapa P/M CPL	GJB25D	14,95
	<b>A25.2310.0002</b>	19. Tapa P/M (sola)	XCS250C/TC	8,95
	<b>SH2320072472</b>	20. Tapa P/M CPL	3WZG6F	18,75

## POLEAS PUESTA EN MARCHA MOTOSIERRAS CAMON

	REFERENCIA	DESCRIPCIÓN	MODELO	P.V.P SIN I.V.A.
(1)  (2) 	<b>C26-110</b>	1. Polea P/M	Camon: C26/C26 PRO/TCS2600	3,50
	<b>C37-ZJB062</b>	2. Polea P/M	Camon: C37/C41/TCS4100	3,50
(3)  (4) 	<b>C45-ZJA041</b>	3. Polea P/M	Camon: C45/C50/TCS4600/TCS5000	4,50
	<b>C62-B019</b>	4. Polea P/M	Camon: C62 / TCS6200	4,50
(5)  (7) 	<b>SH2320026204</b>	Polea P/M	Camon: SG250	4,95
	<b>SH2320007365</b>	Polea P/M	Camon: CG260E/EBV260E/3WZ-6F	4,95
	<b>SH2320007367</b>	5. Polea P/M	Camon: CG330-E / CG430-E	4,95
	<b>ZJC047</b>	Polea P/M	GJB25D	4,50
	<b>A25.2110.0002</b>	7. Polea trinquetes	XCS2500C/TC	4,95
	<b>A25.2110.0003</b>	Polea P/M	XCS2500C/TC	4,95

## MUELLES PUESTA EN MARCHA CAMON

	REFERENCIA	DESCRIPCIÓN	MODELO	P.V.P SIN I.V.A.
	<b>C26-111</b>	Muelle P/M	Camon: C26/C26 Pro/TCS2600	4,15
	<b>C50-A040</b>	Muelle P/M	Camon: C37/C41/C45/C50/TCS4100 TCS4600/TCS5000	3,90
	<b>C62-B016</b>	Muelle P/M	Camon: C62 / TCS6200	3,90
	<b>ZJC046</b>	Muelle P/M	Camon: GJB 25D	4,15
	<b>SH2320007379</b>	Muelle P/M	CG260 / EBV260E	4,95
	<b>SH2320018251</b>	Muelle P/M	CG330E / CG430E / GJD330	4,95
	<b>A25.0110.0004</b>	Muelle arranque facil	XCS2500C/TC	3,59

## BOMBAS DE ACEITE Y SINFINES MOTOSIERRAS CAMON

(1)  (2) 	<b>C37-ZJA057</b>	1. Bomba de aceite Camon	C26/C26 Pro/C37/C41 TCS2600/TCS4100	11,90
	<b>C45-ZJB039</b>	2. Bomba de aceite Camon	C45 / C50 / TCS4600 / TCS5000	13,90
	<b>C62-A085</b>	3. Bomba de aceite Camon	C62 / TCS6200	13,90
(3) 	<b>C37-ZJA058</b>	4. Sinfín engrase Camon	C26/C37/C41/TCS2600/TCS4100	3,10
	<b>C45-ZJB051</b>	5. Sinfín engrase Camon	C45/C50/TCS4600/TCS5000	3,10
(4)  (5)  (6) 	<b>C62-A083</b>	6. Sinfín engrase Camon	C62 / TCS6200	3,10
(7)  (8) 	<b>SH2320060389</b>	7. Bomba de aceite	GJD330 / QJB270	18,95
	<b>A25.2114.0100</b>	8. Bomba de aceite	XCS2500C/TC	13,95
(9) 	<b>A25.2101.0200</b>	9. Sinfín engrase	XCS2500C/TC	3,55

**CILINDROS Y PISTONES MOTOSIERRAS CAMON**

A25.2101.0008	Cilindro	XCS2500C/TC	34,89
A25.2101.0007	Junta Cilindro		1,95
A25.2103.0200	Pistón		11,52
A27.0103.0002	Aro Pistón		4,48
A27.0103.0001	Bulón Pistón		1,95
C26-001	Cilindro	C26 C26 Pro TCS2600	28,31
C26-008	Pistón ø 34 mm (1 ARO)		10,00
C26-009	Segmento Pistón		3,90
C26-010	Bulón Pistón 17x8		1,95
C26-011	Clip Bulón Pistón		0,60
C26-012	Rodamiento Biela-Pistón 8x11x9		3,95
TCS5600A-01	Cilindro	TCS5600	37,75
C45-ZJB016	Junta cilindro		1,76
TCS5600A-16	Pistón ø 46 mm (2 AROS)		15,00
TCS5600A-15	Segmento Pistón		3,90
TCS5600A-18	Bulón Pistón		1,95
C45-ZJB019	Clip Bulón Pistón		0,68
C45-ZJB23	Rodamiento Biela-Pistón 11x15x12,5	3,95	
G1544	Cilindro + Pistón CPL	C41 TCS4100	29,95
C37-ZJA005	Junta cilindro		1,35
C41-ZJB017	Pistón 40,5 mm (1 aro)		17,00
C41-ZJB014	Segmento Pistón		3,90
C37-ZJA030	Bulón Pistón 17,5x10		1,95
C37-ZJA031	Clip Bulón Pistón		0,39
C37-ZJA032	Rodamiento Biela-Pistón 10x14x11	3,95	
C45-ZJB001	Cilindro	C45 TCS4600 XCS4600	33,71
C45-ZJB016	Junta cilindro		1,76
C45-ZJB018	Pistón ø 43 mm (2 aros)		16,00
C45-ZJB017	Segmento Pistón		3,90
C45-ZJB020	Bulón Pistón 34x11		1,95
C45-ZJB019	Clip Bulón Pistón		0,68
C45-ZJB023	Rodamiento Biela-Pistón 11x15x12,5	3,95	
C50-B001	Cilindro	C50 TCS5000	37,15
C45-ZJB016	Junta cilindro		1,76
C50-B018	Pistón ø 45 mm (2 aros)		17,00
C50-B017	Segmento Pistón		3,90
C50-B020	Bulón Pistón 37x11		2,11
C45-ZJB019	Clip Bulón Pistón		0,69
C45-ZJB023	Rodamiento Biela-Pistón 11x15x12,5	3,95	
C62-A009	Cilindro	C62 TCS6200	42,17
C62-A036	Junta cilindro		1,76
C62-A038	Pistón ø 47 mm (2 aros)		17,26
C62-A037	Segmento Pistón		3,90
C62-A039	Bulón Pistón 40x11		2,14
C45-ZJB019	Clip Bulón Pistón		0,69
C45-ZJB023	Rodamiento Biela-Pistón 11x15x12,5	3,95	
ZJA045	Cilindro	GJB-25D	21,00
ZJA039	Junta cilindro		1,10
ZJA060	Pistón CPL (2 Aros)		12,00
A42.5101.0003	Cilindro	XCS4200	29,75
A42.5101.0004	Junta cilindro		1,95
A42.5103.0101	Pistón 42mm		17
A41.1103.0001	Aro pistón		2,75
A42.5103.0102	Bulón pistón		1,9
C37-ZJA031	Clip bulón pistón	0,69	
C37-ZJA032	Cojinete pistón	3,95	
A50.0101.0002	Cilindro	XCS5000	37,15
C45-ZJB016	Junta cilindro		1,95
A50.0103.0200	Pistón ø 45 mm		17
C50-B017	Aro Pistón		3,9
A50.0103.0003	Bulón Pistón		1,95
C45-ZJB019	Clip Bulón Pistón		0,69
C45-ZJB023	Cojinete pistón	3,95	
TCS5600A-01	Cilindro	XCS5600 TCS5600	39,75
C45-ZJB016	Junta cilindro		1,95
TCS5600A-16	Pistón ø 47 mm		17,75
TCS5600A-15	Aro Pistón		3,9
TCS5600A-18	Bulón Pistón		1,95
C45-ZJB019	Clip Bulón Pistón		0,69
C45-ZJB023	Cojinete pistón	3,95	

## CILINDROS Y PISTONES DESBROZADORAS Y SOPLADORES CAMON



SH10301822	Cilindro	EBV260 CG260E	25,00
SH2320016879	Junta cilindro		1,95
SH2320016872	Pistón ø 34 mm		12,00
SH2320048520	Aro pistón		3,96
SH2320008654	Bulón Pistón		1,68
SH2320007024	Clip bulón - pistón		0,39
SH23200028962	Cojinete pistón		3,94
SH10301795	Cilindro	CG330E GJB330 CG415Q33	26,00
SH2320016550	Junta cilindro		2,45
SH2320051666	Pistón ø 36 mm		10,75
SH2320048523	Aro pistón		3,97
SH2320008655	Bulón Pistón		1,90
SH2320007025	Clip bulón - pistón		0,39
SH2310001927	Cojinete pistón		3,96
SH10301805	Cilindro	CG430E CG415Q43	29,00
SH2320016853	Junta cilindro		2,56
SH2320050831	Pistón ø 40 mm		8,75
SH2320048282	Aro pistón		3,96
SH2320008661	Bulón Pistón		1,90
SH2320027110	Clip bulón - pistón		0,39
SH2320029199	Cojinete pistón 10x14x15,5		3,96
SH10303736	Cilindro	3GC520 BG520A EB-500-E	29,75
SH2320008470	Junta cilindro		2,56
SH2320050846	Pistón ø 44 mm		16,00
SH2320007010	Aro pistón		3,96
SH2320096800	Bulón Pistón		1,90
SH2320027110	Clip bulón - pistón		0,39
SH2320029199	Cojinete pistón		3,96
SH10302491	Cilindro	EB800E	36,00
SH2320059860	Junta cilindro		2,30
SH2320050088	Pistón ø 53 mm		12,90
SH2320007014	Aro pistón		3,96
SH10200645	Bulón Pistón		3,25
SH2320007029	Clip bulón - pistón		0,59
SH2320047877	Cojinete pistón		3,95

## CILINDROS Y PISTONES PODADORA, PULVERIZADOR, MOCHILA Y CORTASETOS CAMON



SH10303001	Cilindro	QJB270	29,32
SH2320047228	Junta cilindro		1,95
SH2320050952	Pistón ø 34 mm		19,48
SH2320010990	Aro pistón		3,96
SH2320014632	Bulón Pistón		1,95
SH2320007023	Clip bulón - pistón		0,49
SH2320028962	Cojinete pistón		3,94
SH10300698	Cilindro	3WZ-6F	26,87
SH2320008499	Junta cilindro		2,19
SH2320015718	Pistón ø 34 mm		12,66
SH2320010990	Aro pistón		3,96
SH10200114	Bulón Pistón		1,90
SH2320007024	Clip bulón - pistón		0,39
SH2320028962	Cojinete pistón		3,94
SH2320009550	Cilindro	BG431	19,00
SH2320006963	Pistón ø 39 mm		11,75
SH2320006597	Aro pistón		2,90
SH2320019763	Aro pistón		2,90
SH2320075909	Bulón Pistón		1,30
SH2320006593	Clip bulón - pistón		2,95
SH2320007023	Cojinete pistón 10x14x15,5		0,49
ZJA045	Cilindro	GJB-25D	23,60
ZJA039	Junta cilindro		1,10
ZJA060	Pistón CPL		12,00
ZJA034	Cojinete 8x11x9		2,89

## CILINDROS Y PISTONES DESBROZADORAS CAMON 3GC



SH10303737	Cilindro	3GC430	16,90
SH2320050467	Junta cilindro		2,56
SH2320050831	Pistón ø 40 mm		8,75
SH2320048282	Aro pistón		3,96
SH2320008661	Bulón pistón		1,90
SH2320027110	Clip bulón - pistón		0,39
SH2320029199	Cojinete pistón 10x14x15,5		3,96
SH10303736	Cilindro	3GC520	27,75
SH2320050846	Pistón ø 44 mm (2 Aros)		16,00
SH2320050467	Junta cilindro		2,56
SH2320007010	Aro pistón		3,96
SH2320008658	Bulón pistón		1,90
SH2320027110	Clip bulón - pistón		0,39
SH2320029199	Cojinete pistón		3,96

## CORTASETOS ELÉCTRICOS



REFERENCIA	POTENCIA	DESCRIPCIÓN	PESO	P.V.P SIN I.V.A.
CYHT02A 880120	710 W	Longitud de corte 60 cm Separación entre cuchillas 24 mm Asa trasera giratoria 180°	3,8 kg	129,23

## CORTASETOS DE GASOLINA



GJB-25D	25 cc	Longitud de corte 60 cm Asa trasera giratoria 180° Sistema antivibraciones Separación entre cuchillas 25 mm	4,5 kg	175,71
---------	-------	--	--------	--------

## CORTACÉSPEDES ELÉCTRICOS

REFERENCIA	CORTE	RECOGEDOR	PESO	CARCASA	MOTOR	P.V.P SIN I.V.A.
 <b>ZA330</b>	Ancho 33 cm Alturas 3 20/40/60 350 m <sup>2</sup>	30 litros	12,8Kg.	ABS	1.200 W	88,29
 <b>ZA380</b>	Ancho 38 cm Alturas 5 20/70 500 m <sup>2</sup>	40 litros	15,4 Kg.	ABS	1.600 W	133,77
 <b>GT46E</b>	Ancho 46 cm Alturas 5 20-55 800 m <sup>2</sup>	45 litros	21 kg	Acero	1.800 W	429,53

## CORTACÉSPEDES DE GASOLINA SIN TRACCIÓN

REFERENCIA	CORTE	RECOGEDOR	PESO	REF. ELECTROLUX	MOTOR	P.V.P SIN I.V.A.
 <b>G42AP-1</b>	Ancho 42cm Alturas 6 25-75 600 m <sup>2</sup>	45 litros	23 Kg.	Acero	79,8cc	215,48

**CORTACÉSPEDES DE GASOLINA CON TRACCIÓN**

	REFERENCIA	CORTE	RECOGEDOR	PESO	REF. ELECTROLUX	MOTOR	P.V.P SIN I.V.A.
	<b>G46SHL-B1</b>	Ancho 46 cm Alturas 6/ 25-75 1200 m <sup>2</sup>	65 litros	30 Kg.	Acero	145cc	350,47
	<b>G51SHL-C1</b>	Ancho 51 cm Alturas 6/ 25-75 1800 m <sup>2</sup>	65 litros	35Kg.	Acero	170cc	379,90
	<b>G51SHL GCV170</b>	Ancho 51 cm Alturas 6/ 25-75 1800 m <sup>2</sup>	65 litros	35Kg.	Acero	Honda GCVx170	593,93
	<b>HR 57 SH 3V</b>	Ancho 57 cm Alturas 5 20-65 3000 m <sup>2</sup>	70 litros	41 Kg	Acero	Honda GCVx200	1.115,85
	<b>MX 57 SH 3V</b>	Ancho 57 cm Alturas 5 20-65 3000 m <sup>2</sup>	70 litros	41 Kg	Inox.	Honda GCVx200	1.359,75



## CUCHILLAS CORTACÉSPED CAMON - BLUEBIRD

REFERENCIA	DESCRIPCIÓN	A	B	C	D	MODELOS	P.V.P SIN I.V.A.
AI70130380000	Cuchilla	420	Ovalado			B42	27,95
AI70131080000	Cuchilla	460	Ovalado			B46T	28,95
AI70130360000	Cuchilla	510	Ovalado			B51T	29,95
AI70131340000	Cuchilla	510	Ovalado			H51T	29,95



## CUCHILLAS CORTACÉSPED CAMON - DAYE

REFERENCIA	DESCRIPCIÓN	A	B	C	D	MODELOS	P.V.P SIN I.V.A.
2105200111A	(1) Cuchilla	380	20	-	-	DYM1115EB	15,95
2105200132B	(2) Cuchilla	410	8	-	-	DYM1180	16,95
2105200030F	(3) Cuchilla	390	16	-	-	DYM1661FB	13,90
2105200263	Cuchilla	460	19	-	-	DYM1626CQ	27,90
2105200262	(5) Cuchilla	510	19	-	-	DYM1560CQN	26,95
2105200084A	(8) Cuchilla	510	12	-	-	DYM1588EN DYM1720C	29,95
21051000253200A	(9) Soporte Cuchilla	H. 25 mm 12,5x16,3 mm Inter. 74,8mm				DYM1115EB DYM1180	4,15
2105200251A	(10) Soporte Cuchilla	-	-	-	-	DYM1626 DYM1560 DYM1661	8,90
2105300020B	(11) Soporte Cuchilla	H. 38 mm ø25 mm Inter. 61,6mm				DYM1720C	19,90
2105300028B	(12) Soporte Cuchilla	H. 48,3 mm ø22,2 mm Inter. 61,6mm				DYM1588EN	13,90

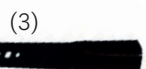
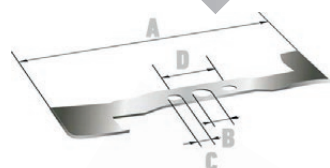



**SACOS TELA Y SOPORTE METÁLICO CORTACÉSPED CAMON - DAYE**

REFERENCIA	DESCRIPCIÓN	MODELOS	P.V.P SIN I.V.A.
AI20070070014	Cesto recogedor inferior	B42	39,75
AI20070100000	Cesto recogedor inferior	B46T	39,75
AI20050080009	Cesto recogedor inferior	B51T/H51T	46,95
21077000752188A	Saco recogedor	DYM1115EB	13,95
21077000832188A	Saco recogedor	DYM1180	14,95
21077000572188B	Saco recogedor	DYM1661FB	16,95
G22150A1000	Saco recogedor	G46SHL / G51SHL	29,88
2107200054A	Soporte metálico	DYM1115EB	12,95
2107200061A	Soporte metálico	DYM1180	12,95
2107200032A	Soporte metálico	DYM1661FB	17,90
2107200041A	Soporte metálico	DYM1626CQ	19,95
2107200071A	Soporte metálico	DYM156CQN / DYM1720C / DYM1588EN	19,95
G2641200000	Soporte metálico	G42P/ZE42-E40	12,78
G4661200000	Soporte metálico	G46SL/G51SHL/ZE46-E40	22,67
GLE30000010	Soporte metálico	ZA-380	16,79

**CABLES CORTACÉSPED CAMON - DAYE**

2106800403A	Mando + Cable gas	DYM1626CQ	12,95
2106800412A	Mando + Cable gas	DYM1560CQN DYM1588EN	12,95
2106800211B	Cable tracción	DYM1626CQ	13,95
2106800243B	Cable tracción	DYM1588EN	13,95
2106800428A	Cable tracción	DYM1560CQN	19,95
2106800299A	Cable freno motor	DYM1115EB	9,95
2106800311C	Cable freno motor	DYM1115EB	6,90
2106800001A	Cable freno motor	DYM1661FB	8,90
2106800397A	Cable freno motor	DYM1626CQ	10,60
2106800430B	Cable freno motor	DYM1588EN	9,90

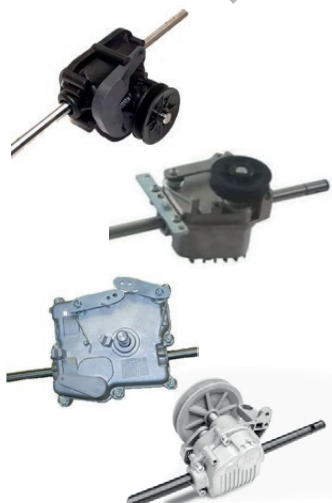
## TRACCIÓN CORTACÉSPED CAMON - DAYE



AI70860560000	Tracción completa	B46T	89,75
AI70860570000	Tracción completa	B51T/H51T	114,75
MA047088	Tracción 12X450,5mm	MA.RI.NA 46/47	159,75
MA051088	Tracción 12X483,5mm	MA.RI.NA 51	169,75
MA053088	Tracción 12X483,5mm	MA.RI.NA 52	169,75
MA056088	Tracción 12X505,5mm	MA.RI.NA 56	181,75
MA047088	Tracción 12X505,5mm	MA.RI.NA 57	159,75
MA057090A	Tracción completa	MX57/HR57	395,75
2102300044D	Tracción completa	DYM1588EN	79,85
G34AP201800	Tracción completa	G46SHL / G51SHL	87,75
2102300071C	Tracción completa	DYM1560CQN / 1626CQ	87,75
2102300063B	Tracción completa	DYM1720C	89,75

## RUEDAS CORTACÉSPED CAMON - DAYE



REFERENCIA	DESCRIPCIÓN	Ø EXT.	Ø INT.	MODELOS	P.V.P SIN I.V.A.
2101100080001D	Rueda delantera	-	-	DYM1661FB	10,90
21011000140001B	Rueda trasera	-	-	DYM1661FB	12,90
21011001560001A	Rueda delantera	-	-	DYM1115EB	10,90
21011001580001A	Rueda trasera	-	-	DYM1115EB	19,95
21011002510001A	Rueda trasera	-	-	DYM1588EN	26,90
21011002660001A	Rueda delantera	-	-	DYM1560CQN DYM1626CQ	16,95
21011002650001A	Rueda trasera	-	-	DYM1560CQN DYM1626CQ	28,90
21011002593208A	Rueda delantera	-	-	DYM1180	10,90
21011002600001A	Rueda trasera	-	-	DYM1180	12,90
21011002600001A	Rueda delantera	-	-	DYM1720C	12,90
21011002610001A	Rueda trasera	-	-	DYM1720C	24,95

## ESCARIFICADOR CAMON



REFERENCIA	ANCHO DE CORTE	ALTURAS DE CORTE	MOTOR	PESO	P.V.P SIN I.V.A.
OSCAR PRO 40H	50 cm	Regulable, cuchillas flotantes	Honda GP160 5,5 HP	65 kg	1.599,63
CESAR 40B	38 cm Incluye Recogedor	Regulable	B&S 550 Series 127 cc	38 kg	708,26

## CUCHILLAS ESCARIFICADORES

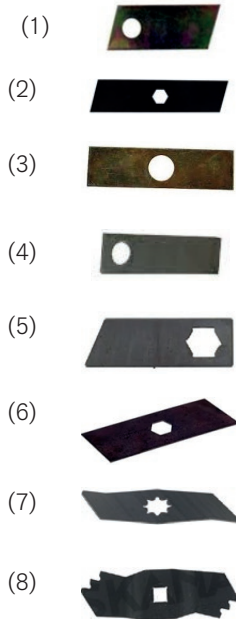

REFERENCIA	CARACTERÍSTICAS	P.V.P. SIN I.V.A.
PU0002020006	1. Cuchilla Oscar Pubert	2,39
PU0002020012	2. Cuchilla Oscar (fija) Pubert	8,19
PB2016180	3. Cuchilla 145x40mm · Ø25 mm · MTD · Pilote	7,90
PB012728B	4. Cuchilla 93mm · Ø13,7 mm · BlueBird · Stiga	3,85
PB78104016B	5. Cuchilla · Ø18 mm · MTD	3,89
PB20184301	6. Cuchilla - Solo · 140 mm · Ø20,3 mm	4,95
PB406131	7. Cuchilla 161 mm · Ø20 mm · Wolf	4,39
PB460773	8. Cuchilla 155x50mm · Ø15 mm · AL.KO · Brill8 (Kit 6 unidades)	30,45

## TRACTORES CORTACÉSPED



REFERENCIA	CARACTERÍSTICAS	P.V.P. SIN I.V.A.
XCH62AE	Motor/Potencia: B&S / 6,5 HP Ancho de corte: 62 cm Nº de cuchillas: 1 Descarga: trasera Transmisión: mecánica Velocidades: 4 adelante - 1 atrás Alturas de corte: 6/30-90 mm Embrague cuchillas: Eléctrico Colector: 130 litros Tipo de chasis: Acero Arranque eléctrico Superficie recomendada: 1.500 m <sup>2</sup> Peso: 130 kg	1.938,57
06.02.202	Cuchilla XCH62A	30,95
D24.0104.0018	Correa cuchillas XCH62A	29,95
D24.0104.0016	Correa tracción XCH62A	26,90
D24.0100.0010	Tracción CPL XCH62A	469,75
CAMON ASSO 67	Motor/Potencia: Loncin OHV-352cc Ancho de corte: 67 cm Nº de cuchillas: 1 Descarga: trasera Transmisión: mecánica Velocidades: 5 adelante - 1 atrás Alturas de corte: 6/30-90 mm Embrague cuchillas: Eléctrico Colector: 130 litros Tipo de chasis: Acero Arranque eléctrico Superficie recomendada: 3.500 m <sup>2</sup> Peso: 145 kg	2.795,00

**TRACTORES CORTACÉSPED**
**NOVEDAD**

**REFERENCIA**
**CARACTERÍSTICAS**
**P.V.P.  
SIN I.V.A.**
**T84M**

Motor/Potencia: Loncin/ 432cc  
 Ancho de corte: 84 cm  
 Nº de cuchillas: 2  
 Descarga: trasera  
 Transmisión: Hidrostática  
 Alturas de corte: 8/30-90 mm  
 Embrague cuchillas: Eléctrico  
 Capacidad recogedor: 280 litros  
 Tipo de chasis: Acero  
 Arranque eléctrico  
 Superficie recomendada: 4.000 m<sup>2</sup>  
 Peso: 230 kg  
 Radio de giro: 45 cm"

**2.675,00**
**NOVEDAD**

**T102**

Motor/Potencia: Loncin/ 452cc  
 Ancho de corte: 102 cm  
 Nº de cuchillas: 2  
 Descarga: trasera  
 Transmisión: Hidrostática  
 Alturas de corte: 8/30-90 mm  
 Embrague cuchillas: Eléctrico  
 Capacidad recogedor: 280 litros  
 Tipo de chasis: Acero  
 Arranque eléctrico  
 Superficie recomendada: 5.000 m<sup>2</sup>  
 Peso: 230 kg  
 Radio de giro: 45 cm"

**2.975,00**



**ACCESORIOS TRACTORES CORTACÉSPED**

REFERENCIA	DESCRIPCIÓN	P.V.P SIN I.V.A.
XCT102-999	Tapón Mulching Kit XCT102	69,75
03.05.1.004	Correa tracción XCT102	39,75
03.05.1.015	Correa cuchillas XCT102	53,90
193401130210	Correa cuchillas Modelo TM 286H	53,95
193406020105	Correa tracción Modelo TTM2102H / 286H	44,69
194001130210	Correa cuchillas Modelo TTM2102H	53,9
06.06.665	Cuchilla izquierda XCT102 / TTM2102H	27,95
06.06.668	Cuchilla derecha XCT102 / TTM2102H	27,95
D40.0103.0102	Tracción Hydro Gear XCT102	850,95

**MOTOAZADAS**

	REFERENCIA	VELOCIDAD ADELANTE	VELOCIDAD ATRÁS	CARACTERÍSTICAS	P.V.P SIN I.V.A.
	NANO 20R	1	-	Motor: R100-98cc Ancho de trabajo: 20/30/46 cm Profundidad: 24 cm Peso: 27 kg	504,20
	ARO 55PC3	2	1	Motor: R-210-212cc Ancho de trabajo: 35/60/85 cm Profundidad: 32 cm Peso: 50 kg	717,39
	ARO 40HC3	2	1	Motor: Honda GP160 -160cc Ancho de trabajo: 35/60/85 cm Profundidad: 32 cm Peso: 50 kg	909,80
	VARIO 55PC3	2	1	Motor: R-210 212cc Ancho de trabajo: 35/60/85 cm Profundidad: 32 cm Peso: 50 kg	793,27

**MOTOAZADAS**

	REFERENCIA	VELOCIDAD ADELANTE	VELOCIDAD ATRÁS	CARACTERÍSTICAS	P.V.P SIN I.V.A.
	<b>MAESTRO 55P</b>	2	1	Motor: 210-212 cc Ancho de trabajo: 60/90 cm Profundidad: 32 cm Peso: 75 kg Manillar ajustable en altura: Si Manillar ajustable lateralmente: Si Transmisión directa	1.302,60
	<b>CW400X8</b>			Par ruedas transporte 400x8 (opcional)	78,90
	<b>SLCWT</b>			Par ejes ruedas transporte (opcional)	15,95
	<b>WM450</b>	1	-	Motor: 4T-95cc Ancho de trabajo: 20/30/42 cm Profundidad: 24 cm Peso: 27 kg	351,96
	<b>GA721</b> <b>RG3.6-75Q-D-11</b>	2	1	Motor: 210 cc - 6,5 Hp Ancho de trabajo: 35/60/80 cm Profundidad: 32 cm Peso: 70 kg Manillar ajustable en altura: Si Manillar ajustable lateralmente: Si	595,00

**MOTOAZADAS**

	REFERENCIA	VELOCIDAD ADELANTE	VELOCIDAD ATRÁS	CARACTERÍSTICAS	P.V.P SIN I.V.A.
	<b>MICRO</b>	1	-	Motor: Honda GX-25	692,37
		Ancho de fresa 45 cm. Peso: 12 kg			
	<b>PU19002300</b>	Kit opcional: escarificador y aporcador (Micro / Nano / MBFW)			179,75



**MOTOCULTORES**



REFERENCIA	VELOCIDAD ADELANTE	VELOCIDAD ATRÁS	CARACTERÍSTICAS	P.V.P SIN I.V.A.
	3	1	Motor: 196cc Ancho de trabajo: 60 cm Profundidad: 32 cm Peso: 90 kg	1.675,48
	Fresa motocultor WMX720			379,75
	2	1	Motor: 196cc Ancho de trabajo: 60 cm Profundidad: 32 cm Peso: 80 kg	1.275,35
	1	1	Motor: RV 170cc Ancho de trabajo: 48 cm Profundidad: 28 cm Peso: 73 kg	1.561,63



## PASADORES Y BULONES ADAPTABLES CAMON

REFERENCIA	DESCRIPCIÓN	P.V.P SIN I.V.A.
PB453652	Pasador/ Pin 7x42	0,59
PB453280	Pasador/ Pin 8x34	0,59
PB453281	Pasador/ Pin 8X40	0,79
PB453283	Pasador/ Pin 8X45	0,79
PB868000	Pasador/ Pin 8X70	0,79
PB453284	Pasador/ Pin 10X40	0,79
PB453285	Pasador/ Pin 10X45	0,79
PB453037	Pasador/ Pin 10x70	0,95
PB405220	Pasador betas diámetro 2 mm x44mm	0,19
PB405221	Pasador betas diametro 3 mm x61mm	0,19
PB405222	Pasador betas diametro 4 mm x75mm	0,29
PB405223	Pasador betas diametro 5 mm x85mm	0,39
PB6404149	Bulón 50X8mm	1,29
PB6404150	Bulón 50X10mm	1,59
PB6901440	Bulón 100x19 mm	6,75
PB6901441	Bulón 160x19 mm	6,95
PB6901442	Bulón 160x22 mm	9,19
CWT0306600	Bulón 110x15 mm	4,95
PB6901443	Bulón 100x16 mm	5,79
PB6901444	Bulón 120x20 mm	6,39

## PASADORES PUBERT

(1)		PU0301030001	(1) Pasador beta 2X50	0,39
		PU0302010039	(2) Pasador de fresas 6X38	1,85
(2)		PU0301010003	(3) Pasador fresas 8x32	2,30
		PU0301010013	(3) Pasador fresas 8x36	1,60
(3)		PU0301010012	(3) Pasador fresas 8x45	1,65
		PU0301010014	(3) Pasador fresas 10x36	1,65
		PU0301010007	(3) Pasador fresas 10x45	4,29
		PU0301010006	(3) Pasador fresas 10x38	3,30

## CUCHILLAS CULTIVADOR PUBERT

	PU0002110010	Cuchilla A	8,93
	PU0002110011	Cuchilla B	8,93

## CUCHILLAS Y FRESAS MOTOAZADAS CAMON

REFERENCIA	DESCRIPCIÓN	Ø	DC	A	MODELOS	P.V.P SIN I.V.A.
CWT0304002	Cuchilla SX	10	68	195	WM500	2,75
CWT0304003	Cuchilla DX	10	68	195	WM500	2,75
270040013-003	Cuchilla SX	10	68	230	GA721	2,95
270040014-003	Cuchilla DX	10	68	230	GA721	2,95
CWT1307001	Cuchilla SX	10	68	230	WM1000	2,90
CWT1307002	Cuchilla DX	10	68	230	WM1000	2,90
CWT0000008	Cuchilla SX	8	55	200	WMX720	3,95
CWT0000009	Cuchilla DX	8	55	200	WMX720	3,95

**ACCESORIOS MOTOAZADAS CAMON - PUBERT**

REFERENCIA	DESCRIPCIÓN	MODELOS	P.V.P SIN I.V.A.
SL715	Kit 24 cuchillas rectas + tornillos y tuercas. $\varnothing$ 8/65x195	Pubet • Pilote • Benassi	69,95
SL716	Kit 24 cuchillas rectas + tornillos y tuercas. $\varnothing$ 10/65x210	Honda	79,95
PU0001000020	Cuchilla recta DX. $\varnothing$ 8/70x205	Pubert	4,79
PU0001000021	Cuchilla recta SX. $\varnothing$ 8/70x205	Pubert	4,79
PU0001000029	Cuchilla helicoidal DX. $\varnothing$ 8,5/70x210	CP550-6210 6210HD-P513GX	4,95
PU0001000030	Cuchilla helicoidal SX. $\varnothing$ 8,5/70x210	CP550-6210 6210HD-P513GX	4,95
PU0320010013	Fresa simple int. DX $\varnothing$ 25 mm Recta	CP550-5110-5112 521/621/721	39,65
PU0320010006	Fresa simple int. DX $\varnothing$ 25 mm Helicoidal	CP550-5110-5112 521/621/721	43,65
PU0320010014	Fresa simple int. SX $\varnothing$ 25 mm Recta	CP550-5110-5112 521/621/721	39,65
PU0320010005	Fresa simple int. SX $\varnothing$ 25 mm Helicoidal	CP550-5110-5112 521/621/721	43,65
PU0320010016	Fresa simple ext. SX $\varnothing$ 25 mm Recta	CP550-5110-5112 521/621/721	41,65
PU0320010012	Fresa simple ext. SX $\varnothing$ 30 mm Helicoidal	6210HD-CP513GX	60,45
PU0320010015	Fresa simple ext. DX $\varnothing$ 25 mm Recta	CP550-5110-5112 521/621/721	41,65
PU0320010011	Fresa simple ext. DX $\varnothing$ 30 mm Helicoidal	6210HD-CP513GX	60,45
CWT0304100	Protector plantas $\square$ 23 mm	WM500	9,95
PU0320010001	Protector plantas $\varnothing$ 25 mm Pubert	Pubert / Honda	13,95
PU0320010002	Protector plantas $\varnothing$ 30 mm Pubert	Pubert / Honda	31,98
PU8000020117	Kit fresas $\varnothing$ 25 mm (helicoidal)	PUBERT (original)	-
PU8000020125	Kit fresas $\varnothing$ 25 mm (rectas)	PUBERT (original)	-
SLJF3A25	Kit fresas $\varnothing$ 25 mm	Pubert / Honda	159,00
WM-3	Kit fresas Exágono $\square$ 23 mm • 350 mm	WM500 / GA721	99,75

DX=derecha / SX=izquierda

**ACCESORIOS PARA MOTOAZADAS CAMON**

	REFERENCIA	DESCRIPCIÓN	MODELOS	P.V.P SIN I.V.A.
	WM-2	Remolque Caja: 120x75 Peso máx: 300kg Rueda: 400x12	WM500 ARO VARIO	598,75
	WM-6	Arado vertedera (1 Polea)	WM500 / GA721	34,95
	WM-5	Arrancador patatas	WM500 / GA721	29,75
	WM-10	Arado aporcador	WM500 / GA721	33,90
	CWTEAS	Enganche arados	WM-6 / WM-5 SLAPWM-9/WM-10	29,75
	SLAP	Arrancador de patatas	WM500 / GA721	49,75
	WM-9	Arado japonés	WM500 / GA721	128,75
	WM-8	Arado vertedera (2 Poleas)	Reversible	163,75
	G004111	Arado japonés	WM500 / GA721	162,75

## ACCESORIOS PARA MOTOAZADAS CAMON

REFERENCIA	DESCRIPCIÓN	DIÁMETRO	P.V.P. SIN I.V.A.
 WM-7	Contrapesofrontal 15 Kg	WM500 / GA721	90,75
 WM-4	Par de ruedas metálicas WM50 con ejes (∅ 23 mm)	320X10	99,75
 WM-11	Contrapesos ruedas 20 Kg	WM500 / GA721	79,75
 CWKIT	Kit surcador Opcional: WM-4	WM500 / WM1000 5110 / 5112 / 550 / 721RA 621RA / 51RGX / ARO	199,75
 CW400X8	Par ruedas neumáticos 400x8	WM500 / WM1000	70,00
 SLCWT	Par ejes ruedas exagonales neumáticos 400x8 (∅ 23 mm)	WM500 / WM1000	15,95
 CW500X12	Par ruedas neumáticos 500x12 + ejes 36 mm	Otras marcas	99,75
 CWT9900005	Rueda + Buje SX 4.80/4.00-8	WM720	87,61
 CWT9900006	Rueda + Buje DX 4.80/4.00-8	WM720	87,61
 VRTL P	Par de ruedas de transporte	Sujección Discos Fresas 3 taladros)	89,75

(se colocan en las fresas)

**ACCESORIOS PARA MOTOAZADAS PUBERT**

REFERENCIA	DESCRIPCIÓN	MODELOS	P.V.P SIN I.V.A.
 PU8000026513	Kit perfilador Eje: 20mm	Pubert: Nano / Tillence Oleo Mac: MH3D/MH3R Sterwins: M30/P36/P40	99,75
 PU8000020704	Kit perfilador Eje: 15mm	Pubert: Micro Oleo Mac: MH2 Mic Sterwins	98,75
 PU8000026511	Kit escarificador Eje: 20mm	Pubert: Tillence Oleo Mac Sterwins	170,85
 PU8100023002	Cresta Giratoria Eje: 20 mm	ARO/ECO/VARIO/ELITE	129,00
 PU8100023004	Cresta Giratoria Eje: 25mm	NANO/MESO/TILLENCE/UNO	129,00
 PU8000020713	Kit 3 funciones	Micro	Consultar
 PU8000020104	Kit aporcador Eje: 25mm Rueda metálica 320x9cm	Pubert: Aro / Vario/Eco/Elite Oleo Mac Sterwins	290,00
 PU8000020119	Kit 3 funciones Eje: 25mm Contrapeso rueda: 21kg Contrapeso delantero: 20kg Rueda neumática 400x8	Pubert: Aro / Vario	1.150,00
 PU8000020109	Kit vertedera Eje: 25mm Contrapeso rueda: 21kg Contrapeso delantero: 20kg Rueda neumática 400x8	Pubert: Aro / Vario Oleo Mac Sterwins	690,00
 PU8000010205	Kit vertedera reversible Eje: 30mm Contrapeso rueda: 30kg Contrapeso delantero: 20kg Rueda neumática 500x10	Pubert: Quatro /senior Oleo Mac Sterwins	1.300,00

**ACCESORIOS PARA MOTOAZADAS PUBERT**

REFERENCIA	DESCRIPCIÓN	MODELOS	P.V.P SIN I.V.A.
 PU8002011307	Arrancador de patatas	ARO / Vario	59,75
 PU8001010001	Arado vertedera	ARO / Vario	120,75
 PU8001010002	Arado aporcador	ARO / Vario	89,75
 PU0320040003	Arado vertedera reversible + Tea	Quatro Senior	399,75
 PU8000020701	Arado	Micro / Nano / MB Fun	85,75
 PU0309000008	Rueda neumática DX	500x10	-
 PU0309000007	Rueda neumática SX	500x10	-
 PU8002011306	Rueda metálica	320x9	74,75
 PU0309000023	Rueda neumática DX	400x8	-
OPU0309000024	Rueda neumática sX	400x8	-

## ACCESORIOS PARA MOTOAZADAS PUBERT



REFERENCIA	DESCRIPCIÓN	MODELOS	P.V.P SIN I.V.A.
PU8002010304	Eje rueda 8 cm · Ø25 mm	Pubert (original)	24,75
PU8002010303	Eje rueda 18 cm · Ø25 mm	Pubert (original)	27,75
PU8002010302	Eje rueda 23 cm · Ø25 mm	Pubert (original)	19,75
PU0303000002	Contrapeso delantero 20kg	Pubert (original)	79,75
PU0303000003	Contrapeso rueda 30kg	500x10	148,75
PU8002010310	Soporte contrapeso delantero	Vario / Aro / Primo	14,90
PU3502010310	Soporte contrapeso delantero	Quatro / 513 / 550	37,90

## CABLES MOTOAZADAS PUBERT · CAMON



PU0308020013	Cable embrague	P15 - ECO	22,90
PU0308020014	Cable embrague (anter. 2006)	5110GX - 5112GX	20,60
PU0308020042	Cable embrague (post. 2006)	5110GX - 5112GX	12,25
PU0308020037	Cable embrague moderno	Quatro Junior / C550GX	17,90
PU0308020033	Cable embrague antiguo	Quatro Junior / C550GX	26,55
PU0308010002	Cable inversor	P115 - P115H	21,60
PU0308020040	Cable embrague	513GX	26,55
PU0308040017	Cable gas x 1350	P15 - P105 - P115	10,75
PU0308040004	Cable gas x 1135	P105H - P115H - 5110GX 5112GX	5,90
PU0308040003	Cable gas x 1100	5110RB - 5112RB	5,45
PU0308040031	Cable gas x 1140	C550GX	7,15
PU0308040039	Cable gas x 1150	CP513GX	23,45
PU0308100002	Cable desbloqueo	Quatro Senior / CP513GX	7,90

## CORREAS MOTOAZADAS PUBERT · CAMON



REFERENCIA	DESCRIPCIÓN	MODELOS	P.V.P SIN I.V.A.
PU0306030003	Correa 13598A (1v)	5110GX-P105-P105H	17,25
PU0306030031	Correa LM 13x1131 (1v) opcional	5110GX-P105-P105H-P15	28,50
PU0306030002	Correa 6841/13567A	CP5112GX-P115-P115H	15,50
PU0306030001	Correa 13493A A46	C550GX-6210-6210HD	19,55
PU0306030057	Correa	521 / 621 / 721 / Vario	17,50
PU0306030101	Correa	513GX/Quatro Senior	29,75

## CORREAS ADAPTABLES MOTOAZADAS PUBERT / HONDA



PB030002	Correa Motoazadas 1+1 velocidad	Pubert / Honda	6,89
PB030001	Correa Motoazadas 2+1 velocidad	Pubert / Honda	9,35
PB030003	Correa Motoazadas 1 veloc. Pubert	Pubert / Honda	11,15

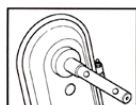
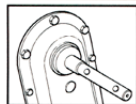
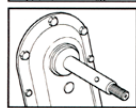
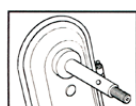

**TRANSMISIONES MOTOAZADAS CAMON - PUBERT**

REFERENCIA	DESCRIPCIÓN	P.V.P SIN I.V.A.
PU3001000013	Abrazadera Primario (rosca y 1 taladro)	199,40
PU3001000005	Tornillos Primario (rosca y 1 taladro)	198,70
PU3001000004	Tornillo Primario (2 taladros)	207,75
PU3001000021	Tornillos modelos: P105 / P115 / 5110GX / 5112GX	180,75
PU3001000018	Abrazadera Primario (2 taladros)	203,75
PU3001000027	Abrazadera modelos: P105 / P115 / 5110GX / 5112GX	178,75

**DESBROZADORAS DE RUEDAS**

REFERENCIA	ANCHO DE CORTE	MOTOR	VELOCIDADES	CARCASA	P.V.P SIN I.V.A.
GA17056	56cm	RV170	-	-	293,33
YUCA 60H	50 cm	GCV200	1	Acero	1.561,48
PAMPA	48cm Alturas de corte regulables	RV170-S	1	Acero	903,76
FIST 55P	51cm Alturas de corte regulables	RV170	1	Acero	1.047,22

**DESBROZADORAS DE RUEDAS**

	REFERENCIA	ANCHO DE CORTE	MOTOR	VELOCIDADES	CARCASA	P.V.P SIN I.V.A.
 <b>NOVEDAD</b>	<b>XPLORER 60P</b>	51cm Alturas de corte regulables	RV225	2	Acero	1.396,28
	<b>XTREM65H</b>	51cm Alturas de corte regulables	Honda GCV190-190cc	Variador de velocidad	Acero	1.914,64
	<b>L JUNIOR 55P</b>	52 cm	RV225	2+1	Acero	2.146,57
	<b>L JUNIOR 65H</b>	52 cm	Honda GSV 190-187cc	2+1	Acero	2.370,13
	<b>TOUNDRA 55P</b>	60cm	RV225	3+1	Acero	2.800,84
 <b>NOVEDAD</b>	<b>TOUNDRA 60H</b>	60cm	Honda GCVx 200	3+1	Acero	3.248,89
	<b>L SENIOR</b>	65 cm	Honda GXV 340 OHV 11 HP	3+1	Acero	3.717,46
	<b>CAMPO</b>	60 cm	B&S	2+1	Acero	3.935,00

## CORREAS DESBROZADORAS DE RUEDAS - PUBERT - CAMON





REFERENCIA	DESCRIPCIÓN	MODELOS	P.V.P SIN I.V.A.
PU0306030048	Correa 057BE	E51 First	8,90
PU0306030051	Correa 11x6,5x856LE	E51 Xtrem	11,80
PU0306030023	Correa tracción 13x718	SENIOR	20,65
PU0306030037	Correa cuchillas 16x1500 (anter. 2008)	SENIOR	38,45
PU0306030052	Correa cuchillas LB59 (post. 2008)	SENIOR	42,95
PU0306030023	Correa tracción 13x718	JUNIOR	20,65
PU0306030036	Correa cuchillas 17x1225	JUNIOR	39,60
PU0306030009	Correa Z25 1/2 10x655L	P51 - E51 - P51H2	10,15
PU0306030008	Correa Z25 10x630L	P51H2	7,80
PU0306030037	Correa cuchillas 16x1500	PL10 - PL20 - PL45	38,45
PU0306030034	Correa tracción LMA1131 13x685	PL10 - PL20 - PL45	19,90

## CABLES DESBROZADORAS DE RUEDAS - PUBERT - CAMON



PU0308040017	Cable gas x1350	E51 - P51H2 (manillar cortacéspedes) Año 97/98	7,90
PU0308030002	Cable regulador alturas		27,20
PU0308050002	Cable freno motor		10,75
PU0308020006	Cable embrague avance		17,10
PU0308040008	Cable gas x1250	E51 año 2003 P51H2 (manillar motoazada)	7,65
PU0308030001	Cable regulador alturas		10,65
PU0308050005	Cable freno motor		12,60
PU0308020029	Cable embrague avance		17,95
PU0308040019	Cable gas x1495	P51H2 (manillar motoazada) año 1.999 y 2.000	7,65
PU0308030003	Cable regulador alturas		13,85
PU0308050007	Cable freno motor		9,75
PU0308020004	Cable embrague avance		15,35
PU0308040019	Cable gas x1495	P51H2 (manillar motoazada) año 2002	7,65
PU0001000440	Cable regulador alturas		17,85
PU0308050005	Cable freno motor		12,60
PU0308020028	Cable embrague avance		17,50
PU0308040040	Cable gas x 1050	E51 First	11,40
PU0308030006	Cable regulador alturas		8,50
PU0308050011	Cable freno motor		7,85
PU0308020039	Cable embrague avance x 940		9,80
PU0308010004	Cable gas	E51 Xtrem	19,20
PU0308030004	Cable regulador alturas		11,15
PU0308050008	Cable freno motor		12,40
PU0308020034	Cable embrague avance		21,45
PU0308040027	Cable variador de velocidad x1450		10,25
PU0308040006	Cable gas x1200	Junior	6,15
PU0307010013	Leva + Cable freno		75,25
PU0308020015	Cable embrague cuchillas		27,95
PU0308020023	Cable avance / atrás		23,85
PU0308040020	Cable gas x 1185	PL45	6,70
PU0308020026	Cable avance / atrás		24,80
PU0308020011	Cable embrague		30,30
PU0308040037	Cable gas x 630	L Senior	7,90
PU0307010018	Cable + leva interruptor pare		127,50
PU0308020023	Cable avance / atrás		23,80
PU0308020011	Cable embrague		30,30

**CUCHILLAS DESBROZADORAS DE RUEDAS - PUBERT - CAMON**

		REFERENCIA	DESCRIPCIÓN	ANCHO CORTE	AGUJERO	GROSOR	MODELOS	P.V.P. SIN I.V.A.
1		PU0320020007	(1) Cuchilla triturar	51 cm	ø 30 mm	5 mm	P51-E51-P51H2-Junior	55,70
		PU0320020002	(2) Cuchilla triscada desbroce	53 cm	ø 30 mm	5 mm	L10 - L50	45,65
2		PU0320020010	(3) Cuchilla de corte	53 cm	ø 30 mm	6,5 mm	L10 - L50	66,65
3		PU0320020003	(4) Cuchilla triturar	63 cm	ø 30 mm	5 mm	PL45	59,10
		PU0320020011	(5) Cuchilla de corte	63 cm	ø 30 mm	6,5 mm	PL45	72,70
4		PU0320020013	(5) Cuchilla de corte	65 cm	ø 30 mm	6,5 mm	L Senior	83,75
		PU0320020012	(1) Cuchilla triturar	65 cm	ø 30 mm	6,5 mm	L Senior	66,35
5		PU0320020031	(1) Cuchilla triturar	65 cm	ø 30 mm	6,5 mm	L Senior	76,35
		PU0320020006	(6) Cuchilla triturar	51 cm	ø 30 mm	5 mm	51 First - 51 Xtrem - Xplorer	53,30
6		PU0320020028	(6) Cuchilla triturar	61 cm	ø 30 mm	6,5 mm	Toundra	77,40

**ACCESORIOS DESBROZADORAS DE RUEDAS PUBERT**



	REFERENCIA	DESCRIPCIÓN	MODELO	P.V.P. SIN I.V.A.
	PU8100020804	Kit cadenas (opcional)	Toundra	189,75
	PU8000020401	Kit cadenas (opcional)	L Junior	198,75
	PU8000020804	Kit cadenas (opcional) 70 cm	L Senior V3	265,75
	PU8100021411	Kit ruedas pivotantes (opcional) 70 cm	L Senior V3	699,75
	PU8100021301	Par ruedas antipinchazos	Toundra	-
	PU8100021302	Par ruedas antipinchazos	L Senior	-

**DESBROZADORAS DE GASOLINA CAMON**



REFERENCIA	CILINDRADA	HERRAMIENTAS DE CORTE STANDARD	PESO	P.V.P SIN I.V.A.
<b>3CS230EF</b>	23cc	Arnés Cabezal de hilo	5,2 kg	151,91
<b>CG260-AE</b>	25 cc	Arnés Cabezal de hilo Disco 3 puntas	5,6 kg	185,69
<b>3GC230A</b>	23cc	Arnés Cabezal de hilo Disco	5,4 kg	174,69
<b>CG415Q33</b>	32cc	Arnés Cabezal de hilo Disco	6,8 kg	184,82



**DESBROZADORAS DE GASOLINA CAMON**

	REFERENCIA	CILINDRADA	HERRAMIENTAS DE CORTE STANDARD	PESO	P.V.P SIN I.V.A.
	<b>CG415Q43</b>	42cc	Arnés Cabezal de hilo Disco	7,7 kg	187,35
	<b>CG415Q52</b>	51,7cc	Arnés Cabezal de hilo Disco	7,7 kg	201,35
 <b>NOVEDAD</b>	<b>BC508T</b>	52cc	Arnés Cabezal de hilo Disco	9,0kg	267,15

**DESBROZADORA DE MOCHILA MOTOR GASOLINA 2T CAMON**

	<b>BG520A-E</b>	51,7 cc	Arnés Cabezal de hilo Disco	11,3 kg	240,00
--	-----------------	---------	-----------------------------------	---------	--------

**SOPLADOR ASPIRADOR GASOLINA CAMON**

REFERENCIA	POTENCIA	VELOCIDAD/CAUDAL	PESO	P.V.P SIN I.V.A.
<b>EBV260E</b>	25 cc 0,9 Hp	Velocidad: 259 km/h Caudal Máximo: 10,2 m <sup>3</sup> /min Capacidad bolsa: 45 litros *Sin Kit de aspiración	4,6 kg	159,50



<b>EB500E</b>	50 cc	Velocidad: 298 km/h Caudal Máximo: 20 m <sup>3</sup> /min	10,9 kg	235,45
---------------	-------	--	---------	--------



<b>EB800E</b>	79,4 cc	Velocidad máx: 326 km/h Caudal Máximo: 24,3 m <sup>3</sup> /min	11 kg	324,06
---------------	---------	--	-------	--------

**PODADOR TELESCÓPICO DE GASOLINA CAMON 2T**

REFERENCIA	POTENCIA	LONGITUD DE TUBO	PESO	P.V.P SIN I.V.A.
<b>QJB270</b>	27,2cc	2900 mm / 4250 mm	8,3 kg	324,06

**PODADOR TELESCÓPICO DE BATERÍA CAMON**

REFERENCIA	DESCRIPCIÓN	PESO	P.V.P SIN I.V.A.
<b>A1828</b>	21V / 5Ah-8"-20cm	3,4	344,52

## MULTICUTTER DE GASOLINA CAMON 2T



REFERENCIA	CILINDRADA	HERRAMIENTAS DE CORTE STANDARD	PESO	P.V.P SIN I.V.A.
GJD330	32cc	Máquina con accesorio cortasetos. Motosierra y rebordeador	6,8 kg	311,41
		Sólo motor		-
MCPGJD330		Accesorio Motosierra		97,35
HTGJD330		Accesorio Cortasetos 40cm		129,35
MCSGJD330		Accesorio Rebordeador		66,35

## HIDROLIMPIADORAS ELÉCTRICAS



REFERENCIA	L/MIN	BARES	POTENCIA	VOLTIOS	AMPERIOS	FASES	P.V.P SIN I.V.A.
YQL16S-130	6	130	1,8 kw	230	7,5	Monofásica	103,56
YQL6.33G-170B	7,3	170	2,4 kw	220-230	10,9	Monofásica	244,03

## HIDROLIMPIADORAS GASOLINA



REFERENCIA	CAUDAL L/MIN	BARES	POTENCIA	P.V.P SIN I.V.A.
GA25010	10,2	250	196cc	464,16



## ACCESORIOS HIDROLIMPIADORA GA25010



REFERENCIA	CARACTERÍSTICAS	MODELOS	P.V.P SIN I.V.A.
RA71010	1. Manguera 8 m. 220bar	GA25010	39,75
RA71200	2. Lanza enchufe rápido	GA25010	19,96
RA71100	3. Pistola	GA25010	39,75
RA710071	4. Boquilla roja	GA25010/YLQ7711E-250	3,95
RA710072	4. Boquilla naranja	GA25010/YLQ7711E-250	3,95
RA710073	4. Boquilla verde	GA25010/YLQ7711E-250	3,95
RA710074	4. Boquilla blanca	GA25010/YLQ7711E-250	3,95
RA710075	4. Boquilla negra	GA25010/YLQ7711E-250	3,95
YLQ7711-99	4. Kit 5 boquillas	GA25010/YLQ7711E-250	16,85
PB22503	5. Filtro agua universal	GA25010/YLQ7711E-250	7,29

## ACCESORIOS HIDROLIMPIADORAS INTERPUMP



REFERENCIA	DESCRIPCIÓN	MODELOS EN QUE SE MONTA			P.V.P SIN I.V.A.
		CL22 GX22	TX10 IPX10	TX13 IPX13	
INZP6T7	Pistola + Manguera 7 m "P6"	●			119,00
IN98401800	Manguera 7 metros	●			89,00
INZZSUP35	Lanza "Quick 4"	●			39,00
INZZFIX35	Lanza FIX35		●	●	39,00
INZZQUICK35	Lanza Quick 35		●	●	39,00
INZREG90	Boquilla "MULTIREG99" regulador 135			●	55,75
INZTXREG135	Lanza con boquilla "QUICK35+MULTIREG135"			●	79,00
INZCHEMKIT	Kit depósito detergente "CHEM KIT"	●			19,00
INZFOAMKIT1	Kit lanza para espuma "FOAMKIT 1"	●			79,00
INZSANDKITO	Kit arenador "SANDKITO"	●			79,00

## MANÓMETROS



REFERENCIA	CARACTERÍSTICAS	P.V.P SIN I.V.A.
IN94582400	Manómetro glicerina • TX10/TX13	27,95
PB63250	250bar Rosca: 1/4"	33,15
PB9401810	160bar Rosca: 1/4"	22,31
PB9401808	60 bar Rosca: 1/4"	20,91
PB9401807	40bar Rosca: 1/4"	20,59
PB9206929	Set herramienta taller para carburadores	42,15
PB9206871	Bomba pedal universal	86,75

**ACCESORIOS HIDROLIMPIADORAS CAMON**

REFERENCIA	DESCRIPCIÓN	MODELOS EN QUE SE MONTA		P.V.P. SIN I.V.A.
		YLQ16-130B	YLQ6-170B	
YLQ170-44	Lanza con boquilla multireg 170B		•	16,90
YLQ130-14	Lanza con boquilla multireg 130B	•		13,95
YLQ130-19	Lanza con boquilla rotativa 130B	•		15,95
YLQ170-43	Lanza con boquilla rotativa 170B		•	17,90
YLQ170-40-1	Manguera 5 metros reforzada		•	39,75
YLQ130-15	Manguera 5 metros 130B	•		20,95
YLQ130-13	Pistola 130B	•		17,95
YLQ170-45	Pistola 170B		•	24,90
YLQ130-998	Kit limpieza tuberías 7,5 m - YLQ130	•		30,95
YLQ170-998	Lanza enchufe rápido - YLQ170		•	20,95

**ACCESORIOS HIDROLIMPIADORA CAMON YLQ7711E-250**

REFERENCIA	DESCRIPCIÓN	P.V.P. SIN I.V.A.
YLQ7711-44	Lanza acople rápido	21,90
YLQ7711-45	Boquilla rotativa	29,95
YLQ7711-50	Pistola	29,75
YLQ7711-33	Boquilla abanico Roja 0°	3,95
YLQ7711-34	Boquilla abanico Naranja 15°	3,95
YLQ7711-35	Boquilla abanico Verde 25°	3,95
YLQ7711-36	Boquilla abanico Blanca 40°	3,95
YLQ7711-37	Boquilla abanico Negra jabón	3,95
YLQ7711-39	Manguera 8 metros	42,75

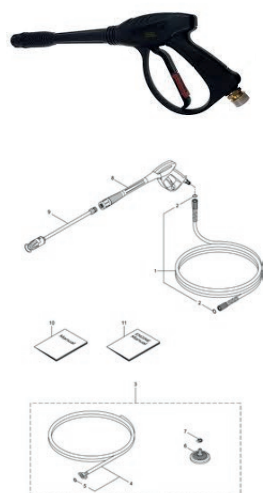
**ACCESORIOS HIDROLIMPIADORA MARUYAMA**

REFERENCIA	DESCRIPCIÓN	P.V.P. SIN I.V.A.
ML131972	Pistola MSW1012 / 1017 / 1515	35,18
ML132678	Lanza + Boquilla	27,97
ML132238	Manguera 8 metros	57,42

## MOTOBOMBAS 2 TIEMPOS



REFERENCIA	DESCRIPCIÓN	ENTRADA SALIDA	LITROS HORA	ALTURA METROS	PESO KG	P.V.P SIN I.V.A.
QGZ25-30	(1) Motor 2T-32,0 cc 1"	25mm	8.000	30	6	164,56

## MOTOBOMBAS 4 TIEMPOS



REFERENCIA	DESCRIPCIÓN	ENTRADA SALIDA	LITROS HORA	ALTURA METROS	PESO KG	P.V.P SIN I.V.A.
QGZ40-20	Motor 4T-98cc Altura de aspiración: 5 m	40mm 1,5"	27.000	20	12	162,99



QGZ50-30	Motor: gasolina 4T Cilindrada: 196 cc Capacidad depósito: 3,6 L Altura de aspiración: 5 m	50mm 2"	32.000	27	23	187,79
----------	--	------------	--------	----	----	--------



QGZ80-30	Motor: gasolina 4T Cilindrada: 196 cc Capacidad depósito combustible: 3,6 L Altura máxima aspiración: 6 m	80mm 3"	34.800	23	25	204,33
----------	--	------------	--------	----	----	--------

## RÁCORES CPL MOTOBOMBAS



REFERENCIA	DESCRIPCIÓN	MODELOS	P.V.P SIN I.V.A.
PB750110	Racord CPL Aluminio 1"	QGZ 25-30	4,95
PB750115	Racord CPL Aluminio 1,5"	QGZ 40-30	5,95
PB750120	Racord CPL Aluminio 2"	QGZ 50-30	6,15
PB750130	Racord CPL Aluminio 3"	QGZ 80-30	7,90
PB750140	Racord CPL Aluminio 4"		11,95

## GENERADORES 4 TIEMPOS

REFERENCIA	DESCRIPCIÓN	PESO KG	P.V.P SIN I.V.A.
WM2500	Motor: gasolina 4T OHV Cilindrada: 196 cc Capacidad depósito combustible: 15 L Salida máxima monofásica: 2500 W / 3,1 Kva	44	416,92
RE3000	Motor: 4 Tiempos 212cc/ Manual Capacidad depósito combustible: 12 L Potencia máxima: 3000W · Voltaje salida: 230	45	398,72
WM3200 WM5500	Motor: gasolina 4T OHV Cilindrada: 212 cc Capacidad depósito combustible: 15 L Salida máxima monofásica: 3200 W / 4,3 Kva	47	465,34
WM5500	Motor: gasolina 4T OHV Cilindrada: 389 cc Capacidad depósito combustible: 25 L Salida máxima monofásica: 5500 W / 6,8 Kva	87	732,26
WM8500	Motor: gasolina 4T OHV Cilindrada: 459 cc Capacidad depósito combustible: 28 L Salida máxima monofásica: 8000 W / 7,5 Kva	102	838,56
RE8500D-T	Motor: 4 Tiempos 459cc / Manual / Eléctrico Capacidad depósito combustible: 25 L Potencia máxima: 8500W · Voltaje salida: 230V/380V	103	869,45

## ACCESORIOS SIERRAS DE PODA A.R.S.

REFERENCIA	DESCRIPCIÓN	P.V.P SIN I.V.A.
GO-1	Spray ARS para limpieza de resina	13,49
9F-10	1. Lima para afilar sierras	19,86
SD-95-PN	2. Lima para afilado de tijeras	20,85
SD-100-BT	3. Lima plana para afilado de tijeras	15,94
SS-240	4. Piedra afilar	13,40

## SIERRAS DE PODA EXTENSIBLE A.R.S.

REFERENCIA	HERRAMIENTAS DE CORTE STANDARD	LONGITUD TOTAL	PESO (GR)	P.V.P SIN I.V.A.
UV-34	1.- Sierra para barra extensible	560 mm	220	37,34
UV-40	Sierra para barra extensible (superturbo)	630	520	95,22
UV-47	2.- Sierra para barra extensible (supertubo)	670 mm	380	83,73
UV-47-1	Cuchilla repuesto UV-47			64,77
EXP-3.3	3.- Barra extensible sin sierra	1,40 a 3,28 m	1.530	140,05
EXP-4.5	3.- Barra extensible sin sierra	1,84 a 4,56 m	1.720	157,18
EXP-5.5	3.- Barra extensible sin sierra	2,00 a 5,56 m	2.100	167,12

## TIJERAS DE PODA EXTENSIBLES A.R.S.



REFERENCIA	HERRAMIENTAS DE CORTE STANDARD	LONGITUD TOTAL	PESO (GR)	P.V.P SIN I.V.A.
180ZR-3.0-5	1. Tijera de poda extensible 3 metros	1,8-3 m	1.185	113,78
180ZR-2.0-3	1. Tijera de poda extensible 2 metros	1,25-2 m	935	107,19
180LR-1.8	1. Tijera de poda fija	1.8 m	615	97,35
185-1,5	2. Tijera de poda fija	1,5 m	1550	103,33

### RECAMBIO TIJERAS DE PODA EXTENSIBLES

180-1	Cuchilla repuesto 180 ZK / 180ZF			21,48
SP-41	Muelle repuesto manecilla 180 ZK / ZF / ZR			0,36
180ZR-1	Cuchilla repuesto ZR / ZF			41,18
185-1	Cuchilla repuesto 185-1.5			51,88

## NAVAJAS DE PODA A.R.S.





REFERENCIA	CARACTERÍSTICAS	LONGITUD TOTAL	PESO (GR)	P.V.P SIN I.V.A.
IK-10-R	Navaja pequeña de poda Especial para Bonsais	220 mm	35	16,51
G-17	Chapado en cromo duro. Afilado curvo y TurboCut. Madera blanda	379 mm	175	29,57
G-17-1	Cuchilla repuesto G-17	-	-	14,94
GR-17	Chapado en cromo duro. Afilado curvo y TurboCut. Madera dura	377 mm	175	32,68
GR-17-1	Cuchilla repuesto GR-17	-	-	18,08

## SERRUCHOS DE PODA A.R.S.



TL-24	Regulable, Niquelado químico. Afilado curvo, Super TURBOCUT. Templado por impulso	406 mm	190	43,58
TL-24-1	Cuchilla repuesto TL-24			23,02
TL-27	Regulable, Niquelado químico. Afilado curvo, Super TURBOCUT. Templado por impulso	437 mm	200	48,24
TL-27-1	Cuchilla repuesto TL-27			25,52
CT-32E	Sierra de poda fija Niquelado químico, Super TURBOCUT	535 mm	230	38,14
DUKE-25	Sierra de poda fija Afilado curvo, TURBOCUT	250 mm	250	32,97
DUKE-25-1	Cuchilla repuesto DUKE-25-1			22,28
CAM-24 PRO	Sierra de poda fija, cromado duro TURBOCUT, acero con carbono	414 mm	280	45,71

## TIJERAS DE PODA ARS PARA SETOS

REFERENCIA	CARACTERÍSTICAS	LONGITUD TOTAL	PESO (GR)	P.V.P SIN I.V.A.
 K-900Z	Para setos, arbustos y césped Telescópica, Niquelado químico	720 a 1.050 mm	950	88,26
 KR-1000	Para setos, arbustos y césped, Cromado intenso	653mm	780	99,03









## TIJERAS DE PODA ARS PARA MANUALIDADES

REFERENCIA	CARACTERÍSTICAS	LONGITUD TOTAL	PESO (GR)	P.V.P SIN I.V.A.
 330HN	Tijera para manualidades hoja recta	160mm	60	14,94
340HT	Tijera multusos	190mm	70	22,90

## TIJERAS DE PODA ARS PARA FRUTA-UVA

REFERENCIA	CARACTERÍSTICAS	LONGITUD TOTAL	PESO (GR)	P.V.P SIN I.V.A.
 310	Tijera para frutas. Hoja curva	160 mm	90	10,46
310BL	Tijera para frutas. Hoja curva	161 mm	91	11,54
310-T	Tijera para frutas. Hoja recta	160 mm	90	12,44
300L	Tijera para frutas. Hoja recta larga	190 mm	110	11,02
300L-BL	Tijera para frutas. Hoja recta larga	190 mm	110	12,44
310DX	Tijera para frutas. Hoja curva, acero inoxidable	170 mm	110	18,98
320 DX-T	Tijera para uva acero inoxidable, hoja recta	150 mm	55	16,61

## TIJERAS DE PODA ARS PARA FRUTALES

REFERENCIA	CARACTERÍSTICAS	LONGITUD TOTAL	PESO (GR)	P.V.P SIN I.V.A.
 1	1.- Para frutales. Chapado en cromo duro	184 mm	150	26,45
 2	2.- Tijera para frutales. Chapado en cromo duro	210 mm	225	27,38
 3	3.- Acero al carbono	202 mm	190	40,47
 4	3.- Acero al carbono	227 mm	210	43,86
 5	4.- Tijeras grandes de poda			29,68
 6	5.- Tijera para frutales. Niquelado químico	205	210	42,98
 7	5.- Tijera para frutales. Niquelado químico	225 mm	230	46,69
 8	6.- Tijera para frutales (yunque). Acero al carbono	205 mm	235	47,96
 9	7.- Tijera para frutales. Niquelado químico	200mm	220	48,21
 10	8.- Tijera para frutales. Niquelado químico Mango giratorio	200mm	265	55,30
	9.- Tijera para frutales. Niquelado químico	227mm	257	52,44
	10. Tijera para frutales. Niquelado químico Mango giratorio	227mm	310	61,09

## TIJERAS DE PODA ARS PARA ARBUSTOS



REFERENCIA	CARACTERÍSTICAS	LONGITUD TOTAL	PESO (GR)	P.V.P SIN I.V.A.
LPB-20S	Para frutales y viñas Grosor máximo: 302 mm	475 mm	825	69,58
LPB-20M	Para frutales y viñas Grosor máximo: 32 mm	624 mm	940	74,85
LPB-20L	Para frutales y viñas Grosor máximo: 34 mm	772 mm	1.055	80,00
LPB-30S	Para frutales y viñas Grosor máximo: 34 mm	482mm	905	73,04
LPB-30M	Para frutales y viñas Grosor máximo: 36 mm	642 mm	1.060	78,25
LPB-30L	Para frutales y viñas Grosor máximo: 38 mm	778 mm	1.135	83,37
LP-40	Para frutales y viñas Grosor máximo: 50 mm	800 mm	1.720	127,97
LPA-30L	Para árboles de fruta y viñas Grosor máximo: 45 mm	806 mm	1080	130,10

## CORTASETOS DE BATERÍA

NOVEDAD



REFERENCIA	CARACTERÍSTICAS	P.V.P SIN I.V.A.
A3758E	Cortasetos batería 14,5V/2,5Ah	119,25

## TIJERAS Y SIERRAS DE BATERÍA



GA183.6	Tijera batería 3,6V-18mm	131,70
A2758E	Tijera batería 14,5V-2,5Ah-25mm	168,50
PS23-25 888380	Tijera batería 10,8V-2,5Ah-23mm	207,69
PS22-32C 884360	Tijera batería 16,8V-2,5Ah-32mm	432,08
J2540	Tijera batería 21,6 V-2,0Ah-37mm	291,16
PS2240 884230	Tijera batería 40V-4,0Ah-40mm	890,90
A1758E	Sierra Bateria 14,5V-2,5Ah-4"/10cm	109,02
A1758EO	Sierra Bateria 14,5V-2,5Ah-4"/10cm-Engrase automático	137,45
CS22-04 885610	Sierra Bateria 10,8V-2,5Ah-4"/10cm	207,69
L2108	Sierra Bateria 21,6V-4Ah-8"/20cm	369,63

## ACCESORIOS TIJERAS/SIERRAS BATERIA

	REFERENCIA	CARACTERÍSTICAS	P.V.P. SIN I.V.A.
	<b>451920</b>	1. Batería 10,8V-2,5Ah · GA2310 / GA10010 / GA1210 / CS2204	39,85
	<b>451860</b>	2. Batería 14,4V-2,5Ah · PS22-25 / PS22-32 / GA3216 / PS2125 / PT22-04	67,20
	<b>451910</b>	3. Batería 40V-4,0Ah · PS22-40	484,47
	<b>5030005010000</b>	4. Batería 21,6V-2,5Ah · GA3721 / GA10025 / PS22-38	67,75
	<b>2150000100000</b>	Batería GA183.6	14,20
	<b>451940</b>	5. Cargador batería 10,8V-2,5Ah · GA2310 / GA10010	55,95
	<b>5022001052000</b>	6. Cargador batería 16V-2,5Ah · PS22-25 / PS22-32 / GA3216 / PS2125	50,75
	<b>5023001051000</b>	7. Cargador batería 21,6V-2,5Ah · GA3721 / GA10025	47,10
	<b>5020210930000</b>	8. Cargador batería 40V-4,0Ah · PS22-40 / GA4040 / CS22-08	66,95
	<b>3040100050000</b>	9. Cuchilla tijera batería · GA2310	29,75
	<b>3040100040000</b>	10. Contracuchilla tijera batería · GA2310	29,75
	<b>3040000200000</b>	9. Cuchilla tijera batería · PS22-25	29,75
	<b>3040100200000</b>	10. Contracuchilla tijera batería · PS22-25	28,63
	<b>3040000000600</b>	9. Cuchilla tijera batería · PS22-32 / GA3216	36,62
	<b>3040100000600</b>	10. Contracuchilla tijera batería · PS22-32 / GA3216	28,91
	<b>3040000000700</b>	9. Cuchilla tijera batería · PS22-40 / GA4040 / GA3721	39,85
	<b>3040100000200</b>	10. Contracuchilla tijera batería · PS22-40 / GA4040 / GA3721	32,03
	<b>3040100150000</b>	Cuchilla GA183.6	18,89
	<b>3040100160000</b>	Contracuchilla GA183.6	18,29
	<b>J2540-35</b>	9. Cuchilla J2540	29,35
	<b>J2540-36</b>	10. Contracuchilla J2540	18,65
	<b>A2758-33</b>	9. Cuchilla A2758	28,75
	<b>A2758-32</b>	10. Contracuchilla A2758	19,86
	<b>A3758E-30</b>	Kit cuchilla pequeña A3758E	19,75
	<b>A3758E-31</b>	Kit cuchilla larga A3758E	29,75
	<b>754710</b>	13. Cartuchera portatijeras	24,90
	<b>L2108-4</b>	14. Batería 21V 4,0Ah L2108 / A1828	72,91
	<b>J2540-1</b>	14. Batería 18V 2Ah J2540	47,39
	<b>A2758-6</b>	15. Batería 14,4V 2,5Ah A2758 / A1758E / A1758EO / A3758E	36,75
	<b>A1758-1</b>	15. Batería 14,4V 1,5Ah A2758 / A1758E / A1758EO / A3758E	31,79
	<b>A1758-30</b>	16. Cargador Batería A1758E / A2758E / A1758EO / A3758E	21,95
	<b>A2758-48</b>	17. Cargador Batería A2758 / A1758 / A3758E	28,95
	<b>J2540-60</b>	Cargador batería J2540 / A1828	29,75
	<b>J2540-62</b>	18. Extensión Cable Batería J2540	43,74
	<b>GA9999</b>	19. Extensión Cable Batería GA3721	38,95



## PÉRTIGAS TELESCÓPICAS BATERÍA



REFERENCIA

CARACTERÍSTICAS

P.V.P  
SIN I.V.A.

7200140

Pértiga para GA2310  
GA10010-CS22-04/PS22-23  
PS23-25 (1,3/2,07m-1,4Kg)

147,69



KH-3GPO21G25.2

Pértiga para GA3721  
(1,7/2,4m-1,4Kg)

183,35



7200170

Pértiga para PS22-32C  
(1,5/2,2m-1,2Kg)

147,69



A0058

Pértiga para A2758/A1758E  
(1,49/2,2m-1,6Kg)

88,64



A0028

Pértiga para J2540/L2108  
(1,49/2,2m-1,8Kg)

88,64

## ATADOR DE BATERÍA



REFERENCIA

CARACTERÍSTICAS

P.V.P  
SIN I.V.A.

PT23-200

Atador batería 16V-2,0Ah

415,00

### ACCESORIOS ATADOR BATERIA

451860

Batería Litio 14,4V 2,5Ah

59,95

5022001052000

Cargador batería 16V-2,0Ah

56,52

571640

Bobina hilo atador 90 m. (BIO) PVC

3,85

571610

Bobina hilo atador 90 m. PVC

3,85

571660

Bobina hilo atador 90 m. Papel

3,85

571760

Bobina hilo atador 200 m (Bio) PVC

6,39



**ROBOTS CORTACÉSPEDES**

REFERENCIA	DESCRIPCIÓN	SUPERFICIE RECOMENDADA M <sup>2</sup>	P.V.P SIN I.V.A.
 TH060L0K9Z	Robot Tech L6-1 Bat. 5Ah-25cm No necesita instalación	200m <sup>2</sup>	1.170,00
 TH020D0F9Z	Robot D.X2-1 Bat. 2,5Ah-18cm	700m <sup>2</sup>	1.198,57
 TH020R0K1Z	Robot L.X2-ZR1 Bat.2,5Ah-18cm No necesita instalación	1.000m <sup>2</sup>	1.654,29
TH020L4F1Z	Robot L.X2-1 Bat.2,5Ah-18cm	1.000m <sup>2</sup>	1.524,29
 TH025L4K1Z	Robot L.X2.5-1 Bat.5Ah-25cm	1.800m <sup>2</sup>	1.954,29
 TH029L4G1Z	Robot L.X2.9- 2 Bat.5 Ah-29cm	3.500m <sup>2</sup>	2.584,29
 TH095L4G1Z	LQ Cross-29cm	3.500m <sup>2</sup>	5.035,71
TH040L401Z	Robot LX 4, sin unidad de potencia-25cm	1.800m <sup>2</sup> 3.200m <sup>2</sup>	2.792,86
TH040L413Z	Robot LX 4-4WD sin unidad de potencia-25cm	1.800m <sup>2</sup> 3.200m <sup>2</sup>	3.205,71
TH043L401Z	Robot LX 6, sin unidad de potencia-36cm	6.000m <sup>2</sup>	3.408,57
TH043L413Z	Robot LX 6-4WD, sin unidad de potencia-36cm	6.000m <sup>2</sup>	3.848,57
-	Robot LX 4-U-RTK, sin unidad de potencia	5.500m <sup>2</sup>	4.548,00
TH043L504Z	Robot LX 6-U-RTK, sin unidad de potencia	10.000m <sup>2</sup>	5.224,29
 TH450D4M1	D40i 4x15Ah-84cm	20.000m <sup>2</sup>	

**UNIDADES DE POTENCIA**

<b>Medium</b>	40PUK05M90	Medium 5.8Ah - Para BX 4 / LX 4	682,86
<b>Premium</b>	40PUV08P90	Premium 8,7 Ah - Para BX 4 / LX 4	787,14
<b>Extra Premium</b>	40PUV08I90	Extra Premium 8,7 Ah - Solo para LX 4	1.132,86
<b>Ultra Premium</b>	40PUG10P90	Ultra 10,3 Ah - Solo para LX 6	951,43

**ACCESORIOS ROBOTS CORTACÉSPEDES CAMON**

REFERENCIA	DESCRIPCIÓN	MODELOS	P.V.P SIN I.V.A.
015Z11800A	Tapa base recarga	DX2/LX2	-
L29Z04410A	Tapa base recarga	LX2.5/LX2.9	-
075Z45800A	Tapa base recarga	LX4/LX6	-
CSE00020S	Hilo Robot 100 metros - 1x1,5 - ø 3 mm		-
CSE0002	Hilo Robot 150 metros - 1x1,5 - ø 3 mm		-
CSE00022	Hilo Robot 200 metros - 1x1,5 - ø 3 mm		-
CSE00023	Hilo Robot 300 metros - 1x1,5 - ø 3 mm		-
CSE00025	Hilo Robot 500 metros - 1x1,5 - ø 3 mm		-
200A00200A	Bolsa 200 ud. pincho fijación cable		-
PB999999	Bolsa 100 ud. pincho fijación cable		-
CSD0155	Disco cuchilla 4D 22 cm		-
50D001801	Disco cuchilla 4D 25 cm		-
CSD011202	Disco cuchilla 4D 29 cm		-
300D004204	Disco cuchilla 4D 35 cm		-
050Z060000A	Disco cuchilla 8D 42 cm		-
200Z01300A	Rueda dentada		-
CSC0106BTR	Batería litio 25,9V 7,5 Ah		-
075Z60900AR	Batería litio 25,9V 5 Ah Lx 2.5/D6/DZ2		-

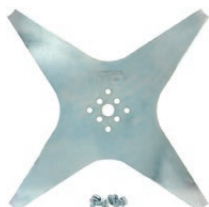

## PULVERIZADOR DE MOCHILA CAMON



REFERENCIA	MOTOR	DESCRIPCIÓN	P.V.P SIN I.V.A.
3WZ-6F	1E34F-32cc	Capacidad depósito 20L Caudal: 7 L Presión: 0-2,5 MPa Longitud manguera: 10m Peso: 9,8 Kg	210,14
SH2320012238		Manguera pulverizador CPL Ø 7,5 mm	15,90
SH999999		Lanza pulverizador 3WZ-6F	17,90

## PULVERIZADOR DE BATERÍA CAMON



REFERENCIA	MOTOR	DESCRIPCIÓN	P.V.P SIN I.V.A.
WS-15DA	Bateria 12V-7Ah	Capacidad depósito 15L Tiempo de recarga: 6 horas Presión: 0-2,5 MPa Autonomía batería: 6/8 horas. Peso: 6,2Kg	105,31
GA12-10	Bateria 10,8V-2Ah	Capacidad depósito 0,95L Tiempo de recarga: 2 horas Presión: 12 Bar Autonomía batería: 2 horas. Peso: 0,94Kg	118,79

## AHOYADORES CAMON



REFERENCIA	CARACTERÍSTICAS	P.V.P SIN I.V.A.
3WT-500A	Cilindrada: 51,7 cc Diámetro eje : 22 cm Peso: 9,5kg Profundidad: 1,40 m Incluye broca Ø 150 mm Diámetro max. broca: 200mm Ø 19,5 mm	278,49

## ACCESORIOS AHOYADORES CAMON





SH2320076757	Broca ø - 80 mm	55,95
SH2320076224	Broca ø - 100 mm	62,90
SH2320076024	Broca ø - 150 mm	69,90
SH2320076026	Broca ø - 200 mm	91,75

## CARRETILLAS DE PULVERIZAR

	REFERENCIA	MOTOR	DESCRIPCIÓN	P.V.P SIN I.V.A.
	<b>60-2R</b> 2 RUEDAS	4T-35cc 1,1 Hp	Capacidad depósito 60L Bomba de pistones Caudal: 10,5L Presión: 30 atm Longitud manguera: 10 m Peso: 28 kg	708,96
	<b>100-1R</b> 1 RUEDA	4T-35cc 1,1 Hp	Capacidad depósito 100L Bomba de pistones Caudal: 10,5L Presión: 30 atm Longitud manguera: 10 m Peso: 36 kg	738,81

## ACCESORIOS CARRETILLAS DE PULVERIZAR

	REFERENCIA	DESCRIPCIÓN	P.V.P SIN I.V.A.
	<b>V-101</b>	Pistola	25,95
	<b>V-105</b>	Manguera 10 m	29,90



## CARRETILLA MOTORIZADA

	REFERENCIA	MOTOR	VELOCIDADES	PESO	CARGA MÁXIMA	P.V.P SIN I.V.A.
	<b>MTRP85B35</b>	RV-170	1 adelante 1 atrás	56 kg	100 kg	945,67
	<b>MTRP85H45</b>	Honda GCV140	1 adelante 1 atrás	56 kg	100 kg	1189,00

## ACCESORIOS CARRETILLA MOTORIZADA

	REFERENCIA	CARACTERÍSTICAS	P.V.P SIN I.V.A.
	<b>00350025255</b>	(1) Correa Z34 10x865	19,90
	<b>00351005200</b>	(1) Correa x10772LP	24,95
	<b>00260050927</b>	(1) Correa 1060x10	31,90
	<b>00341005132</b>	(2) Rueda trasera 170x50 D 20 DX/SX	30,95
	<b>00330015004</b>	(3) Rueda delantera. DX 13x5,00-6	79,75
	<b>00350015000</b>	(3) Rueda delantera SX 13x5,00-6	79,75
	<b>00350015150</b>	(4) Rueda maciza DX 4,00-6 (opcional)	89,00
	<b>00350015151</b>	(4) Rueda maciza SX 4,00-6 (opcional)	89,00
	<b>00350010120</b>	(5) Cable retromarcha	15,95
	<b>00350010110</b>	(5) Cable tracción	22,95
	<b>00350025100</b>	(5) Mando + Cable Gas B&S	17,95
	<b>00350010100</b>	(5) Cable Plataforma	15,95

**BIOTRITURADORES DE GASOLINA CAMON**

REFERENCIA	MOTOR	DESCRIPCIÓN	P.V.P SIN I.V.A.
 <b>TPS650</b>	4 tiempos 212cc/7,5 HP	Potente motor de 4T-212cc Sistema de triturado combinado cuchillas/martillos Diámetro máximo de ramas 75mm Sistema de arranque manual	735,25
 <b>TPS700</b>	4 Tiempos-170F 212cc/7,5 HP	Potente motor de 4T-212cc Sistema de triturado combinado cuchillas rotativas Diámetro máximo de ramas 70mm Descarga elevada y orientable Sistema de arranque manual	783,58
 <b>TPS1500W</b>	4 Tiempos-190F 420cc/15,0 HP	Potente motor de 4T-402cc Sistema de triturado combinado cuchillas rotativas Diámetro máximo de ramas 120mm Descarga en altura y orientable Sistema de arranque manual/eléctrico	1.670,15

**MÁQUINAS DE BATERÍA CAMON**

REFERENCIA	CORTE	TIPO DE BATERÍA	RECOGEDOR	PESO	CARCASA	MOTOR	P.V.P SIN I.V.A.
 <b>Cortacésped de batería sin tracción</b> <b>ZE42-E40</b>	Ancho 41,5cm Alturas 6 25-75 500 m <sup>2</sup>	40V	45 litros	23 Kg	Acero	800W	273,31
 <b>Cortacésped de batería con tracción</b> <b>ZE46-E40</b>	Ancho 46 cm Alturas 7 25-75 800 m <sup>2</sup>	40V	65 litros	30 Kg	Acero	1.200W	368,79
 <b>Cortasetos de batería</b> <b>ZE40HT23</b>	Longitud de corte: 58 cm Separación entre cuchillas: 23 mm Asa trasera giratoria 180°	40V		3,1 Kg		350w	109,48

\*Los P.V.P. no incluyen batería ni cargador

## MÁQUINAS DE BATERÍA CAMON

REFERENCIA	DESCRIPCIÓN	TIPO DE BATERÍA	CADENA VELOCIDAD / AMPERAJE	PESO	MOTOR	P.V.P SIN I.V.A.
 <b>Desbrozador de batería</b> <b>ZE40BC10</b>	Herramientas de corte standard: Cabezal de nylon	40V		2,8 Kg	500W	161,34
 <b>Motosierra de batería</b> <b>ZE40CS12</b>	Longitud de barra 12"/30cm	40V	Tipo de cadena: 1/4-45E	3,8 Kg.	1,200W	181,51
 <b>Soplador de batería</b> <b>ZE40BW27</b>	Volumen Máx 8,1 m <sup>3</sup> /min	40V	Velocidad máx: 88/120km/h	2,2 Kg	-	61,94 €

\*Los P.V.P. no incluyen batería ni cargador

## GAMA BATERÍAS

REFERENCIA	DESCRIPCIÓN	VOLTAJE	AMPERAJE	PESO	P.V.P SIN I.V.A.
 <b>ZE40B2,5</b>	Batería de litio 40V-2,5Ah	40V	2,5Ah	0,9 Kg	92,20
<b>ZE40B4</b>	Batería de litio 40V-4,0Ah	40V	4,0Ah	0,9 Kg	121,01

## GAMA CARGADORES

REFERENCIA	DESCRIPCIÓN	VOLTAJE	AMPERAJE	PESO	P.V.P SIN I.V.A.
 <b>ZE40C2</b>	Cargador baterías 40V/2Ah	40V	2,0 Ah	0,95 Kg	38,90
<b>ZE40C5</b>	Cargador baterías 40V/5Ah	40V	5,0Ah	1,1 Kg	54,74

**MOLINOS DE CEREALES ELÉCTRICOS CAMON**

REFERENCIA	DESCRIPCIÓN	P.V.P. SIN I.V.A.
<b>MBIDON 50L</b>	Molino CAMON 1,5 cv (Bidón 50 L) 3 cribas ø 2, 4, 6 mm	239,20

**ACCESORIOS MOLINOS MILLY Y CAMON**

	REFERENCIA	DESCRIPCIÓN	P.V.P. SIN I.V.A.
1	 <b>MBIDON50L-14-2</b>	1.- Criba ø 2 mm molino Camon	6,95
	<b>MBIDON50L-14-4</b>	1.- Criba ø 4 mm molino Camon	6,95
	<b>MBIDON50L-14-6</b>	1.- Criba ø 6 mm molino Camon	6,95
	<b>MBIDON50L-14-8</b>	1.- Criba ø 8 mm molino Camon	6,95
2	 <b>MBIDON50L-12</b>	2.- Cuchilla molino Camon	2,95
	 <b>MBIDON50L-99</b>	3. Interruptor MBIDON 50L	13,75
4	 <b>MBIDON50L-16</b>	4. Cubo verde 50L	19,95
5	 <b>MBIDON50L-08</b>	5. Motor MBIDON 50L	139,75
6	 <b>MBIDON50L-03</b>	6. Tolva Molino 50L	9,55
7	 <b>MBIDON50L-10</b>	7. Tapa cubo 50L	39,75



PICADORAS DE LEÑA

	REFERENCIA	CARACTERÍSTICAS	P.V.P SIN I.V.A.
1	HLS7T-52 (1)	Carrera: 520 mm. Diámetro máx.: 300 mm. Fuerza máx.: 7 toneladas Motor eléctrico 230 V - 2100W Peso: 45 kgs.	369,47
	HLS7T-52 /ST19	Caballete para HLS7T-52	57,55
2	HLS7T-52-01 (2)	Carrera: 520 mm. Diámetro máx.: 300 mm. Fuerza máx.: 7 toneladas Motor eléctrico 230 V - 2100W Peso: 45 kgs. • <b>Incluye caballete</b>	379,45
3	HLSP10TS (3)	Carrera: 790 mm Diámetro máx.: 500 mm Fuerza máx.: 8 toneladas Motor eléctrico 230 V - 3000W Peso: 116 kg	894,03
4	VHLS10T (4)	Carrera: 790 mm Diámetro máx.: 500 mm Fuerza máx.: 8 toneladas Motor eléctrico 230 V - 2100W Mesa de trabajo 5 posiciones Peso: 98 kg	945,67
5	VHLS12TG (5)	Carrera: 790 mm. Diámetro máx.: 500 mm. Fuerza máx.: 8 toneladas Motor gasolina 4 tiempos 196cc Mesa de trabajo 5 posiciones Peso: 119 kg	1.069,75
6	L36T (6)	Carrera: 600 mm. Diámetro máx.: 550 mm. Fuerza máx.: 335 toneladas Motor gasolina 4 tiempos 270cc Mesa de trabajo 2 posiciones Peso: 119 kg	2.186,57
	HLS7T-52 /ST06	Caballete para HLS7T-52	-



# ■ ACCESORIOS



 **MARLYAMA**

 **Simplicity**

 **CAMON**  
OUTDOOR POWER EQUIPMENT

 **WOODLINE**

## BARRAS SIERRAS DE BATERÍA



REFERENCIA	TAMAÑO / PASO	MODELOS	P.V.P SIN I.V.A.
TC404329	Barra 4" 1/4" PicoMicro 0,43" 29E	GA10010/CS22-04	10,75
2200030010000.	Barra 9" 1/4" PicoMicro 0,43" 48E	GA20025	25,96
A1758-17	Barra 4" 1/4" PicoMicro 0,43" 28E	A1758 / A1758EO	9,95
L2108-13	Barra 8" 1/4" PicoMicro 0,43" 47E	L2108 / A1828	14,96
6KM4-HL-BB	Barra 6" 1/4" PicoMicro 0,43" 38E	GA10025	12,95
8KM4-HL-BB	Barra 8" 1/4" PicoMicro 0,43" 47E	Otros modelos	14,95
TC504334	Barra 5" 1/4" PicoMicro 0,43" 34E	CS22-06	19,9

## BARRAS LAMINADAS ADAPTABLES CAMON



REFERENCIA	TAMAÑO / PASO	Nº GUÍAS	P.V.P SIN I.V.A.
TC201699	Barra 10"/25cm · 3/8LP · 0,50 · 1,3mm	40DL	11,90
TC201700	Barra 12"/31cm · 3/8LP · 0,50 · 1,3mm	45DL	12,90
TC201409	Barra 14"/36cm · 3/8LP · 0,50 · 1,3mm	52DL	14,90
TC201704	Barra 16"/41cm · 3/8LP · 0,50 · 1,3mm	56DL	15,95
P016-5DSR	Barra 16"/42cm · 3/8LP · 0,50 · 1,3mm	57DL	19,90
TC201705	Barra 18"/46cm · 3/8LP · 0,50 · 1,3mm	62DL	16,90

### ANCLAJE ADAPTABLE A LOS SIGUIENTES MODELOS

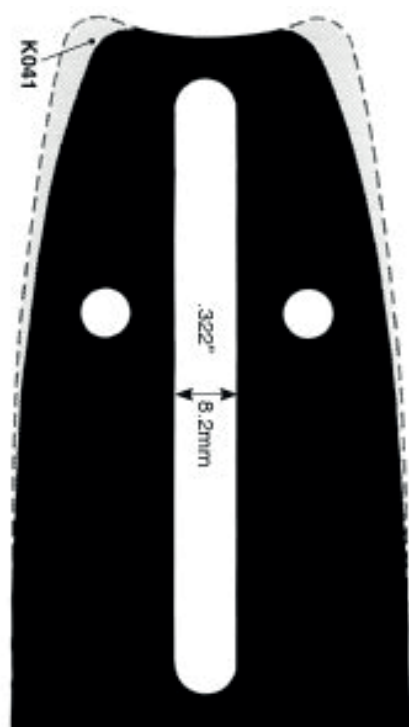

CAMON	C26, C37, C41, TCS2600, TCS4100, GY9303, YT4302, YT4632
DOLMAR	100, 101, 102, 103, 104, 105, 106, 108, 200, 260, 270, 290, ES-161, ES-171, PS-34, PS-340, PS-341, PS-400, PS-401, PS-3300th
ECHO	CS-280, CS-290, CS-300, CS-301, CS-302 (AFTER #0015304), CS-302S, CS-305, CS-306, CS-315, CS-330, CS-330T, CS-341, CS-346, CS-351 (AFTER #0112195), CS-360T, CS-400, CS-440, CS-510, CS-3000, CS-3400, CS-3450, CS-3600, CS-3900, CS-4000, CS-4100, CS-4400, CS-4500, CS-4600, CS-5000, ECS-2000, ECS-3000
HOMELITE	20, 20AV, 23AV, 25, 27, 3300, 3350, 3800, 3850, 4100, 4150, 4500, 4550, d3350b, d3850b, d4550b, i3350b, PS33, TIMBERMAN, UT10896, UT10901, UT10901A, UT10910, UT10926, UT10927, UT10942, UT10946, UT10947, z3350
HUSQVARNA	23, 36, 41, 136, 141, 243, Electric 16
JOHN DEERE	25EV, 28, 28V, 30, 30V, 35EV, 40V, 45EV, 46EV, 200CS, 230CS, 300CS, 450V; JOHN DEERE PRUNERS, Quick-tatch series: PS2383, PS2683, PSA10
JONSERED	2014, 2016, 2035, 2036, 2036 TURBO, 2037, 2040, 2040 TURBO, 2041, 2045, 2050, 2050 TURBO, 2054, 2135, 2137, 2138, 2141, 2145, 2150, 2152, 2152W
MAKITA	DCS34, DCS330S, DCS340, DCS341, DCS390, DCS390S, DCS400, DCS401, 5012B, 5014NB, 5016NB, UC3500, UC4000
MARUYAMA	MCV3100TS, MCV331T, MCV381, MCV3900, MCV4000, MCV3100S, MCV3101S, MCV3501S
McCULLOCH	MS 4016P, MS 4018P, MAC335, MAC842
MTD	125, 136, 140S
OLEO MAC	925F, 932C, 936F
POULAN/POULAN PRO	2150, 2155, 2175, 2250, 2300, 2350, 2400, 2450, 2500, 2550, 2600, 2700, 2750, 2775, 2800, 2900, 3000, 3050, 3100, 3300, 3500, 3600, E14E, E16E, ELECTRIC PRO 400E, MICRO 25
PARTNER	P33, 335, 345, 350, 351, 351XT, 352, 370, 401, 422, 420, Formula 5000

\* Compatible con Oregon A041

## BARRAS LAMINADAS ADAPTABLES CAMON

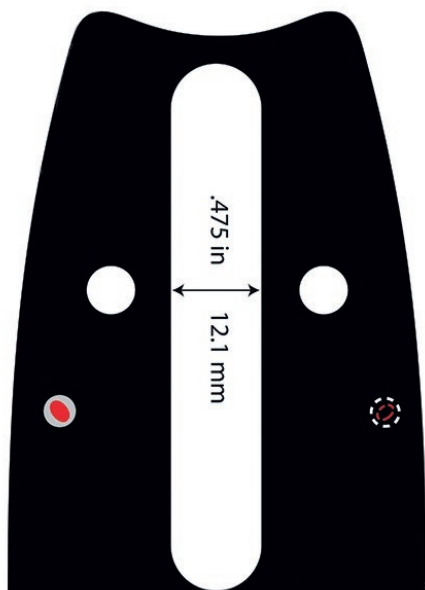

\* Compatible con Oregon D025



REFERENCIA	TAMAÑO / PASO	Nº GUÍAS	P.V.P. SIN I.V.A.
TC301866	Barra 18" · 3/8 - 0,63 66E	66DL	25,75
TC301870	Barra 16" · 325 - 0,63 67E	67DL	23,75
TC301874	Barra 18" · 325 - 0,63 66E	74DL	25,75

### ANCLAJE ADAPTABLE A LOS SIGUIENTES MODELOS

STIHL 3/8"	038, 441, 461, 462, 311, 391, 362, 440, 460
STIHL 325"	261, 271, 290, 270, 280

REFERENCIA	TAMAÑO / PASO	Nº GUÍAS	P.V.P. SIN I.V.A.
200SLHD176	Barra Oregon 20" · 3/8 · 1,3mm	72DL	57,75
PB620000	Barra Camon 20" · 3/8 · 1,3mm	72DL	27,75

### ANCLAJE ADAPTABLE A LOS SIGUIENTES MODELOS

CAMON	C62, TCS6200
ECHO	CS-60, CS-451, CS-452, CS-500, CS-501, CS-501EVL, CS-510EVL, CS-550, CS-601, CS-602, CS-60S, CST-610, CS-650, CS-660, CS-701, CS-702, CS-706, CS-750, CS-5500, CS-6700, CS-8000
GREEN MACHINE	7600, 7700
JOHN DEERE	50V, 51SV, 55SV, 60V, 65, 65SV, 66SV, 70V, 80EV, 800V, 50AV, 55V
LOMBARD	AP-42, Super Lightning, Lightning III, Comango, CS-3500, CS-3501, CS-3502, CS-3503
McCULLOCH	1-10, 2-10, 3-10, 4-10, 5-10, 6-10, 7-10, 10-10, 10-10A, 55, 57, 60, 80, 555, 560, 570, 605, 610, 650, 655, 700, 800, 805, 850, 1000, 3720, CP55, CP70, CP70L, Double Eagle 50, 80, Eager Beaver 3.7, PM605, PRO MAC 55, 5700, 8200, SILVER EAGLE 3420, SP-60, SP-70, SP-80, SP-81, Timber Bear, TITAN 50, TITAN 57, Titan 70
POULAN/POULAN PRO	203, 245, 306, 360, 375, 361, 395, 400, 450, 3400, 3700, 3800, 3900, 4000, 4200, 4400, 4900, 5200, 5400, 5500, 6700
SKIL	1641
TANAKA	ECS-505, ECS-506, ECS-650, ECS-655
ZENOAH	G621

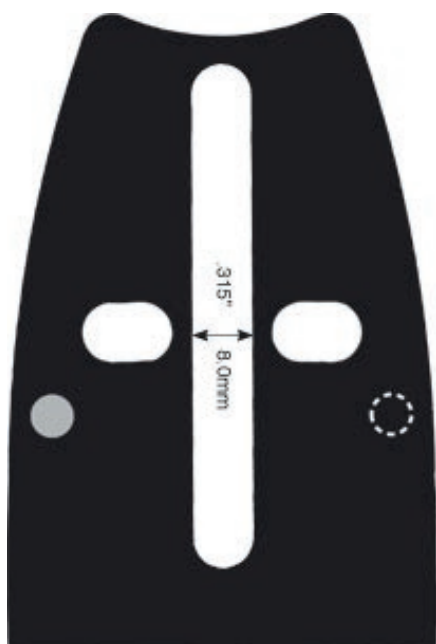

\* Compatible con Oregon D176

**BARRAS LAMINADAS ADAPTABLES CAMON**

REFERENCIA	TAMAÑO / PASO	Nº GUÍAS	P.V.P. SIN I.V.A.
TC201403	Barra 15"/38cm · 325 · 0,50 · 1,3mm	64DL	19,95
TC201690	Barra 15"/38cm · 325 · 0,58 · 1,5mm	64DL	21,90
TC201703	Barra 18"/46cm · 325 · 0,50 · 1,3mm	72DL	23,95
TC201693	Barra 18"/46cm · 325 · 0,58 · 1,5mm	72DL	23,95

**ANCLAJE ADAPTABLE A LOS SIGUIENTES MODELOS**

CAMON	C45, C50, TCS4600, TCS5000
ALPINA/CASTOR	A-40, C-40, CP-41, CP-45, CP-540, CP-600, P-370, P-410, P-460, P-510, PRO-41, PRO-45, PRO-540, PRO-600
CUB CADET	CS5018, CS5220, CS5720
DOLMAR	109, 110, 110 EX, 111, 112, 113, 114, 115, 116si, 117, 118, 119, 120, 120si, 120 SUPER, PS-6800
HOMELITE	30, 130, 150, 150 AO, 250, 252, 290, 300, 340, CS 40, CS 50, EZ 250, MINI SL, SUPER EZ AO, XL-76, XL-100 SERIES
HUSQVARNA	33, 36, 38, 40, 41, 42, 44, 45, 49, 50, 51, 55, 55 Rancher, 57, 133, 136, 140, 140S, 141, 154, 234, 238, 240, 242, 246, 254, 257, 261, 262, 335, 336, 339XP, 340, 345, 346, 350, 351, 353, 357XP, 359, 360, 362, 444, 455 Rancher, 1400, 1600
JOHN DEERE	CS46, CS52, CS56, CS62
JONSERED	45, 49, 50, 51, 52, 370, 410, 420, 425, 435, 450, 451, 455, 490, 510, 520SP, 521, 525, 535, 590, 941, 2050, 2051, 2054, 2055, 2063, 2141, 2145, 2149, 2149 TURBO, 2150, 2152, 2159
MAKITA	DCS 430, DCS 431, DCS 520i, DCS 5200i, DCS 6000i
MARUYAMA	POLESAWS: MC-PL11, MC-PS11, MCV5100S, MCV5600
McCULLOCH	1849 AV, 2046 AV, 2049 AV, 4600, 4700, 4900, 5000, 5500, MS 1434, MS 1436, MS 1636, MS 1839, MS 1846, MS 1849, MS 1850, MS 2046, MS 2049, MS 2050, PM 1845 AV, Pro Mac: 40, 46; Silver Eagle: 2818, 3020; Timber Bear, Timber Bear 20
MTD	152, 162
OLEO MAC	941, 945, 950, 951
PARTNER	410, 510, 540, P-360, P-400, P-450, P-500, P-5000, 411, 4200, 405, 470, 511, 543, 4600, 5200
PIONEER	1074, P-21, P-26, P-28
POULAN/POULAN PRO	325
REDMAX	G390, G450AVS, G455AVS, G3800
RYOBI	RFS4518, RFS5418
SEARS	35084, 35201
SOLO	614, 630, 631, 632, 638, 639, 641, 644, 645, 647, 650, 651, 651SP, 654



\* Compatible con Oregon K095

## BARRAS LAMINADAS ADAPTABLES CAMON



REFERENCIA	TAMAÑO / PASO	Nº GUÍAS	P.V.P SIN I.V.A.
CA1681A260TC	Barra 16"/40cm · 3/8 · 0,58 · 1,5mm	60DL	20,90
TC201696	Barra 17"/43cm · 3/8 · 0,58 · 1,5mm	64DL	23,90
TC201697	Barra 18"/46cm · 3/8 · 0,58 · 1,5mm	68DL	23,90
TC201698	Barra 20"/50cm · 3/8 · 0,58 · 1,5mm	72DL	25,95

## BARRAS CON PUNTERA ADAPTABLES CAMON



REFERENCIA	TAMAÑO / PASO	Nº GUÍAS	P.V.P SIN I.V.A.
SHV16-58ER	Barra 16"/40cm · 3/8 · 0,58 · 1,5mm	60DL	19,75
SHV18-58ER	Barra 18"/46cm · 3/8 · 0,58 · 1,5mm	68DL	31,95
TC201681	Barra 20"/50cm · 3/8 · 0,58 · 1,5mm	72DL	39,90

## ANCLAJE ADAPTABLE A LOS SIGUIENTES MODELOS

ALPINA	660, 650, 600
DOLMAR	PS-6400, PS-7300, PS-7900, PS-9000, PS-9010FL
HUSQVARNA	61, L SERIES: 65, 66, 70, 77; 160, 162, 181, 185, 260, 266, 268, 272, 281, 285, 288, 288XP Lite, 298, 365, 371, 372XPW; 380, 385, 385XP, 385XPG, 385XPW, 394, 395, 395XP, 395XPW, 480, 570, 1100, 2100, 2101, 3120, 3120XP, Jungle 3120
JONSERED	625, 630, 630 SUPER, 630 WEST COAST, 670, 670 WEST COAST, 2063, 2065, 2071, 2077, 2083, 2094, 2095, 2163, 2165, 2171, CS-2186, RIPPING MILL
MAKITA	DCS 6401, DCS 6800i, DCS 7301, DCS 7901, DCS 9000, DCS 9010FL
PARTNER	550, 650, 1655, 2055, 7000, P-55, P-65, P-70, P-85, P-100, R-11, R-12, R-14, R-16, R-17, R-18, R-19, R-20, R-21, R-22, R-23, R-30, R-35, R-40, R-416, R-420, R-421, R-435, R-440, S-50, S-55, S-65, 660, 710, 7700
POULAN/POULAN PRO	415, 425, 445, 475, 505
SHINDAIWA	(SDK) 550, 575, 577, 680, 695, 757
SOLO	603, 662, 665, 667, 667SP, 670, 675, 680, 681, 690, 694



\* Compatible con Oregon D009

## BARRAS LAMINADAS ADAPTABLES CAMON



REFERENCIA	TAMAÑO / PASO	Nº GUÍAS	P.V.P SIN I.V.A.
CA1629N155HC	Barra 16"/40cm • 3/8BP • 0,50 • 1,3mm	55DL	16,95

### ANCLAJE ADAPTABLE A LOS SIGUIENTES MODELOS

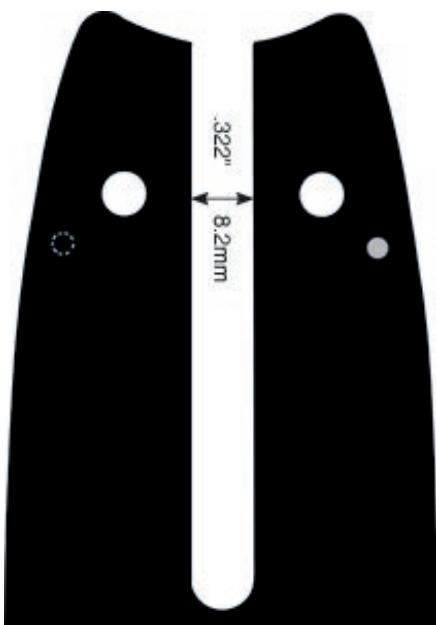

BLUEBIRD	C2000W
PARTNER	1640, 1840, ES2200
McCULLOCH	330, 335, 340
STIHL	009, 009L, 010, 011, 012, 015, 017, 018, 018C, 019, 019t, 020, 020T, 021, 023, 023C, 023L, 025, 025C, E 10, E 14, E 140, E 180, E 180C, MS 170, MS 191T, MS 192T, MS 200T, MS 210, MS 210C, MS 250, MS 250C, MSE 140, MSE 180C; STIHL Pole Pruners: Ht70, Ht75, Ht100, Ht101
ALPINA	361, 391

\* Compatible con Oregon A074

## PIÑÓN BARRA LAMINADA Y SOLIDA CON PUNTERA



REFERENCIA	TAMAÑO / PASO	REMACHES	MODELO	P.V.P SIN I.V.A.
501851001	Piñón 10T 325 1,5 mm EM		Partner • Husqvarna • Jonsered McCulloch • Oregon	27,19
501851005	Piñón 10T 325 1,3 mm EM		Partner • Husqvarna • Jonsered McCulloch • Oregon	27,19
TC101729	Puntera 3/8 1,5 mm	5R	Partner • Husqvarna • Jonsered McCulloch • Oregon	9,95
TC101730	Puntera 325 1,5 mm	5R	Partner • Husqvarna • Jonsered McCulloch • Oregon	10,95
TC900021	Pistola engrasadora piñones EM		Partner • Husqvarna • Jonsered McCulloch • Oregon	6,75
503621201	Grasa especial piñones barras EM		Partner • Husqvarna • Jonsered McCulloch • Oregon	3,90
PB453219	Pistola de engrase 100ml		Partner • Husqvarna • Jonsered McCulloch • Oregon	8,69



## CADENAS CORTADAS CAMON



REFERENCIA	TAMAÑO / PASO	Nº GUÍAS	MODELO	P.V.P SIN I.V.A.
A1758-15	1/4" PicoMicro 0,43" 1,1mm	28E	A1758 / A1758EO	8,85
TC202010	1/4" PicoMicro 0,43" 1,1mm	29E	CS2204/GA10010	8,95
CS22-06-CHAIN	1/4" PicoMicro 0,43" 1,1mm	34E	CS22-06	9,95
3020721010000	1/4" PicoMicro 0,43" 1,1mm	38E	GA10025/PCS22-06	12,95
L2108-14	1/4" PicoMicro 0,43" 1,1mm	47E	L2108 / A1828	13,97
3020710004200	1/4" PicoMicro 0,43" 1,1mm	48E	GA20025/PCS22-10	16,98
T23P056X	1/4" Micro 0,43" 1,1mm	56E	XCS2500TC	15,95
TC202013	1/4" PicoMicro 0,43" 1,1mm	60E	MCV3101TS-Q	16,25
T23P064X	1/4" Micro 0,43" 1,1mm	64E	XCS2500C	16,95
TC3251151	325" Mini 0,43" 1,1mm	51E	HUSQVARNA/SP21G	18,95
25AP058DL	1/4" 1,3 mm 0,50"	58E	OTRAS MARCAS	18,75
25AP060DL	1/4" 1,3 mm 0,50"	60E	C26PRO / TCS2600PRO	17,95
TC101614	3/8LP 1,1 mm 0,43"	40E		10,90
TC101644	3/8LP 1,1 mm 0,43"	44E		12,35
TC101764	3/8LP 1,1 mm 0,43"	50E		13,75
TC201915	3/8 LP 1,3 mm 0,50"	39E	GJD330/QJB270	9,55
TC201617	3/8LP 1,3 mm 0,50"	40E	TCS2600/MCV3100TS MCV3101TS	8,95
TC101761	3/8LP 1,3 mm 0,50"	42E		10,45
TC201916	3/8 LP 1,3 mm 0,50"	44E		11,25
TC201918	3/8LP 1,3 mm 0,50"	45E	MCV331T/P33/MCV3900	11,75
TC101762	3/8LP 1,3 mm 0,50"	46E		11,85
TC101620	3/8LP 1,3 mm 0,50"	49E		11,95
TC201621	3/8LP 1,3 mm 0,50"	50E		12,75
TC201919	3/8LP 1,3 mm 0,50"	52E	MCV3101S/MCV4000 352/370/MCV3100S/GT9302	13,25
TC201920	3/8LP 1,3 mm 0,50"	55E	1640/1840/ES200 C2000W	13,90
TC201921	3/8LP 1,3 mm 0,50"	56E	1550/1750/1850 1950/370/401/422	13,95
TC201922	3/8LP 1,3 mm 0,50"	57E	C37/C41/TCS4100 MCV381/MCV3501S	14,15
TC101629	3/8LP 1,3 mm 0,50"	60E		14,35
TC201923	3/8LP 1,3 mm 0,50"	62E	420/Formula 5000/842	14,75
TC201868	325 1,3 mm 0,50" R	64E	MCV4200S/410/411/4200	14,95
TC201869	325 1,3 mm 0,50" R	66E		15,95
TC101909	325 1,3 mm 0,50" R	68E		17,35
TC201870	325 1,3 mm 0,50" R	72E	461/470/510/511/540 543/4600/5000/5200	17,95
TC201882	325 1,5 mm 0,58" R	64E	360/400/405/450	14,95
TC201883	325 1,5 mm 0,58" R	66E		15,95
TC201910	325 1,5 mm 0,58" R	68E		17,35
TC201884	325 1,5 mm 0,58" C	72E	C45/C50/TCS4600/TCS5000 MCV5100S/MCV5600	17,95
TC201878	3/8 1,3 mm 0,50" R	68E		19,75
TC201911	3/8 1,3 mm 0,50" R	72E	C62/TCS6200	19,95
TC201742	3/8 1,5 mm 0,58" R	64E	S-50/S-55/S-65 550/650/7000/P70	16,95
TC201891	3/8 1,5 mm 0,58" R	66E	-	15,75
TC201802	3/8 1,5 mm 0,58" C	66D		18,75
TC201892	3/8 1,5 mm 0,58" R	68E	660/710/7700	17,75
TC201806	3/8 1,5 mm 0,58" C	68E	660/710/7700 Chisel (Diente cuadrado)	17,95
TC201760	3/8 1,5 mm 0,58" R	72E	MCV6200	19,90

\* R: diente redondo  
C: diente cuadrado

## ROLLOS DE CADENA CAMON



REFERENCIA	PASO / CANAL	Nº GUÍAS	TIPO DE CADENA / DIENTE	P.V.P SIN I.V.A.
TC144325	1/4" mini 1,1 mm 0,43"	600	Picco Micro	159,75
TC201900	1/4" mini 1,1 mm 0,43"	2400	Picco Micro	490,00
TC201930	1/4" 1,3 mm 0,50"	2392	Semi Chisel	535,00
TC201601	3/8LP 1,1 mm 0,43"	1640	Semi Chisel	287,00
TC201602	3/8LP 1,3 mm 0,50"	1640	Semi Chisel	287,00
TC201924	3/8LP 1,3 mm 0,50"	1640	Semi Chisel doble guía	287,00
TC201777	325 1,3 mm 0,50"	1848	Semi Chisel doble guía	326,00
TC201771	325 1,3 mm 0,50"	1848	Chisel doble guía	343,00
TC201778	325 1,5 mm 0,58"	1848	Semi Chisel doble guía	326,00
TC101772	325 1,5 mm 0,58"	1848	Chisel	343,00
TC201779	325 1,6 mm 0,63"	1848	Semi Chisel doble guía	326,00
TC201774	3/8 1,3 mm 0,50"	1640	Semi Chisel doble guía	326,00
TC201775	3/8 1,5 mm 0,58"	1640	Semi Chisel doble guía	326,00
TC201770	3/8 1,5 mm 0,58"	1640	Semi Chisel	326,00
TC201769	3/8 1,5 mm 0,58"	1640	Chisel doble guía	343,00
TC201776	3/8 1,6 mm 0,63"	1640	Semi Chisel doble guía	343,00
TC201598	404 1,6 mm 0,63"	1484	Semi Chisel	343,00

\* Chisel: cuadrado / Semichisel: redondo

## ROLLO DE CADENA CAMON TITANIUM



TI14M1125	1/4" Mini 0,43"/1,1mm	600	Redondo / Titanium	210,19
TI141125	1/4" 0,43"/1,1mm	600	Redondo / Titanium	196,67
TI381325	3/8LP 0,50"/1,3mm	410	Redondo / Titanium	95,87
TI3251325	0,325" 0,50"/1,3mm	562	Redondo / Titanium	106,67
TI381525	3/8" 0,50"/1,3mm	410	Redondo / Titanium	106,67

## ACCESORIOS ROLLO DE CADENA



REFERENCIA	TAMAÑO / PASO	P.V.P SIN I.V.A.
TC202020	Bolsa 20 ud. cinta 1/4" - PicoMicro	5,30
TC202030	Bolsa 20 ud. remache 1/4" - PicoMicro	4,90
TC101510	Bolsa 20 ud. cinta 3/8LP	4,90
TC101512	Bolsa 20 ud. remache 3/8LP	4,90
TC101517	Bolsa 20 ud. cinta 325	4,90
TC101518	Bolsa 20 ud. remache 325	4,90
TC101513	Bolsa 20 ud. cinta 3/8	4,90
TC101514	Bolsa 20 ud. remache 3/8	4,90
CA43044	Bolsa 20 ud. cinta 1/4	4,90
CA43045	Bolsa 20 ud. remache 1/4	4,90
CA82508	1. Soporte rollos cadena	59,00
TC101531	2. Rompedor cadena	69,75
TC101538	3. Remachador cadena	69,75
TC101532	4. Punzón rompedor 1/4" PicoMicro 0,43"	7,95
TC101539	6. Prisma remachador 1/4" PicoMicro 0,43"	9,95
TC101533	4. Punzón rompedor 1/4" 3/8LP 325"	5,40
TC101534	4. Punzón rompedor 3/8" 404"	5,40
TC101541	5. Prisma remachar 325" 1/4" 3/8 LP	4,75
TC101540	6. Prisma remachar 3/8" 404"	4,75
TC101535	7. Yunque	17,95
PB453986	8. Yunque ajustable	13,95
TC000403	9. Kit rompedor + Remachador universal	151,00

**ACCESORIOS DE LIMADO**

REFERENCIA	DESCRIPCIÓN	MODELO	P.V.P. SIN I.V.A.	
 (Caja 12 Unidades)	TC101190	Lima redonda 3,2 mm 1/4"	Paso 1/4"	1,50
	TC101191	Lima redonda 4,0 mm 5/32"	Paso 3/8LP	1,59
	TC101192	Lima redonda 4,8 mm 3/16"	Paso 325"	1,59
	TC101197	Lima redonda 5,2 mm 13/64"	Paso 3/8"	1,69
	TC101193	Lima redonda 5,5 mm 7/32"	Paso 3/8"	1,69
	TC101194	Lima plana 150 mm 6"	(Caja 12 Unidades)	3,50
 (6)	TC040300	6. Mango lima redonda/plana EM	Camon · Partner Husqvarna · Jonsered	2,95
(7) 	CA93004	7. Mango de madera lima redonda	Universal	1,69
 (8)  (9)	PB453910	8. Mango de plastico lima redonda	Universal 88mm	0,99
(10) 	TC101195	9. Mango lima redonda	Camon	1,59
(10A) 	PB453963	10. Portalimas guía afilado		9,20
	PB453931	10A. Limitador de profundidad	Universal	4,95
(11) 	PB453911	11. Afilador universal (sin lima)	Lima Ø 4 mm	20,95
(12) 	PB453917	12. Afilador universal (sin lima)	Lima Ø 4-5,5 mm	26,95
(13) 	G015	13. Soporte afilado en tronco		15,75
(14) 	PB455145	14. Afiladora de cadenas eléctrica	220V 85W 4800 r.p.m.	51,90
(17) 	PB455147	17. Piedra de afilar 108x3,2x23	Para PB455145	7,85
	PB455197	17. Piedra de afilar 108x4,5x10	Ø 10 mm	10,75
(15) 	PB10909008	15. Soporte afilado con trinquete		19,95
(16) 	PB015454	16. Afiladora Cadenas 12V	85W 2.500 r.p.m.	27,95
(18) 	G060	18. Rodillo de afilar (5 uds.) 5/32	Para PB015454	10,90
	G061	18. Rodillo de afilar (5 uds.) 3/16	Para PB015454	10,90
	G062	18. Rodillo de afilar (5 uds.) 7/32	Para PB015454	10,90
(19) 	PB000007	19. Piedra de afilar cuchillas	2" para taladro	5,45

## ACCESORIOS DE LIMADO ADAPTABLES



REFERENCIA	DESCRIPCIÓN	MODELO	P.V.P SIN I.V.A.
PB204033	(1) Piedra afilar 145x2,9x22,2 mm	Cadena Widia	23,95
PB204034	(1) Piedra afilar 145x4,5x22,2 mm	Cadena Widia	23,95
TC101544	(2) Maquina afilar cadenas 220V	2.800 RPM / 230 W	139,75
TC101546	(3) Piedra afilar 145x22,2x3,2 mm	325", 1/4" 3/8 LP	18,90
TC101545	(3) Piedra afilar 145x22,2x4,7 mm	3/8", 404"	18,90
TC101543	(3) Piedra afilar 145x22,2x6,2 mm	Piedra guía cadenas	21,95
PB150616	(4) Muelle brazo afiladora		3,95
PB135169	(5) Tope afiladora cadenas		6,90
PB015147	(6) Piedra limpieza 55x15x5		7,15
PB9308314	(7) Kit limado 1/4"y 3/8lp		9,95
PB9308315	(7) Kit limado 325		9,95
PB9308312	(7) Kit de limado 1/4"/3/8lp/325/3/8"/404"/		14,75

## CILINDROS Y PISTONES MOTOSIERRAS ADAPTABLES ZENOAH / CAMON



C26-001	Cilindro		21,75
C26-008	Pistón ø 34 mm (1 ARO)		10,00
C26-009	Segmento Pistón	CAMON: C26 C26 Pro TCS2600	3,90
C26-010	Bulón Pistón 17x8		1,95
C26-011	Clip Bulón Pistón	ZENOAH G2500	0,60
C26-012	Rodamiento Biela-Pistón 8x11x9		3,95
C37-ZJA001	Cilindro		26,00
C37-ZJA005	Junta cilindro		1,35
C37-ZJA028	Pistón ø 39 mm (1 ARO)		15,00
C37-ZJA029	Segmento Pistón	CAMON: C37 ZENOAH G3800	3,90
C37-ZJA030	Bulón Pistón 17,5x10		1,95
C37-ZJA031	Clip Bulón Pistón		0,39
C37-ZJA032	Rodamiento Biela-Pistón 12x17x10		3,95
C41-ZJB001	Cilindro		29,00
C37-ZJA005	Junta cilindro		1,35
C41-ZJB017	Pistón 40,5 mm (1 aro)		17,00
C41-ZJB014	Segmento Pistón	CAMON: C41 TCS4100	2,36
C37-ZJA030	Bulón Pistón 17,5x10	ZENOAH G3800	1,95
C37-ZJA031	Clip Bulón Pistón		0,39
C37-ZJA032	Rodamiento Biela-Pistón 10x14x11		3,95

## CILINDROS Y PISTONES MOTOSIERRAS ADAPTABLES ZENOAH / CAMON



REFERENCIA	DESCRIPCIÓN	MODELO	P.V.P SIN I.V.A.
C45-ZJB001	Cilindro	CAMON: C45 TCS4600  ZENOAH: G455	33,71
C45-ZJB016	Junta cilindro		1,25
C45-ZJB018	Pistón ø 43 mm (2 aros)		16,00
C45-ZJB017	Segmento Pistón		2,36
C45-ZJB020	Bulón Pistón 34x11		1,95
C45-ZJB019	Clip Bulón Pistón		0,68
C45-ZJB023	Rodamiento Biela-Pistón 11x15x12,5		3,95
C50-B001	Cilindro		CAMON C50 TCS5000  ZENOAH: G500
C45-ZJB016	Junta cilindro	1,25	
C50-B018	Pistón ø 45 mm (2 aros)	17,00	
C50-B017	Segmento Pistón	3,90	
C50-B020	Bulón Pistón 37x11	2,11	
C45-ZJB019	Clip Bulón Pistón	0,69	
C45-ZJB023	Rodamiento Biela-Pistón 11x15x12,5	3,95	
C62-A009	Cilindro	CAMON C62 / TCS6200 ZENOAH: G621	
C62-A036	Junta cilindro		1,25
C62-A038	Pistón ø 47 mm (2 aros)		17,26
C62-A037	Segmento Pistón		2,93
C62-A039	Bulón Pistón 40x11		2,14
C45-ZJB019	Clip Bulón Pistón		0,69
C45-ZJB023	Rodamiento Biela-Pistón 11x15x12,5		3,95
ZJA045	Cilindro		GJB-25D
ZJA039	Junta cilindro	1,10	
ZJA060	Pistón CPL (2 Aros)	12,00	

## CILINDRO + PISTÓN ADAPTABLES



REFERENCIA	DESCRIPCIÓN / MODELOS	MM	REF. ORIGIN.	P.V.P SIN I.V.A.
PB11101B	1. Zenoah: 2500	34 mm	25 cc	56,00
PB11106A	2. Zenoah: 5200 / GA455 / GA500 / TCS4600	45 mm	50 cc	59,00
G141	Poulan 2250/2450/2550 Partner: 351/352/370/401/420/422	38 mm	McCulloch Poulan	59,75
G140	Poulan 2250/2450/2550 Partner: 351/352/370/401/420/422	41 mm	McCulloch Poulan	41,75
G115	Husqvarna: 435/440	41 mm	504735101	65,00
G1530	Husqvarna: 141 / 142	40 mm	530069941	29,00
G1531	Husqvarna: 235 / 236 / 240	39 mm	574291001	49,00
G1532	Husqvarna: 345	42 mm	503870276	49,00
G1533	Husqvarna: 445 / 450 · Jonsered: 2245	42 mm	544119902	89,00
G1534	Husqvarna: 455 / Jonsered: 2255	47 mm	537320402	79,75
G121	Husqvarna 350/351/353/340/345/346 Jonsered 2149/2150/2153	44 mm	503869971	59,00
G122	Husqvarna 357/359, Jonsered 2156	47 mm	537157304	50,00
G123	Husqvarna 340/345/350, Jonsered 2141	40 mm	503870005	50,00
G119	Husqvarna 372 XP/362/365/371/375 Jonsered 2165/2171	52 mm	503626473	72,00
G125	Husqvarna 50/51	45 mm	503168301	59,00
G126	Husqvarna 50/51/55 / Partner 540/543	46 mm	503609171	59,00
G127	Husqvarna 61/66 Jonsered 630	48 mm	544222802	49,00

## CILINDRO + PISTÓN ADAPTABLES

REFERENCIA	DESCRIPCIÓN	MM	REF. ORIGIN.	P.V.P SIN I.V.A.
G128	Husqvarna 365 · Jonsered 2165	48 mm	503939005	56,00
G129	Husqvarna 371/372 · Jonsered 2171 (2 Aros)	50 mm	503939372	59,00
G130	Husqvarna 268 · Jonsered 670	50 mm	544222902	65,00
G131	Husqvarna 281/288/181	54 mm	503907401	69,00
G132	Husqvarna 272/272K/272XP/272S	52 mm	503609671	59,00
G133	Husqvarna 395	56 mm	503993971	72,00
G134	Alpina 450/500 - Castor 52 / Start 55	45 mm	854-0970	76,00
G1547	Oled Mac: 440/740/8400/8405	40 mm	74000280	49,00
G118	Husqvarna 235/236/240E Jonsered 2238	39 mm	574291001	76,90
G138	Partner K650 Active	50 mm	506099212	69,00
G139	Partner K1250 Active	60 mm	506294271	86,00
G160	Partner K750/K760	51 mm	581476103	89,00
G1540	Stihl FS55	35 mm	-	36,00
G1541	Stihl FS400	40 mm	41280201201	52,00
G1542	Stihl FS450	42 mm	41280201211	55,00
G1543	Stihl FS480	44 mm	41280201202	59,00
G144	Stihl 017-MS170	37 mm	11300201207	39,00
G145	Stihl 018-MS180 (bulón Ø10mm)	38 mm	11300201205	39,75
G146	Stihl 023-MS230	40 mm	11230201214	39,00
G1536	Stihl MS211	40 mm	11390201202	69,75
G147	Stihl 025-MS250	42 mm	11230201206	39,00
G1537	Stihl MS251	44 mm	11430201207	69,75
G148	Stihl 026-MS260	44 mm	11210201203	59,00
G1538	Stihl MS362	47 mm	11400201200	69,75
G149	Stihl 039-MS390	49 mm	11270201213	59,00
G150	Stihl 029-MS290	46 mm	11270201217	49,00
G1535	Stihl MS361	47 mm	11350201202	49,00
G151	Stihl 034-036-MS360	48 mm	11250201215	49,00
G152	Stihl 044-MS440 (bulón Ø12mm)	50 mm	11280201227	49,00
G1539	Stihl MS461	52 mm	-	69,75
G153	Stihl 046-MS460	52 mm	11280201217	59,00
G154	Stihl 066-MS660 / 064 / MS640	54 mm	11220201211	59,75
G155	Kawasaki TH-48	44 mm	11005-2123	59,90
G156	Kawasaki TH-43	41,5 mm	11005-2122	71,00
G1545	Kawasaki TJ45E	42,5 mm	11005-2159	73,90
G1546	Kawasaki TJ53E	44 mm	11005-2166	73,90
G1544	Chinas 41cc / C41 / TCS4100	40,5 mm	-	29,95
SH111114	CG430/CG15Q43	40 mm		40,75
SH111115	3WT-300/GC415Q52	44 mm		49,75
SH111116	EB800-E	53 mm		53,75
G157	Válvula Descompresión Husqvarna · Jonsered		503715301	7,90
G158	Válvula Descompresión Stihl		11280209400	6,90
PB990067	Tornillo cilindro descompresión M10X100		503552201 Husqvarna / Jonsered Partner / McCulloch	2,50



## SILENCIOSOS ADAPTABLES



REFERENCIA	DESCRIPCIÓN	P.V.P SIN I.V.A.
<b>G425</b>	1. Silencioso WM500 / WM1000 / Honda GX160	16,90
<b>C26-023</b>	2. Silencioso C26 / C26 Pro / TCS2600 / Zenoah G2500	16,75
<b>C37-ZJA007</b>	3. Silencioso C37 / C41 / TCS4100 / Zenoah G3800	11,90
<b>C45-ZJB006</b>	4. Silencioso C45 / C50 / TCS4600 / TCS5000 / Zenoah G455/500	18,95
<b>C62-A005</b>	5. Silencioso C62 / Zenoah G621 / TCS6200	29,75
<b>ZJA041</b>	6. Silencioso GJB25D	18,90
<b>SH2320025459</b>	Silencioso SG250	13,00
<b>SH2320035586</b>	Silencioso CG260E	17,90
<b>SH2320026963</b>	Silencioso CG330E	17,95
<b>SH2320026965</b>	10. Silencioso CG430E / BG520A / 3GC520	19,90
<b>SH2320056069</b>	11. Silencioso EB800E	27,75
<b>BS790828</b>	12. Silencioso Briggs&Stratton	39,90
<b>PB990070</b>	13. Silencioso 503917601 Husqvarna 355 / 357 / 359 · Jonsered 2156 / 2159	29,95
<b>PB990069</b>	14. Silencioso 501816801 Husqvarna 281 / 288	39,75
<b>PB990068</b>	15. Silencioso 545180843 Husqvarna 236 / 240 · Jonsered 2234 / 2238	39,00
<b>G426</b>	Silencioso 501766605 Husqvarna 50 / 51 / 55 / 154 / 254	29,75
<b>G427</b>	17. Silencioso 530069415 Husqvarna 36 / 41 / 136 / 141 / 142	28,95
<b>G428</b>	18. Silencioso 501766605 Husqvarna 61 / 66 / 266 / 268 / 272 · Jonsered 630 / 670	22,75
<b>G429</b>	19. Silencioso 544028401 Husqvarna 340 / 340E / 345 · Jonsered 2141 / 2145	19,75
<b>G430</b>	20. Silencioso 544029702 Husqv. 362 / 365 / 371 / 372 / 385 · Jonsered 2165 / 2171 / 2065	29,75
<b>G921</b>	21. Silencioso 530071904 Partner 351 / 352 / 370 / 420 / 401 / 422 · McCulloch 335 / 435 / 440	29,75
<b>PB990071</b>	22. Silencioso 544147702 Husqvarna 135 / 140 / 435 / 440 / 445 / 450	33,95
<b>A25.2105.0100</b>	23. Silencioso XCS2500C/TC	23,90

**TAPAS DE CADENA CPL ADAPTABLES**

	REFERENCIA	DESCRIPCIÓN	MODELO	P.V.P SIN I.V.A.
(1) 	<b>TCS2600-69</b>	1. Tapa cadena completa	CAMON: TCS2600 / G2500 ZENOAH: G2500	20,95
(2) 	<b>TCS4100A-1</b>	2. Tapa cadena completa	CAMON: TCS4100 / G3800 ZENOAH: G3800	23,75
	<b>TCS4600A-1</b>	2. Tapa cadena completa	CAMON: TCS4600 / TCS5000 ZENOAH: G455 / G500	26,90
(4) 	<b>C37-ZJB037A</b>	Tapa cadena CPL	CAMON: C37 / C41 ZENOAH: G3800	21,90
	<b>C45-ZJA001</b>	Tapa cadena CPL	CAMON: C45 ZENOAH: G455	26,90
(5) 	<b>TCS6200-65</b>	5. Tapa cadena (sola)	TCS6200	6,95
(6) 	<b>C62-B067</b>	5. Tapa cadena	CAMON: C62 ZENOAH: G621	12,90
(7) 	<b>G950</b>	6. Tapa cadena CPL Partner EM Ref. 545139901	350/351/351XT/352/370/420	29,95
	<b>C37-ZJB037</b>	7. Tapa cadena sola	CAMON: C37/C41 ZENOAH: G3800	5,95
(8) 	<b>G940</b>	8. Tapa cadena sola Husqvarna Ref. 537033501	365 / 372	26,90
(9) 	<b>G941</b>	9. Tapa cadena sola Husqvarna Ref. 537107801	340 / 345 / 350 / 351 / 357	39,95
(10) 	<b>G942</b>	10. Tapa de cadena CPL Husqv. Ref. 503736601	61 / 268 / 272	34,90
(11) 	<b>G943</b>	11. Tapa de cadena sola Stihl Ref. 11256401701	038 / MS380 / MS381	19,95
(12) 	<b>PB990079</b>	12. Tapa de cadena Husqvarna Ref. 503731503	394 / 395	59,95
(13) 	<b>PB037110</b>	13. Tapa de cadena Husqvarna Ref. 530054802	136/137/141/142	21,95



## TENSORES DE CADENA MOTOSIERRAS CAMON Y ADAPTABLES

	REFERENCIA	DESCRIPCIÓN	MODELO	2,53P.V.P SIN I.V.A.
	<b>C26-142</b>	1. Tornillo tensor	G2500 / C26 / C26 Pro / TCS2600	1,90
	<b>C26-143</b>	2. Pivote tensor	G2500 / C26 / C26 Pro / TCS2600	1,90
	<b>C45-ZJA029</b>	3. Piñón Tensor	G2500 / C26 / C26 Pro / TCS2600	1,95
	<b>C45-ZJA012</b>	4. Tornillo tensor	G3800 / G455 / G500 TCS4100 / TCS4600 / TCS5000 C45 / C50	1,90
	<b>C45-ZJA013</b>	5. Pivote tensor	G3800 / G455 / G500 TCS4100 / TCS4600 / TCS5000 C45 / C50	1,90
	<b>C45-ZJA029</b>	3. Piñón tensor	G3800 / G455 / G500 TCS4100 / TCS4600 / TCS5000 C45 / C50	1,90
	<b>C50-A007</b>	6. Tornillo tensor frontal	C45 / C50	2,50
	<b>C50-A006</b>	7. Pivote tensor frontal	C45 / C50	1,90
	<b>C45-ZJA075</b>	8. Clip tensor frontal	C45 / C50	0,59
	<b>PB457168</b>	9. Tornillo tensor CPL Ref. 501537101	Jonsered: 629/630/670 • Husqvarna: 51/61 66/162/181/266/268/272/281/288 Partner: 660/710/7700	2,90
	<b>PB990016</b>	10. Tornillo tensor CPL Partner Ref. 530069611	Partner: 350 / 351 / 352 / 370 / 420 Husqvarna: 137 / 236 / 136 / 235 McCulloch: Mac335 / 738 / 756 / 742 / 435	3,75
	<b>PB457169</b>	11. Tornillo tensor CPL Husq. Ref.501546301	51 / 55 / 238 / 242	2,75
	<b>PB000009</b>	12. Tornillo tensor CPL Husq. Ref. 537044102	362 / 365 / 372 / 570 / 575 / 576 2163 / 2165 / 2171	6,90
	<b>PB000001</b>	13. Tornillo tensor CPL Stihl Ref. 11206641500	021/023/025/MS210/230/250/340	2,75
	<b>PB000004</b>	14. Tornillo tensor CPL Stihl Ref.11250071021	024 / 026 / 028 / 054 / MS260 MS261 / MS270 / MS280	13,79
	<b>PB000005</b>	15. Tornillo tensor CPL Stihl Ref. 11066641500	050 / 051 / 070 / 075 / 076	3,65
	<b>PB371101</b>	17. Tornillo tensor CPL Zenoah	Oleo Mac / Zenoah / Efco Husqvarna / Jonsered	2,53
	<b>PB371103</b>	18. Tornillo tensor CPL Zenoah	4500 / 5200 / 5000	2,53
	<b>PB371103A</b>	19. Tornillo tensor CPL Zenoah	4500 / 5200 / 5000	2,53

**CHAPAS DE ENGRASE MOTOSIERRAS CAMON Y ADAPTABLES**

	REFERENCIA	DESCRIPCIÓN	MODELO	P.V.P SIN I.V.A.
 (1)	<b>PB6406676</b>	1. Tuerca barra M6x1,00	Echo / Alpina / OleoMac	1,69
 (1A)	<b>C37-ZJB059</b>	1. Tuerca barra M8x1,25	C26/C37/C41/C45/C50/C37/C41/C45/C50 C62/TCS2600/TCS4100/TCS4600/TCS5000	0,69
 (2) (3)	<b>PB990005</b>	1. Tuerca barra (10 unidades)	M8x1.25mm	4,98
 (1A)	<b>PB000095</b>	1A. Tuerca barra	Sthil 00009550801	0,75
 (4) (5)	<b>C26-106</b>	2. Chapa engrase interior	C26/C26PRO/TCS2600	2,90
 (4) (5)	<b>C26-141</b>	3. Chapa engrase exterior	C26/C26PRO/TCS2600	2,95
 (6) (7)	<b>C37-ZJA026</b>	4. Chapa engrase interior	C37/C41/TCS4100	2,90
 (6) (7)	<b>C45-ZJB099</b>	5. Chapa engrase interior	C45/C50/TCS4600/TCS5000	2,90
 (6) (7)	<b>C45-ZJA020</b>	6. Chapa engrase exterior	C41/C45/C50/TCS4600/TCS5000	2,90
 (8) (9)	<b>C62-B063</b>	7. Chapa engrase interior	C62 / TCS2600	3,10
 (8) (9)	<b>C62-B066</b>	8. Chapa engrase exterior	C62 / TCS2600	3,10
 (10) (11)	<b>P530047855</b>	9. Chapa de engrase	Husqvarna 36/41/137/141/142	4,95
 (10) (11)	<b>P503152101</b>	10. Chapa de engrase	Husqvarna 50/51/55	3,95
 (12) (13)	<b>A25.2100.0022</b>	11. Chapa engrase interior	XCS2500C/TC	3,59
 (12) (13)	<b>P501444501</b>	12. Chapa de engrase exterior	Husqvarna 61/66/266/268/272	5,95
 (14) (15)	<b>P503856601</b>	14. Chapa de engrase exterior	Husqvarna 340/345/346/350 351/353/357/359	5,50
 (14) (15)	<b>A27.0112.0009</b>	13. Chapa de engrase exterior	XCS2500C/TC	4,86
 (16) (17)	<b>P537046601</b>	15. Chapa de engrase	Husqvarna 362/365/371/372/385/390	6,95
 (16) (17)	<b>P501517201</b>	16. Tope guía tapa cadena	Husqvarna 61/66/261/266/268/272/372	1,95
 (16) (17)	<b>P530038238</b>	17. Chapa de engrase	Partner 351/352/370/420	6,90





**BOBINAS Y ELECTRÓNICOS ADAPTABLES**

	REFERENCIA	DESCRIPCIÓN	MODELO	P.V.P SIN I.V.A.
(1) 	<b>C26-033</b>	1. Bobina	Camon: C26/C26 PRO/TCS2600 Zenoah: G2500	20,75
(2) 	<b>C37-ZJA065</b>	2. Bobina	Camon: C37/C41/TCS4100 Zenoah: G3800	21,75
	<b>C45-ZJB095</b>	3. Bobina	Camon: C45/C50/TCS4600/TCS5000 Zenoah: G455 / G500	22,75
	<b>C62-A029</b>	4. Electrónico	Camon: C62 • Zenoah: G621 / 6200	14,95
(3) 	<b>C62-A028</b>	5. Bobina	Camon: C62 • Zenoah: G621	19,95
(4) 	<b>ZJA031</b>	6. Bobina	Camon: GJB-25D	17,95
	<b>SH2320031284</b>	Bobina	Camon: CG260E	29,75
(5) 	<b>SH2320027088</b>	Bobina	Camon: CG330-E	29,75
(6) 	<b>SH2320037468</b>	9. Bobina	Camon: CG430-E	29,75
	<b>SH2320099084</b>	10. Bobina	Camon: 3GC430/3GC520	27,90
(9) 	<b>SH2320006439</b>	Bobina	Camon: BG431	29,75
(10) 	<b>SH2320067802</b>	Bobina	Camon: BG520A	22,95
	<b>SH2320073261</b>	Bobina	Camon: QJB270	23,90
(15) 	<b>SH2320050183</b>	Bobina	Camon: EB800-E	22,95
(16) 	<b>SH2320034496</b>	Bobina	Camon: EBV260E	20,95
	<b>PB490028</b>	15. Bobina Ref. 411000158	Echo: CS300 / 301 / 303 / 306 / 341 / 345 / 350	29,75
(17) 	<b>G178</b>	16. Bobina. Ref. 537162204, 510115701	Husquvarna: 340/345/346/350/351/353/357 359/362/365/371/371i2/385/390	24,90
	<b>G174</b>	17. Bobina Ref.530039198	Partner: 350/351/370/352/401/420/422 Poulan: 2050/2150/2250/2450/2550	21,95
(18) 	<b>SH777777</b>	18. Plato magnético	Camon CG430/3GC430/3GC520 CG415Q43	11,25

**BOBINAS Y ELECTRÓNICOS ADAPTABLES**

REFERENCIA	DESCRIPCIÓN	MODELO	P.V.P SIN I.V.A.
 (23) <b>PB031234</b>	21. Bobina Ref.544018801	K650 Active / K700 Active K950 Active / K1250 Active	49,75
<b>PB490029</b>	22. Bobina Ref.544047502	Partner: K750 / K760 / K850	50,90
<b>G169</b>	23. Bobina Ref.503639801	Husqvarna 394 / 394XP / 395 / 395XP	49,90
 (24) <b>G182</b>	24. Bobina Ref.544018401	Partner: 543/660/K1200 · Husqvarna 61/268/272 Jonsered 2041/2045/2050	26,90
<b>G170</b>	25. Bobina Ref.573935702	Husqvarna: 435/435E/440E/445/450 Jonsered: 2240 / 2245 / 2250	32,75
 (25) <b>G171</b>	Bobina Ref.501001301	Husqvarna: 343R / 343FR / 345R / 345RX	49,95
<b>G184</b>	Bobina Ref. 537038501	Husqvarna: 232R/235R/235RII	39,95
<b>G177</b>	29. Bobina Ref. 544018301	Husqvarna: 45/51/55/61/240R/245R/250R/252R Partner: 500/540/550/650/7000/B405/B450/B380	26,95
 (21) <b>G172</b>	Bobina Ref.575803501	Husqvarna: 235E / 236E / 240E	29,75
<b>G179</b>	Bobina - Ref. 00004001300	Stihl: 024/026/028/034/038/MS290/MS390	23,75
<b>G180</b>	Bobina - Ref. 00004001306	Stihl: 021/023/025/MS210/MS230/MS250	21,90
 (22) <b>PB490023</b>	Bobina Ref. 41804001308	Stihl: FS87 / 90 / 100 / 110 / 130 HL95 / 100 KM90 / 100 / 130	29,75
<b>PB490024</b>	Bobina Ref.41284001306	Stihl: FS400 / 450 / 480	26,95
 (29) <b>PB490025</b>	Bobina Ref.42384001301	Stihl: TS410 / 420	49,75
<b>PB490026</b>	Bobina Ref.11224001314	Stihl: 046 / 066 / MS460 / 650 / 660	29,90
<b>PB490027</b>	Bobina Ref.11374001300	Stihl: MS192 / 192C / 192T	41,75
 (7) <b>PU0001180025</b>	Bobina	Loncin: LC170F	23,90
<b>PU0001200106</b>	Bobina	Mitsubishi GT400 / GT600	69,75
 (6) <b>G166</b>	6. AVR Monofásico	Regulador voltaje WM2500W	19,95
<b>G167</b>	7. AVR Monofásico	Regulador voltaje WM3500 / WM5500	28,90

**BOBINAS ADAPTABLES PARA MOTORES HONDA • BRIGGS STRATTON • TECUMSEH**

REFERENCIA	DESCRIPCIÓN	REFERENCIA ORIGINAL	PARA MOTORES	P.V.P SIN I.V.A. ADAPTABLE	P.V.P SIN I.V.A. ORIGINAL
 <b>PB455822</b>	Briggs & Stratton John Deere	397358	5 HP Horizontal y Vertical	39,75	56,90
 <b>PB455824</b>	Briggs & Stratton	796964	Quantum Europa 5HP 2 tiempos	39,75	53,00
 <b>PB455829</b>	Briggs & Stratton John Deere	591420	2 y 4 HP Horizontal y Vertical	39,75	47,00
 <b>PB455820</b>	Briggs & Stratton John Deere	398811	7 a 16 HP Horizontal y Vertical 1 cilindro	39,75	56,55

## BOBINAS ADAPTABLES



(1)



(2)

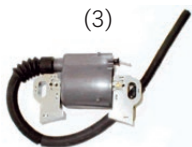

(3)



(4)



(5)



(6)



(7)



(8)



(9)

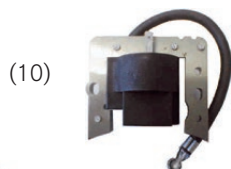

(10)



(12)

REFERENCIA	DESCRIPCIÓN	REFERENCIA ORIGINAL	PARA MOTORES	P.V.P SIN I.V.A.
G183	1. Kawasaki	21130-2056 27171 - 2192	Kawasaki TD40 / TD43 / TD48	27,90
PB456265	2. Honda	30500-ZE1-033 30500-ZE1-063 30500-ZE1-073	GX110, GX120 GX140, GX160	19,95
PB456266	3. Honda	30500-ZF6-W03 30500-ZE2-023	GX240, GX270 GX340, GX390	21,95
PB490014	4. Honda	30500-ZOH-003	GX25	14,90
PB490015	5. Honda	30500-ZM3-003	GX31	21,95
PB490016	6. Honda	30500-ZOZ-003	GX35	21,95
PB490017	7. Honda	30500-ZOD-013	GX100 / GX60	32,90
PB490018	8. Honda	30500-ZL8-014	GC135/ 160 GCV135 / 160 / 190	21,95
PB490019	9. Honda	30500-Z1V-013	GXV120 / 140 / 160	21,95
PB455819	10. Tecumseh	34443A 34443B 34443C 14160034	VANTAGE 35, LEV100, LEV115 LV148A, LEV120, H70 LV148A, LV195EA, AH600 OVRM105, OVRM120	49,00
PB490012	MTD	751-10792	MTD	21,90
PB490013	12. Kohler	1258405S	Kohler	39,75
PB490020	Robin / Subaru		EX13 / 17 / 21	23,75
PB490021	Robin / Subaru		EY20	23,75
PB490022	Robin / Subaru		EY28	23,75

## CABLE BOBINA



REFERENCIA	DESCRIPCIÓN	LONGITUD	DIÁMETRO	P.V.P SIN I.V.A.
PB453732	Cable bobina	5 m	ø 5 mm	10,20
PB453733	Cable bobina	5 m	ø 7 mm	19,75

**TAPAS PUESTA EN MARCHA ADAPTABLES**

REFERENCIA	DESCRIPCIÓN	MODELO	P.V.P SIN I.V.A.
TCS2600-140	1. Tapa P/M CPL Camon	Camon: TCS2600 • Zenoah: G2500	21,90
TCS4100 A-37	2. Tapa P/M CPL Camon	Camon: TCS4100 • Zenoah: G3800	24,95
TCS4600 A-36	3. Tapa P/M CPL Camon	Camon: TCS4600/TCS5000 • Zenoah: G455/500	22,90
C26-108	Tapa P/M CPL Camon	Camon: C26 - C26 Pro • Zenoah: G2500	19,95
C37-ZJB061	5. Tapa P/M CPL Camon	Camon: C37 • Zenoah: G3800	18,90
C41-ZJA038	6. Tapa P/M CPL Camon	Camon: C41 • Zenoah: G3800	19,95
C45-ZJA037	Tapa P/M CPL Camon	Camon: C45 • Zenoah: G455	19,95
C50-A034	8. Tapa P/M CPL Camon	Camon: C50 • Zenoah: G500	19,95
C62-B077	9. Tapa P/M CPL Camon	Camon: C62 • Zenoah: G621	22,95
ZJC056	10. Tapa P/M CPL Camon	GJB-25D	14,95
SH2320007383	Tapa P/M CPL Camon	BG431	21,90
SH2320085275	12. Tapa P/M CPL Camon	GJD330/CG330-E/CG430-E/QGZ25 3WT-300A	14,95
SH2320032329	13. Tapa P/M CPL	CG260 / EBV260	18,95
SH2320042961	14. Tapa P/M CPL	BG520A	15,90
SH2320033600	15. Tapa P/M CPL	QJB270	15,90
SH2320050090	16. Tapa P/M CPL	EB800-E	16,90
SH2320104018	17. Tapa P/M CPL	3GC430/3GC520	18,95
SH2320109655	18. Tapa P/MCPL	CG415Q33 / CG415Q43 / CG415Q52	16,95
SH2320072472	Tapa P/M CPL	3WZ-6F	18,75
G199	20. Tapa P/M CPL	Partner 350/351/352/370/420 • McC • Husq • Jon McC 335 / 435 / 440	16,95
G190	21. Tapa P/M CPL	Husqv. 357/359. Ref.503930603	29,72
G191	22. Tapa P/M CPL	Stihl 064/066/MS640/MS660. Ref.11220802110	32,00
G192	23. Tapa P/M CPL	Stihl 034/036/MS340/MS360. Ref.11250802105	29,00
G193	24. Tapa P/M CPL	Husqv. 61/261/266/268/272. Ref.503615571	24,00
G194	25. Tapa P/M CPL	Husqv. 50/51/55. Ref.503608803	21,90

## TAPAS PUESTA EN MARCHA ADAPTABLES

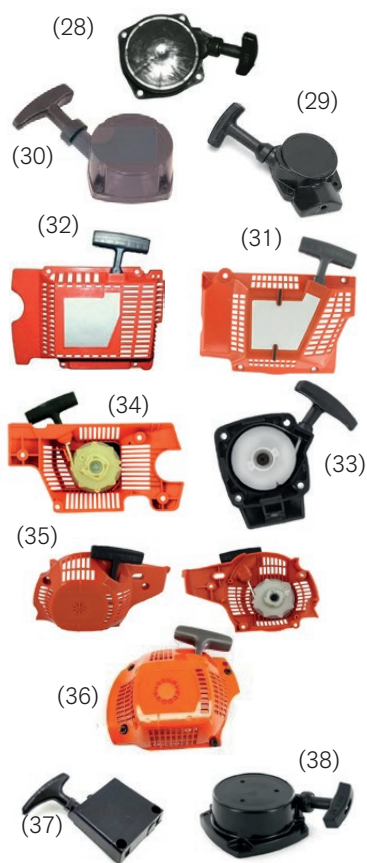

REFERENCIA	DESCRIPCIÓN	MODELO	P.V.P SIN I.V.A.
PB455072	28. Tapa P/M	Kawasaki: TD40 / TD43 / TD48 MITSUBISHI t200	33,90
PB69810241	29. Tapa P/M	Alpina / Castellgarden / Stiga / Mitsubishi	14,95
PB69811611	30. Tapa P/M	Alpina / Castellgarden / Stiga / Mitsubishi	29,90
G195	31. Tapa P/M CPL	Husqvarna 362/ 365/371/372. Ref.503628171	23,95
G196	32. Tapa P/M CPL	Husqv. 281/288. Ref.501810006	28,95
G186	Tapa P/M CPL	Husqv. 340/345/350. Ref. 537422901	31,95
PB990029	33. Tapa P/M CPL 527918101	Husqvarna: 226RJ	19,75
PB990030	34. Tapa P/M CPL 527918101	Husqvarna: 36 / 41 / 136 / 142 / 137	26,75
PB990031	35. Tapa P/M CPL 545008025	Husqvarna: 235 / 236 / 240	24,95
PB990032	36. Tapa P/M CPL 522012501	Husqvarna: T435 / 440 / 435	32,95
G211	Tapa P/M	Kawasaki TH34	32,95
G187	37. Tapa P/M CPL	Kawasaki TH43/TH48. Ref. 49088-2442	23,90
G188	38. Tapa P/M CPL	Alpina Star 45/55. Ref: 3830370000	49,75

## ARRANCADOR COMPLETO ADAPTABLE A MOTORES HONDA



REFERENCIA	DESCRIPCIÓN	REFERENCIA ORIGINAL	PARA MOTORES	P.V.P SIN I.V.A.
PB990025	Arrancador	28400-ZOH-003	GX24 / GX25	16,95
PB990028	Arranque fácil	28400-ZOH-014	GX35	15,90
PB456227	Arrancador 2 Trinquetes plástico	28400-ZH8-013ZA 28400-ZH8-003ZA	GX120 / GX140 GX160 / GX200	24,95
PB455104	Arrancador	28400-ZE3-W01ZA	GX340-GX390	28,90
PB454217	Arrancador 2 Trinquetes	28400-ZL8-003ZB 28400-ZE8-003ZB	GCV135, GC135, GCV160, GC160	21,95
PB455064	Arrancador 2 Trinquetes	28400-ZE2-W01ZA 28400-ZE2-W01ZN	GX240-GX270	28,90
PB455029	Arrancador	28410-Z1V-003ZB	GXV140-GXV160	36,90
PB454218	Arrancador 2 Trinquetes metálicos	28400-ZE1-003H 28400-ZE1-003ZA 28400-ZE1-013ZA	GX110 - GX120 GX140 - GX160 - GX200	26,90
PB455027	Arrancador	28400-ZM3-003	GX22, GX23-1BC Zenoah (G34/G160)	26,90
PB455028	Arrancador 2 Trinquetes	28400-ZG9-802 28400-ZG9-803 28400-ZG9-M00	GXV140 - GXV160KD	29,90
PB454216	Arrancador	28400-883-040ZB	Honda G150 Honda G200	28,90
PB5109702	Arrancador	28400-ZOD-V04ZC	GX100 / 100R (Pison)	29,75

**ARRANCADOR COMPLETO ADAPTABLE A MOTORES BRIGGS - TECUMSEH - ROBIN**

REFERENCIA	DESCRIPCIÓN	REFERENCIA ORIGINAL	PARA MOTORES	P.V.P SIN I.V.A. ADAPTABLE	P.V.P SIN I.V.A. ORIGINAL
 PB453156	Tecumseh	590420A	Aspera	66,90	-
 PB454290	Tecumseh	14210090 1421095 1421056 14210076	Prisma, Synergy Vantage 35, OHV	61,75	-
 PB455796	Briggs & Stratton	497830	5HP Series:133200 135200 y 135700	32,75	43,15
 PB454294	Briggs & Stratton	497598	Quantum Europa	39,75	65,15
 PB454401	Briggs & Stratton	497680	Vertical 12CID-5CV	39,75	57,45
 G197	Briggs & Stratton	693900		31,95	-
 PB990027	Briggs & Stratton	796497	111P / 112P 114P / 129S	37,90	53,25
 PU0001200124	Mitsubishi	LB151B08020	GT400		129,75
 PU0001180016	Loncin	193500046-0001	LC170F		46,35
 PB018419	Robin		EY-15	23,75	
 G189	Robin	2685020130	EH17 / EX17 / EY20	23,75	-
 PU0001210010	Rato	28200 Z440110 H300	R180 / R210	-	47,75



## POLEAS PUESTA EN MARCHA ADAPTABLES

	REFERENCIA	DESCRIPCIÓN	MODELO	P.V.P SIN I.V.A.
 (1)	<b>PB4562220</b>	Polea	Alpina · Stiga · Castor	5,95
	<b>PB008110</b>	Polea	Kawasaki 59101-2067	5,95
 (2)	<b>PB990033</b>	(1) Polea P/M Ref.537065901	Husqvarna 357XP / 359	6,95
	<b>G201</b>	(2) Polea P/M	Part.: 500/540/543 · Husq. 50/51/55 · Ref.505303735	5,15
 (4)	<b>PB5106216</b>	Polea P/M	Shidaiwa: C320 / CS350 / CS2600	15,09
	<b>G200</b>	(4) Polea P/M	Partner: 350/351/352/370/401/422 · Husqvarna 236 Jonsered · McCulloch · Poulan · Ref.545034301	4,95
 (5)	<b>G019</b>	(5) Polea P/M	Honda: GX160 ( GX200	4,75
	<b>PB990034</b>	(6) Polea P/M Ref.503775301	Husqvarna 232 / 235 / 322 / 325R	5,50
 (6)	<b>PB990035</b>	(7) Polea P/M Ref.11181901000	Stihl 024 / 026 / 028 / MS240 / MS260 / MS280	4,75
	<b>537201901</b>	(8) Polea P/M	Partner: B405/B450/410/510/41/511 4200/4600/5200 · Husqvarna · Jonsered · McCulloch	11,95
 (7)	<b>G202</b>	Polea P/M	Husq. 36/41/136/141 · Part. 365/405/470 · Ref. 530069313	8,25
	<b>G203</b>	Polea P/M	Husqvarna: 40/45/240R/245R · Ref. 537201901	6,75
 (8)	<b>G204</b>	11. Polea P/M Arranque facil	Husqvarna: 340/345/350 · Jons. 2150 · Ref. 537423301	6,25
	<b>G205</b>	Polea P/M	Stihl: 038/041/042/045/048/051/056/090 · Ref.11171901011	4,95
 (10)	<b>G206</b>	Polea P/M	Stihl: 029/036/039/044/MS290/MS390 MS440/MS460 · Ref. 11281950400	4,95
	<b>G207</b>	Polea P/M	Stihl: 017/019/MS170 · Ref. 11231950400 MS180 / MS210	4,95
 (11)	<b>G208</b>	Polea P/M	Stihl: 024/026/028/034/MS240/MS260 · Ref. 11251950401	3,95
	<b>G209</b>	Polea P/M	Stihl: 085 / MS660 / 064 / 066 · Ref. 11221950400	5,95
 (17)	<b>C26-110</b>	17. Polea P/M	Camon: C26/C26 PRO/TCS2600	3,50
	<b>C37-ZJB062</b>	18. Polea P/M	Camon: C37/C41/TCS4100 Zenoah: 2500	3,50
 (18)	<b>C45-ZJA041</b>	19. Polea P/M	Camon: C45/C50/TCS4600/TCS5000 Zenoah: 4500 / 5200	4,50
	<b>C62-B019</b>	Polea P/M	Camon: C62	4,50
 (19)	<b>ZJC047</b>	Polea P/M	GJB25D	4,50
	<b>A25.2110.0002</b>	Polea trinquetes	XCS2500C/TC	4,90
 (24)	<b>SH2320007365</b>	Polea P/M	Camon: CG260E/EBV260E	4,95
	<b>SH2320007367</b>	24. Polea P/M	Camon: CG330-E / CG430-E	3,95

**MUELLES PUESTA EN MARCHA ADAPTABLES**

REFERENCIA	DESCRIPCIÓN	MODELO	P.V.P SIN I.V.A.
 C26-111	Muelle P/M	Camon: C26/C26 Pro/TCS2600	4,15
C50-A040	Muelle P/M	Camon: C37/C41/C45/C50/TCS4100/TCS4600/TCS5000	4,15
C62-B016	Muelle P/M	Camon: C62 / TCS6200	4,15
ZJC046	Muelle P/M	Camon: GJB25D	4,15
(12) TCS4100A-41	Muelle RS	TCS4100	3,90
SH2320007379	Muelle P/M	Camon: CG260E/EBV260E/3WZ-6F	4,95
SH2320018251	Muelle P/M	Camon: CG330-E/CG430-E/3WT-300A / EB500	4,95
(2) TCS4100A-41	Muelle RS	Camon: TCS4100	3,90
TCS4100A-45	Muelle P/M	Camon: TCS4100	4,95
SH2320040303	Muelle P/M	Camon: 3GC430 / 3GC520	3,96
(2) AI180070	Muelle P/M	Bluebird: R29 / H27E / NH28E	9,95
AI180240	(12) Muelle P/M	Bluebird: 41 / 47 / 54 / F41 / F54	9,25
PB990038	Muelle P/M Ref. 502200601	Husqvarna 343R / 232R / 235R / 355R / 545RX	5,90
PB990037	Muelle P/M Ref. 521637401	Husqvarna 253R / 253RB / 553RS / 553RBX	5,90
PB990036	(2) Muelle P/M	Husqvarna 137 / 142 / 235E / 236E / 240E Ref.530049095	5,90
G229	Muelle P/M	Alpina 360/370/380/390/410/460/510 • Ref. 4611480	5,75
(3) G230	(3) Muelle P/M	Husqvarna: 36/40/41/45/51/55/136/141/240R/245R Partner: 410/411/510/511/4200/B405/B450 • Ref. 501763101	5,90
G228	Muelle P/M	Kawasaki: TH43/TH48/TD40/TD48 • Ref. 920812318	6,75
G233	Muelle P/M	Husqvarna: 340/345/350/353/359 • Ref. 503859901	3,95
G234	Muelle P/M	Husqvarna: 365/372/385/390 • Ref. 503787201	4,50
G235	Muelle P/M	Husqvarna: 61/162/266/268/272/281 • Ref. 501520402	7,95
A25.0110.0004	Muelle P/M	XCS2500C/TC	5,35
G238	Muelle P/M • Ref. 4000132	Oleo-Mac: 260/261/264/271/272/284 • Efcó	7,95
G239	Muelle P/M • Ref. 11181900600	Stihl: 024/026/028/032/034 FS180/FS260/FS280	4,75
G240	Muelle P/M • Ref. 11291900601	Stihl: 017/019/021/023/025	4,50
G241	Muelle P/M • Ref. 11221900605	Stihl: 036/044/064/066/MS360 MS440/MS460	5,89
G242	Muelle P/M • Ref. 11171900601	Stihl: 038/045/048/050/051/056/075	5,95
G243	Muelle P/M • Ref. 42231900600	Stihl: TS400	3,95
G244	Muelle P/M • Ref. 42241900600	Stihl: TS410/TS420/TS500/TS700/TS800	5,96
PB000000	Muelle P/M	Honda GX110 / GX120 / GX140 / GX160	4,95
PB000002	Muelle P/M	Honda GX240 / GX270 / GX340 / GX390	5,75

**CUERDA DE ARRANQUE CAMON**

REFERENCIA	DESCRIPCIÓN	P.V.P SIN I.V.A.
TC101069	Cuerda P/M Ø 2,8 mm X 100 m	18,90
TC101070	Cuerda P/M Ø 3,0 mm x 100 m	19,95
TC101071	Cuerda P/M Ø 3,5 mm x 100 m	23,75
TC101072	Cuerda P/M Ø 4,0 mm x 100 m	26,75
TC101073	Cuerda P/M Ø 4,5 mm x 100 m	31,75
TC101074	Cuerda P/M Ø 5,0 mm x 100 m	35,75
TC101075	Cuerda P/M Ø 5,5 mm x 100 m	36,75
TC101076	Cuerda P/M Ø 6,0 mm x 100 m	41,75

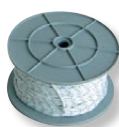
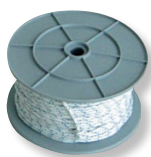
**CUERDA DE ARRANQUE BRIGGS & STRATTON**

SY790965	Cuerda P/M Ø 3,2 mm x 61 m	-
SY790966	Cuerda P/M Ø 3,6 mm x 62 m	-
SY790967	Cuerda P/M Ø 4,4 mm x 61 m	-

**CUERDA DE ARRANQUE CORTADA**

PB453701	Cuerda Arranque Longitud: 1,8 m / Grosor: 3,5 mm	0,95
PB453703	Cuerda Arranque Longitud: 1,8 m / Grosor: 4,5 mm	0,99
PB455730	Cuerda Arranque Longitud: 1,8 m / Grosor: 2,5 mm	0,90
PB453705	Cuerda Arranque Longitud: 1,8 m / Grosor: 6 mm	0,99
PB853197	Tirador+Cuerda arranque Longitud: 1,3 m / Grosor: 5 mm	2,59
PB4055045	Tirador + cuerda motores 1,70m x Ø 9mm	7,50



**TIRADORES DE CUERDA P/M ADAPTABLES**





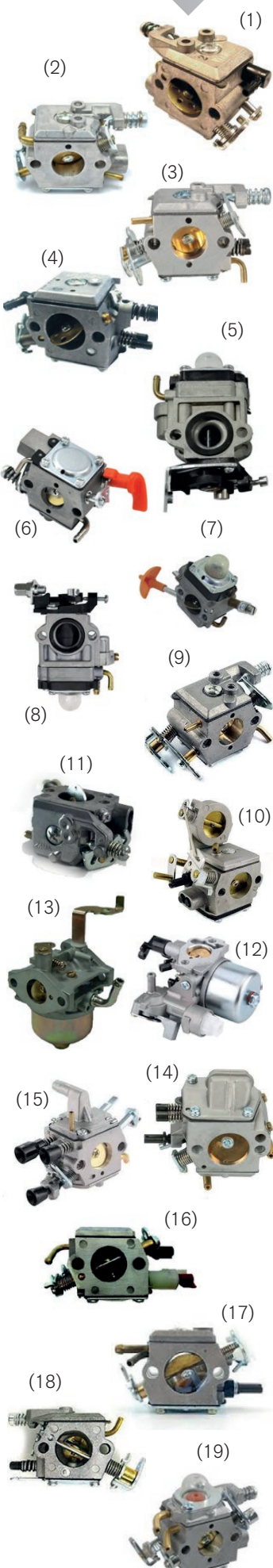







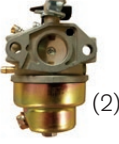
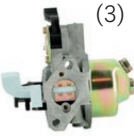

	REFERENCIA	DESCRIPCIÓN	REF. ORIGINAL	PARA MOTORES	P.V.P SIN I.V.A.
(1) 	<b>PB455784</b>	1. Mando arrancador Honda	28461-ZE1-003	GX110, 120, 140, 160, GXV120, 140, 160	1,95
(2) 	<b>PB453214</b>	2. Mando arrancador	590387 24230009	Tecumseh	1,39
(3) 	<b>PB455792</b>	3. Mando arrancador	393152	B&S Quantum & Europa 2 5,5 HP	1,50
(4) 	<b>PB453017</b>	4. Mando arrancador	490652	Briggs & Stratton	3,70
(5) 	<b>PB453580</b>	5. Mando arrancador	11211953400	Stihl	1,60
(6) 	<b>PB453016</b>	6. Mando arrancador		Motosierras	1,94
(7) 	<b>PB456009</b>	7. Mando arrancador motosierras	503543901	Husqvarna Jonsered Partner	1,10
(8) 	<b>TCS4600A-41</b>	8. Tirador cuerda	C37/C41/C45/C50	Camon	1,69
(11) 	<b>SY691915</b> <b>PB5109939</b>	11. Tirador cuerda 11. Tirador cuerda	Briggs & Stratton Briggs & Stratton	Origen Adaptable	5,50 1,98
(12) 	<b>SY799716</b>	12. Tirador cuerda	Briggs & Stratton	Varios	6,05
(14) 	<b>ML262633</b>	14. Tirador cuerda	M42SH-RS/M50SH-RS M50BKC/BKC5020/BC420H BC4320H-RS/BC500H BC5020H-RS/BCV5020 BC421 / BC501H	Maruyama	5,77
(15) 	<b>PB010154</b>	(15) Asa arranque	B&S/Tecumseh		3,69

## CARBURADORES ADAPTABLES

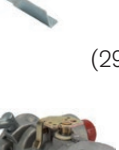

REFERENCIA	DESCRIPCIÓN	MODELO	P.V.P SIN I.V.A.
<b>C26-094</b>	1. Carburador WT793A	Camon: C26/C26PRO/TCS2600	44,95
<b>C37-ZJB082</b>	2. Carburador WT840A	Camon: C37/C41/TCS4100	46,95
<b>C50-B064</b>	3. Carburador WT846A	Camon: C45/C50/TCS4600/TCS5000/TCS5600	55,75
<b>C62-A014</b>	4. Carburador HDA 238A	Camon: C62 / TCS6200	79,75
<b>ZJA053</b>	5. Carburador	Camon: GJB-25D	26,90
<b>SH2320037863</b>	Carburador	Camon QJB270	29,95
<b>A25.2101.0500</b>	6. Carburador	Camon: XCS2500C / TC ECHO: CS2511	57,90
<b>SH2320065695</b>	7. Carburador	Camon: E800-E	34,96
<b>SH2320026450</b>	Carburador	Camon: EBV260E	29,95
<b>SH2320113743</b>	Carburador	Camon: CG260E / CG330E / GJD330 / 3CS23EF	26,90
<b>SH2320115116</b>	8. Carburador	Camon: CG430/3WT300 / BG520A 3GC430 / 3GC520	24,90
<b>SH2320034321</b>	Carburador	Camon: BG431	27,90
<b>G275</b>	9. Carburador	Prtnr: 351/370/420/401	35,75
<b>PB990002</b>	10. Carburador Zama	Partner: K750/K760 • Ref. 503283209	59,75
<b>PB990040</b>	11. Carburador 538242893	Husqvarna 50 / 51 / 55	41,75
<b>PB990039</b>	12. Carburador 2776230130	Robin EX17 / EP17 / EX21	31,75
<b>G3007</b>	13. Carburador	Robin EY15	19,75
<b>G3008</b>	Carburador	Robin EY20	19,75
<b>G268</b>	Carburador (sin catalizador)	Stihl: 017/018/MS170/MS180 • Ref. 11301200603	35,75
<b>G1520</b>	Carburador	Stihl: 024/026/MS240/MS260	29,00
<b>G269</b>	Carburador	Stihl: 021/023/025/MS210 • Ref. 11231200600	35,00
<b>G1522</b>	14. Carburador Ref. 11281200625	Stihl: 044/046/MS440/MS460	29,00
<b>PB990041</b>	15. Carburador Ref. 41291200607	Stihl: FS400 / FS450 / FS480 SP400 / SP450	46,95
<b>G1523</b>	Carburador Ref. 41471200603	Stihl: FR400C / FS4060C FS460RC / FS460TC	36,75
<b>G272</b>	16. Carburador Zama Ref. 503281812	Husqvarna: 345/350/340/353 Jonsered: 2145/ 2150 / 2152 / 2153	39,00
<b>G273</b>	17. Carburador Ref. 503283203	Husqvarna: 365/372 • Jonsered: 2165/2171	35,90
<b>G274</b>	18. Carburador Walbro Ref. 545013503	Husqvarna: 136/137/141/142/36/41	19,75
<b>PB990001</b>	19. Carburador Ref. 230540141	Alpina: Star 45/55	29,70
<b>G1521</b>	Carburador Ref. 11251200606	Stihl: 034/036/MS340/MS360	37,00

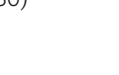









## CARBURADORES ADAPTABLES

	REFERENCIA	DESCRIPCIÓN	MODELO	P.V.P SIN I.V.A.
 (1A)	<b>G1524</b>	(1A) Carburador Kawasaki	TH43 / TH48	33,75
 (1)	<b>G1525</b>	Carburador Zenoah 848H008100	EBZ8000 / 8001 / Husqvarna 580BTS	39,75
 (2)	<b>G1526</b>	Carburador Zenoah	G2500 / G250TS	21,75
 (3)	<b>G1527</b>	Carburador Zenoah	G4500 / G5200	19,75
 (9)	<b>G1528</b>	Carburador Zenoah	G629 / G6200	29,75
 (17)	<b>G3004</b>	(1). 16100 - ZOH - 844	Honda GX25	29,75
 (18)	<b>G3005</b>	(2). 16100-883-355	Honda G-200	26,90
 (23)	<b>G3006</b>	(3). 16100-Z4E-003	Honda GX-100	42,00
 (24)	<b>PB456388</b>		Carburador GX135	33,90
 (25)	<b>PB456389</b>		Carburador GX140	18,90
 (26)	<b>PB456391</b>	(9). 16100-ZF1-005 16100-ZK7-W00 16100-ZH9-W50 16100-ZH8-W61	Carburador GX160	18,90
 (27)	<b>PB200071</b>	16100-ZL0-W51	Carburador GX200	21,90
 (28)	<b>PB240071</b>	Honda GX240	Carburador GX240	22,90
 (29)	<b>PB270071</b>	Honda GX270	Carburador GX270	29,95
 (30)	<b>PB340071</b>	Honda GX340	Carburador GX340	39,90
 (31)	<b>PB390071</b>	Honda GX390	Carburador GX390	39,95
	<b>PB400001</b>	16100-Z1V-003	Carburador GXV160	25,95
	<b>G3001</b>	188 F/P	Carburador con leva aire WM5500	29,00
	<b>G3002</b>	(17). 177 F/P	WM3500	29,80
	<b>G3003</b>	(18). 188 F/P	WM5500	39,75
	<b>PB400002</b>	Carburador	GC135 / GCV135/GCV140	39,00
	<b>G3019</b>	Carburador	WM2500	29,75
	<b>PU0001180020</b>	Carburador D19	Loncin 721 RA /R210	46,75
	<b>SY799868</b>	(23). Carburador adaptable	Briggs&Stratton QWANTUM	35,92
	<b>PB632107</b>	(24). Carburador adaptable	Tecumseh	39,75
	<b>PB632230</b>	(25). Carburador adaptable	Tecumseh	39,75
	<b>PB632334</b>	(26). Carburador adaptable	Tecumseh	39,75
	<b>PB632615</b>	(27). Carburador adaptable	Tecumseh	39,75
	<b>PB632671</b>	(28). Carburador adaptable	Tecumseh	49,75
	<b>PB632795</b>	(29). Carburador adaptable	Tecumseh	39,75
	<b>PB640017</b>	(30). Carburador adaptable	Tecumseh	39,75
	<b>PB640025</b>	(31). Carburador adaptable	Tecumseh	39,75
	<b>PU0001030012</b>	Carburador EA 190V	Junior / Xplorer	99,75

## KIT REPARACIÓN CARBURADORES ADAPTABLES

	REFERENCIA	DESCRIPCIÓN	MODELO	P.V.P SIN I.V.A.
(1)	<b>Ai82-75</b>	1. Aguja Carburador Walbro WT	Tillotson · Walbro · Zama	2,13
(2)				
(3)	<b>Ai82-82</b>	2. Aguja Carburador Walbro WZ/WYK	Tillotson · Walbro · Zama	2,15
(4)				
(5)	<b>SY398188</b>	3. Aguja y asiento Briggs	Quantum 5HP / 6HP	8,00
(6)	<b>PB5201321</b>	3. Aguja y asiento adaptable	Quantum 5HP / 6HP	3,80
	<b>C41-ZJA078A</b>	4. Cebador gasolina	C26/C37/C41/C45/C50	1,19
(7)	<b>C37-ZJB017</b>	5. Válvula respiro gasolina	C26/C37/C41/C45/C50/TCS2600 TCS4100/TCS4600/TCS5000	1,90
	<b>G282</b>	6. Juego juntas carburador	Walbro K13-WYK	10,90
	<b>3-K10-HDB</b>	7. Kit reparación carburador	Walbro HDB	4,95
(9)	<b>3-K10-HDC</b>	Kit reparación carburador	Walbro HDC Stihl · Homelite	7,75
	<b>G281</b>	9. Juego juntas carburador	Walbro WT/WAT D10-WAT	5,75
(10)	<b>3-95-515</b>	10. Diagrama carburador Ref. 505316715	Walbro 95-515/550/650/7000/P70	4,49
(11)	<b>PB5205075</b>	11. Membrana carburador Briggs Straton	8 / 11 / 14 / 16 / 18HP Twin	2,59
(12)				
(14)	<b>3-95-546</b>	12. Diagrama carburador Tillotson	Walbro 95-546	1,91
	<b>G280</b>	Juego juntas carburador adaptables	K10WAT 351/370/420/401/422	6,98
(15)	<b>G283</b>	14. Juego juntas carburador adaptables	K20-WAT	9,90
	<b>G284</b>	15. Juego juntas carburador adaptables	K20-WYJ	9,50

## KIT REPARACIÓN CARBURADORES ADAPTABLES

REFERENCIA	DESCRIPCIÓN	MODELO	P.V.P SIN I.V.A.
 (16) <b>G285</b>	16. Juego juntas carburador adaptables	RK26HS Tillotson · Husqvarna 235/240	8,90
 (17) <b>G286</b>	Kit reparación carburador	Mitsubishi TL33/TL43/TL52	10,90
 (18) <b>G287</b>	18. Kit reparación carburador	Zama C3 RB31	8,70
 (19) <b>G279</b>	19. Kit reparación carburador	Zama C1Q RB40	7,98
 (20) <b>AI140-70</b>	20. Filtro carburador ø 8 mm	Tillotson Walbro 140-70 Zama	0,89
 (21) <b>501222301</b>	21. Aguja carburador 17mm	Walbro: 82-75 Tillotson: 34-216 Zama: C1 / C1U / C2	2,45
 (22) <b>501427101</b>	22. Tope muelle eje carburador	Walbro 98-234	0,69
 (23) <b>AI98-234</b>	23. Muelle y carburador	Walbro 98-234	0,95
 (24) <b>SY795083</b>	24. Membrana +junta origen	3,5/3,75HP vertical, Classic y Sprint Briggs&Stratton	5,60
 (25) <b>PB5200497</b>	24. Membrana +junta adaptable	3,5/3,75HP vertical, Classic y Sprint Briggs&Stratton	2,29

## TOMAS DE ADMISIÓN ADAPTABLES

 (1) <b>C26-020</b>	1. Toma de admisión	Camon C26/TCS2600	3,95
 (2) <b>C37-ZJA002</b>	2. Toma de admisión	Camon C37/C41/TCS4100	3,95
 (3) <b>C45-ZJB013</b>	3. Toma de admisión	Camon C45/TCS4600	3,95
 (4) <b>C50-B013</b>	4. Toma de admisión	Camon C50/TCS5000	3,95
 (5) <b>C62-A012</b>	5. Toma de admisión	Camon C62	3,95
 (6) <b>PB456609</b>	6. Toma de admisión Ref.503161602	Partner: 500/540/543 Husqv. 41/50/36/37/40/45/50/51/55/136/137	8,95
 (7) <b>PB990046</b>	7. Toma de admisión Ref.506013202	Husqvarna 40 / 45 · Jonsered 2041 / 2045 240R / 245R	9,90
 (8) <b>PB990042</b>	8. Toma de admisión Ref. 3744710	Alpina 450 / 460 / 500 / 510	10,95
 (9) <b>PB990043</b>	9. Toma de admisión Ref. 4250100	Alpina 600 / 650 / 660	10,95
 (10) <b>PB990044</b>	10. Toma de admisión Ref. 699644	Briggs & Stratton 3,5 HP	13,30
 (11) <b>PB990045</b>	11. Toma de admisión Ref. 794305	Briggs & Stratton Quantum	7,95
 (12) <b>ZJA048</b>	12. Toma de admisión	Camon GJB25D	4,95
 (13) <b>SH2320002274</b>	13. Toma de admisión	EBV260E	5,90
 (14) <b>SH2320064541</b>	14. Toma de admisión	CG260E	4,90
 (15) <b>SH2320002248</b>	15. Toma de admisión	CG330E	4,95
 (16) <b>SH2320058955</b>	16. Toma de admisión	CG430 / 3GC430 / 3GC520	4,94
 (17) <b>PB990009</b>	17. Toma de admisión	GX160 / WM50 / WM1000	4,98
 (18) <b>A25.2101.0300.18</b>	18. Tubo de admisión	XCS2500C/TC	7,78









## TAPÓNES ACEITE Y GASOLINA ADAPTABLES

	REFERENCIA	DESCRIPCIÓN	MODELO	P.V.P SIN I.V.A.
(1)	A50.5100.0100	Tapón aceite y gasolina	XCS2500C/TC	3,95
	PU0001000233	Tapón gasolina	RV170 / EA190 / GC / GCV	6,90
(2)	SH2320091834	Tapón gasolina	CG260 / 330 / 430 / EBV260 / Q33 / 3GC	2,95
	C26-057	(1) Tapón aceite /gasolina	Camon: C26/C26PRO/TCS2600 · Zenoah: G2500	3,50
(3)	C41-ZJA073	(2) Tapón aceite	C37/C41/C45/C50/TCS4600/TCS5000	3,10
	C41-ZJA069	Tapón gasolina	C37/C41/C45/C50 TCS4600/TCS5000	3,10
(4)	C62-B058	Tapón aceite	Camon: C62 · Zenoah: G621	4,59
	C62-B011	Tapón gasolina	C62 Antigua	4,59
	YD62.00.03-1	Tapón gasolina	C62 Moderna / TCS6200	2,79
(5)	ZJC054	Tapón gasolina	GJB-25D	3,21
	SH2320003486	Tapón aceite	Camon: BG431	2,95
(6)	SH2320091834	Tapón gasolina	Camon: CG260 / 330 / 340 / EBV260 / Q33 / 3GC	2,95
	SH2320048277	Tapón gasolina	Camon: CG330-E/CG430-E	2,95
	SH2320003624	Tapón gasolina	Camon: SG250	2,95
(7)	SH2320035216	Tapón gasolina / aceite	Camon: GJD330	2,95
	PB990011	(3) Tapón aceite	Partner: 350/351/352/370/401/420/470 465/495/545/605/842 · Poulan	3,95
(8)	538227507	Tapón aceite EM	Partner: 610/720 · McCulloch: MAC 54/MAC61	5,75
	PB456362	(4) Tapón aceite EM Ref. 501626601	Partner: 550/650/7000/660/7700/710 Husqvarna: 61/66/162/234/238/266/272	5,90
(9)	AI723730	(5) Tapón gasolina	Bluebird: 20 / 41 / 54 / H27E	4,99
	PB990010	Tapón gasolina	Partner: 350/351/352/370/401/420/470 McCulloch: 335 / 438 / 440 / 442 / 740 / 742	5,96
(10)	SH2320036647	(6) Tapón gasolina	BG520A / QJB270 / 3WZ-6F	2,98
	PB456363	(7) Tapón aceite Ref. 501765602	Husqvarna: 36/41/50/51/55/136/141/154/261 Jonsered	4,29
(11)	G330	Tapón aceite Ref. 537281502	Husqvarna: 340/345/350/351/353	8,95
	G335	(8) Tapón gasolina Ref. 501431402	Husqvarna: 61/66/268/272 Jonsered 625/630/631/670	3,60
	G336	Tapón gasolina Ref. 537215202	Husqvarna: 288/365/395	4,55
(12)	G337	(9) Tapón gasolina Ref. 501819601	Husqvarna: 340/345/350	3,50
	G338	Tapón gasolina Ref. 501819602	Husqvarna: 365/372/395	4,55
(13)	G350	(11) Tapón aceite Ref. 00003500526	Stihl: 021/024/026/028/034/038/042/048 181/192/193/200/210/230	4,55
	G351	(12) Tapón gasolina Ref. 00003500525	Stihl: 021/023/025/029/034/038/042	4,55
(14)	G352	(14) Tapón aceite Ref. 00003500510	Stihl: 018/026/029/036/038/039/044/046/066	3,15
	G353	(13) Tapón gasolina Ref. 00003500520	Stihl: 018/026/029/036/038/039/044/046/066	3,15

**TAPÓN DEPÓSITO GASOLINA ADAPTABLES HONDA - BRIGGS STRATTON - MTD**

REFERENCIA	DESCRIPCIÓN	REFERENCIA ORIGINAL	PARA MOTORES	P.V.P SIN I.V.A.
 <b>PB455893</b>	Tapón plástico Honda Inter. 61,30 mm	17620-ZH7-013 17620-ZH7-023	GX110/GX120/GX140 GX160/GX200/GX240 GX270/GX390	3,90
 <b>PB455894</b>	Tapón metálico Honda Inter. 66,00 mm	17620-ZE2-W00 17610-402-010	GX110/GX120/GX140 GX160/GX200/GX240 GX270/GX390	4,98
 <b>PB455895</b>	Tapón plástico Honda Inter. 46,50 mm	17620-ZL8-003 17620-ZL8-073	GCV130/GC130 GCV160/GC160	3,50
 <b>PB455859</b>	B&S 397975 MTD 751-3111 Inter. 51,95 mm	J. Deere AM107344 Murray 23711, 92317	Snapper 1-2515, 1-9378 Simplicity 1678045, 1714020	7,85
 <b>PB990090</b>	Tapón	168FB/P	WM500/WM1000 QGZ50-30	2,95
 <b>SY692046</b>	Tapón	692046	Briggs&Stratton Quantum	6,10
 <b>SY791545</b>	Tapón	791545	Briggs&Stratton 2/3 y 5HP	8,40
 <b>SY494559</b>	Tapón	494559	Briggs&Stratton 3/5 HP	16,00
 <b>PB455859</b>	Tapón gasolina	Ø int.: 50,8mm	Briggs&Stratton / MTD Kubota / Murray / Stiga	7,85
 <b>PB990090</b>	Tapón gasolina		WM500 / WM1000 / QGZ50-30 QGZ80-30	2,95
 <b>PU0001000233</b>	Tapón gasolina	Pubert	Yamaha Explorer GC / GCV / RV / EA190	4,90
 <b>PU0001180037</b>	Tapón gasolina		721RA / GT400	4,95

**TAPÓN DEPÓSITO ACEITE VARIOS MOTORES ADAPTABLES HONDA - BRIGGS STRATTON - TECUMSEH**

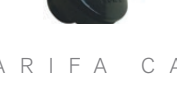
REFERENCIA	DESCRIPCIÓN	REFERENCIA ORIGINAL	PARA MOTORES	P.V.P SIN I.V.A. ADAPTABLE	P.V.P SIN I.V.A. ORIGINAL
 <b>PB453027</b>	Tapón aceite B&S y Tecumseh	281658s	Modelo Standard B&S Tecumseh 27625	1,85	3,25
 <b>PB455860</b>	Tapón aceite B&S	280663	Quantum	1,95	
 <b>SY691913</b>	Tapón aceite B&S	691913	Series 114900 a 114995 4 HP	-	3,95
 <b>PB456422</b>	Tapón aceite Honda	15620 - Z64 - 910 25611 - 735 - 000	GX240, 270, 340, 390	3,97	
 <b>PB456423</b>	Tapón aceite Honda	15600 - 735 - 003	GX240K1 / GX270 GX340K1 / GX390K1	1,69	
 <b>PB456424</b>	Tapón aceite Honda	15600 - ZE1 - 003	GX110 / GX120K1 / GX140 GX160K1 / GX200	2,15	
 <b>PB456425</b>	Tapón aceite Honda	15650 - ZMO - 801	GCV 135, 160	1,80	
 <b>PB456428</b>	Tapón aceite Honda	15600 - ZG4 - 003	GX110, GX120 GX140, GX160	2,40	

## CAMPANAS DE EMBRAGUE MOTOSIERRAS ADAPTABLES

REFERENCIA	DESCRIPCIÓN	MODELO	P.V.P SIN I.V.A.
<b>C26-083</b>	Campana 3/8BP 6T	Camon: C26/TCS2600 · Zenoah: G2500	10,75
<b>C26-083 1/4</b>	Campana 1/4	Camon: C26 Pro · Zenoah: G2500	13,90
<b>C26-089</b>	Cojinete 10X13X13	Camon: C26 / C26 Pro / TCS2600 · Zenoah: G2500	3,95
<b>C37-ZJA049</b>	Campana 3/8 BP GT	Camon: C37 / C41 / TCS4100 · Zenoah: G3800	11,90
<b>C26-089</b>	Cojinete 10x13x13	Camon: C37 / C41 / TCS4100 · Zenoah: G3800	3,95
<b>C45-ZJB049</b>	Campana (sin corona)	C45 / C50 / TCS4600 / TCS5000 · Zenoah: G455	11,95
<b>C45-ZJB048</b>	Cojinete 12x15x14,5	C45 / C50 / TCS4600 / TCS5000 · Zenoah: G455	3,95
<b>CASRK27</b>	Corona 325x7	C45 / C50 / TCS4600 / TCS5000 · Zenoah: G455	2,50
<b>C62-A092</b>	Campana (sin corona)	Camon: C62 · Zenoah: G621	14,90
<b>C62-A091</b>	Cojinete 10x14x12,5	Camon: C62 · Zenoah: G621	3,95
<b>C62-A093</b>	Corona 3/8x7 · Oregon: 18720	Camon: C62 · Zenoah: G621	3,95
<b>ZJB001</b>	Campana embrague	GJB-25D	7,95
<b>ZJB013</b>	Rodamento 6001-2z	GJB-25D	2,50
<b>CASRK27</b>	Corona Carlton 325x7	Ref. Oregon: 11892	2,50
<b>CASRA18</b>	Corona Carlton 3/8x8	Ref. Oregon: 22273	2,50
<b>G373</b>	Corona 3/8x7	Ref. Oregon: 68210	3,25
<b>G374</b>	Campana fija 325x7 Ref. 503088702	Husq.: 50/51/55/154/254/262/254/257 Partner: 500/540/543/465/495	13,95
<b>G375</b>	Campana fija 325x7 Ref. 530069342	Husqvarna: 36/41/136/141 Partner: 405/470 · Jonsered: 2035	13,95
<b>G376</b>	Campana flotante 325x7 Ref. 503745401	Husq.: 50/51/55/154/254/262/254/257 Partner: 500/540/543/465/495	13,95
<b>G377</b>	Campana flotante 3/8x7 Ref. 501831504	Jonsered: 625/630/670 Husqvarna: 61/66/162/272/266/268	15,95
<b>G378</b>	Campana fija 3/8x7 Ref. 501255901	Husqvarna: 65/77/160/163/180/260/263	13,95
<b>G379</b>	Campana flotante 325x7	Husqvarna: 357/359/355	13,95
<b>G380</b>	Campana fija 325x7 Ref. 503873073	Jonsered: 2141/2145/2150 Husqv.: 340/345/350/351/353/445/450	13,95
<b>G381</b>	Campana fija 3/8x7 Ref. 503932471	Jonsered: 2165/2171/2163 Husqvarna: 365/371/372	13,95
<b>G382</b>	Campana flotante 3/8x7 Ref. 503934871	Husqvarna: 359 / 355 / 357 Jonsered: 2156 / 2159	13,95
<b>G383</b>	Campana flotante 325x7 Ref. 503159802	Husqvarna: 40/45 Partner: 410/411/510/511	13,95
<b>G368</b>	Campana 325x7 Ref. 4121200	Alpina P400/P450/P460/P500/P510	15,95
<b>G369</b>	Campana 3/8 LP Ref.4121208	Alpina P350/P360/P361/P370	16,95
<b>G389</b>	Campana 3/8 x7	Partner S50/55/P70/550/650/7000	15,95
<b>G387</b>	Campana 3/8 LPx6 Ref.530047061	Partner: 351/351/352/370/401/422	13,95
<b>538243909</b>	(32) Corona + piñón 3/8LP 6T	Partner / McCulloch / AL-KO	22,69
<b>G360</b>	Campana 325x7 fija Ref.11236402074	Stihl: 021/023/025/MS210/MS230/MS250	13,95
<b>G361</b>	Campana 3/8x7 fija Ref.11286402000	Stihl: 044/046/MS440	13,95
<b>G362</b>	Campana 3/8x7 fija Ref.11256402000	Stihl: 029/034/039	13,95
<b>G363</b>	Camp. 3/8 LPx6 fija Ref.11236402073	Stihl: 017/018/021/MS170	13,95
<b>G364</b>	Camp. 3/8 LPx6 fija	Stihl: 020/020AV	13,95
<b>G365</b>	Camp. 3/8 x7 fija Ref.11226402002	Stihl: 064/066/MS660	13,95
<b>G366</b>	Camp. 325x7 fija Ref.11216402004	Stihl: MS240/260/270/271/280	13,95
<b>G367</b>	Camp. 3/8x7 fija Ref.11196402000	Stihl: 038	13,95



Fija



Flotante



(32)



**CAMPANAS DE EMBRAGUE DESBROZADORES ADAPTABLES**

		REFERENCIA	MARCAS	MODELOS	P.V.P SIN I.V.A.
(1)		AI751220	1. BlueBird	F41 / F54 / ZM4 / ZM54	33,75
(2)		AI752390	2. BlueBird	R41 / R47 / R54	31,90
(3)		AI752800	3. Bluebird	T24	9,95
(4)		ZJB001	4. Camon	GJB25D	7,95
(5)		SH10204385	5. Camon	3GC430 / 3GC520	16,75
(6)		SH10200018	6. Camon	QJB270 / CG260E / GJD330	9,75
(7)		SH10202447	7. Camon	CG330E / CG430E CG415Q52	14,95
(8)		SH10201258	8. Camon	BG431 / BG520A	7,95

**CAMPANA EMBRAGUE AHOYADORES**

	REFERENCIA	MARCAS	MODELOS	P.V.P SIN I.V.A.
	AI750150	BlueBird	NEA39 / NEA52	36,98
	SH2320070746	Camon	3WT-300	13,90

## COJINETES ADAPTABLES



REFERENCIA	DESCRIPCIÓN	P.V.P SIN I.V.A.
Q101316	Cojinete 10x13x16	2,00
Q101412	Cojinete 10x14x12	1,90
Q101612	Cojinete 10x16x12	1,90
Q121613	Cojinete 12x16x13	1,90
Q121624	Cojinete 12x16x24	2,50
Q141815	Cojinete 14x18x15	3,95
Q89502	Cojinete 12,7x16,7x12,3	1,90
QB810	Cojinete 12,7x17,46x15,88	2,50
SH2320029199	Cojinete 10x14x15	3,96
C37-ZJA032	Cojinete 10x14x11	3,95
C26-089	Cojinete 10x13x13	3,95
C26-012	Cojinete 8x11x9	3,95
C45-ZJB023	Cojinete 11x15x14,5	3,95
C45-ZJB048	Cojinete 12x15x14,5	3,95
C62-A091	Cojinete 10x14x13	3,95
IN91834700	Cojinete 27x40x60x10	13,59
A25.0103.0500-1	Cojinete 10x13x10	5,80

## EMBRAGUES CPL ADAPTABLES

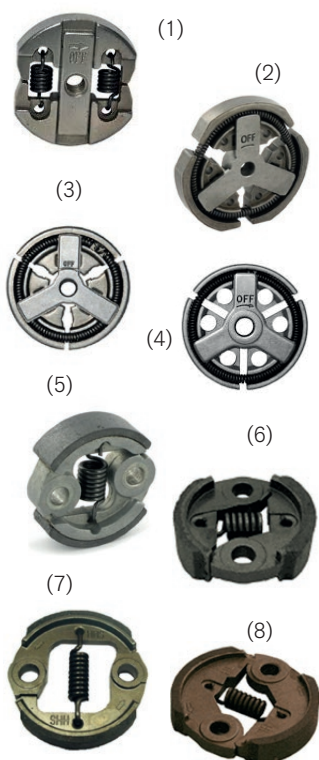











REFERENCIA	DESCRIPCIÓN	MODELO	P.V.P SIN I.V.A.
C26-084	1. Embrague CPL Camon	Camon: C26 / C26 Pro / TCS2600 Zenoah G2500	13,90
C37-ZJA051	2. Embrague CPL Camon	C37 / C41 / TCS4100 · Zenoah G3800	14,90
C45-ZJB100	3. Embrague CPL Camon	Zenoah G455 / G500 Camon C45 / C50 / TCS4600 / TCS5000	15,90
C62-A100	4. Embrague CPL Camon	C62 / TCS6200 · Zenoah G621	17,90
ZJA061	5. Embrague CPL Camon	GJB-25D	10,95
SH2320028237	6. Embrague CPL	CG260 / 3WZ-6F / QJB270	8,90
SH2320056058	7. Embrague	Camon 3GC430/3GC520/CG330-E Q33 / Q43 / Q52 / CG430-E/BG520A	10,90
SH2320013769	8. Embrague Camon	BG431 / BG520A	10,90







**EMBRAGUES CPL ADAPTABLES**

	REFERENCIA	DESCRIPCIÓN / R.O.	MODELO	P.V.P SIN I.V.A.
(8)	<b>AI721390</b>	8. Embrague	Bluebird: R41 / R47 / R54 / NEA39E / NEA52E	39,00
(9)	<b>A25.2101.9999</b>	9. Embrague	XCS2500C/TC	16,75
(11)	<b>G421</b>	11. Embrague 41281602001	FS200/240/250/260/300/310/350/360 400/410/450 / FR410/450/460/480	22,80
(12)	<b>G479</b>	12. Embrague 13081-2221	Kawasaki TH43/TH48/TD43/TD48	11,95
(15)	<b>PB456761</b>	15. Embrague 73mm Agujero 10 mm. 13081 - 2174	Kawasaki TD33/TG33/TD40/TD48	13,95
(17)	<b>PB456763</b>	16. Embrague 51,5mm Agujero 8 mm	Mitsubishi: TL23 / TL26 Echo · Tanaka	19,95
(18)	<b>PB456764</b>	17. Embrague 76 mm Agujero 10 mm	Kawasaki · Kaaz · Tanaka	13,95
(19)	<b>PB456765</b>	18. Embrague 75,5 mm Agujero 10 mm	Kawasaki G-3K/G-4K	12,25
(22)	<b>PB456766</b>	19. Embrague 75 mm Agujero 10 mm	Kaaz TL33/TL48	14,90
(26)	<b>G457</b>	Embrague 503744402	Husqvarna: 61/261/266/268/272	19,95
(27)	<b>G458</b>	Embrague 503701502	Husqvarna: 288/281/385/390/395	16,95
(32)	<b>G459</b>	22. Embrague 503744401	Husqvarna: 371/372/365 Jonsered: 2165/2171	17,95
(33)	<b>G460</b>	Embrague 537110502	Husqvarna: 51/55/154/254/257 Partner: 400/450/540/543	22,95
(34)	<b>G461</b>	24. Embrague 537110503	Husqvarna: 340/345/346/350/353	18,90
	<b>G462</b>	25. Embrague 530014949	Husqvarna: 36/41/136/137/141/142/235/240 Partner: 351/352/370/420/401/405/422/470 Poulan: 2050/2051/2250/2450/2550	17,95
	<b>G463</b>	26. Embrague 503173102	Husqvarna: 240R/245R Partner: B405/B450	19,95
	<b>G470</b>	27. Embrague 11231602050	Stihl: 017/018/021/023/025 MS170/MS180/MS190/MS191	16,95
	<b>G471</b>	Embrague 11211602051	Stihl: 024/026/MS260/MS240/MS270/MS280	17,90
	<b>G472</b>	Embrague 11271602051	Stihl: 029/034/039/MS029 MS310/MS340/MS360/MS390	17,90
	<b>G473</b>	Embrague 11191602002	Stihl: 038/MS380/MS381	16,95
	<b>G474</b>	Embrague 11281602004	Stihl: 044/046/MS341/MS361/MS440/MS460	17,90
	<b>G475</b>	32. Embrague 11221602005	Stihl: 064/066/MS640/MS660	19,95
	<b>G476</b>	33. Embrague	Komatsu Zenoah: G250TS/G2500TS	15,90
	<b>G477</b>	34. Embrague 11231602050	Stihl: 023/025/MS230/MS250	10,95

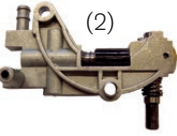
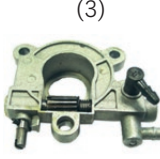

## MUELLES DE EMBRAGUE ADAPTABLES

	REFERENCIA	DESCRIPCIÓN	MODELO	P.V.P SIN I.V.A.
	<b>C26-086</b>	(1). Muelle embrague Camon 22mm	G2500/C26/C26Pro/TCS2600	1,95
	<b>C37-ZJA054</b>	(2). Muelle embrague Camon 150mm	C37/C41/C45/C50/TCS4100/TCS4600/ TCS5000	1,95
	<b>C62-A089</b>	(2). Muelle embrague Camon 174mm	C62/G621/TCS6200	1,95
	<b>SH2320008791</b>	(1). Muelle embrague Camon 31mm	CG260 / 3WZ-6F / QJB270	1,10
	<b>SH2320036555</b>	(5). Muelle embrague Camon 52mm	CG330-E / CG430-E / Q43 / Q52	1,10
	<b>ZJA024</b>	(1). Muelle embrague Camon 32mm	GJB25D	1,98
	<b>PB990019</b>	(5). Muelle embrague Ref. 3654040 - 47mm	Alpina: 34/36/40/41/42/45/55	4,50
	<b>PB456992</b>	(7). Muelle embrague Ref. 503560401 - 170mm	Husqvarna: 61/266 · Partner: 660/710/7700	2,95
	<b>PB456993</b>	(7). Muelle embrague Ref. 504210016 - 140mm	Husqvarna: 40/45/235R/240R/245R Jonsered: 2041/2045/2050	2,50
	<b>PB456994</b>	(7). Muelle embrague Ref. 530094188 - 111mm	Husqvarna: 36/41/136/137/141 Partner: 351/371/420/352	1,85
	<b>PB456995</b>	(7). Muelle embrague Ref. 501456101 - 127mm	Husqvarna: 50/51/55/254 Partner: 540/543	2,50
	<b>G500</b>	(8). Muelle embrague Ref. 00009975515 - 9mm	Stihl: 021/023/025/MS250 MS231/MS251	0,69
	<b>G501</b>	(9). Muelle embrague Ref. 00009970909 - 7,5mm	Stihl: 029/034/036/039 MS290/MS310/MS340/MS390	0,89
	<b>G502</b>	(10). Muelle embrague Ref. 00009975815 - 12mm	Stihl: 038/MS380/MS381 034/044/046	0,69
	<b>G503</b>	(11). Muelle embrague Ref. 00009975811 - 12mm	Stihl: 028/031/032/041	0,69
	<b>G504</b>	Muelle embrague. Ref. 00009975909	Stihl: 070/MS720	0,79
	<b>G506</b>	Muelle embrague. Ref. 00009975626	Stihl: 026/MS260/MS261	0,69
	<b>AI180030</b>	(12). Muelle embrague 28mm	Bluebird: 34/41/47/54/59	1,70
	<b>AI180040</b>	(12). Muelle embrague 20mm	Bluebird: 34/41/47/54/59	1,70
	<b>AI180170</b>	(11). Muelle embrague 30mm	Bluebird: 25/27/29	1,95
	<b>A25.2101.0014</b>	(13). Muelle embrague 17 mm	XCS2500C/TC	1,75
	<b>ML285656</b>	(14). Muelle embrague 19 mm	MCV3100S/MCV3100TS	6,68
	<b>ML286907</b>	(15). Muelle embrague 49 mm	BCV5020/BCV5021/BC5021/MX36EH	8,59

## BOMBAS DE ACEITE Y ACCESORIOS ADAPTABLES

	<b>C37-ZJA057</b>	1. Bomba aceite	Camon: C26/C26 Pro/C37/C41/TCS2600/ TCS4100 · Zenoah: G2500 / G3800	11,90
	<b>C45-ZJB039</b>	2. Bomba aceite	Camon: C45/C50/TCS4600/TCS5000 Zenoah: G455/G500	13,90
	<b>C62-A085</b>	3. Bomba aceite	Camon: C62 · Zenoah: G621/TCS6200	13,90
	<b>C37-ZJA058</b>	4. Sinfin engrase	Camon: C26/C37/C41/TCS2600/TCS4100 Zenoah: G2500 / G3800	3,10
	<b>C45-ZJB051</b>	5. Sinfin engrase	Camon: C45/C50/TCS4600/TCS5000	3,10
	<b>C62-A083</b>	6. Sinfin engrase	Camon: C62 · Zenoah: G621/TCS6200	3,10
	<b>A25.2114.0100</b>	7. Bomba aceite	XCS2500C/TC	13,95
	<b>A25.2101.0200</b>	8. Sinfin engrase	XCS2500C/TC	3,55
				

**BOMBAS DE ACEITE Y ACCESORIOS ADAPTABLES**

	REFERENCIA	DESCRIPCIÓN	MODELO	P.V.P SIN I.V.A.
 (7)	<b>SH2320060389</b>	7. Bomba aceite	Camon: GJD330 / QJB270	18,95
 (8)	<b>PB990018</b>	9. Bomba aceite	McCulloch • Jonsered Partner: 350/351/352/370/420/401/422	6,95
 (10)	<b>G512</b>	10. Bomba aceite 537105501	Husqvarna 340/345/346/350/353 Jonsered 2150 / 2147	14,95
 (14)	<b>538227530</b>	14. Bomba aceite EM	McCulloch: Promac 72 • Partner: 720	42,97
 (17)	<b>G514</b>	8. Bomba aceite 506027701	Partner: 400/450/410/411/460/510/511 Husqvarna: 40/45 • Jonsered 2041	21,90
 (21)	<b>G516</b>	Bomba aceite. Ref. 503521303	Husqvarna: 365/372/570/575/362/371 Jonsered: 2062/2065/2163	30,90
 (14)	<b>G517</b>	17. Bomba aceite 540057901	Husqvarna: 340/345/350/445	9,95
 (17)	<b>G518</b>	Bomba aceite 545036801	Husqvarna: 36/41/136/137/141/142	12,95
 (21)	<b>G519</b>	19. Bomba aceite 501512501	Husqv.: 61/266/268 • Jons.: 625/630/670	20,90
 (19)	<b>G520</b>	Bomba aceite 503698101	Husqvarna: 281/288	30,95
 (22)	<b>G521</b>	21. Bomba aceite 503660102	Husqvarna: 51/55	9,95
 (23)	<b>PB990085</b>	22. Bomba aceite 501777601	Husqvarna 51/55	13,90
 (24)	<b>PB990086</b>	23. Bomba aceite 503463702	Husqvarna 394 / 395 Jonsered 2095	69,00
(25)	<b>G539</b>	24. Bomba aceite. Ref. 574719301	Husqvarna 235/236/240 Jonsered 2238 / 2234	22,95
(26)	<b>G531</b>	(25) Bomba aceite Ref. 11256403201	Stihl: 034/036/MS340/MS360	20,90
(27)	<b>G532</b>	(26) Bomba aceite Ref. 11196403200	Stihl: 038/042AV/048	28,90
(27)	<b>G533</b>	(27) Bomba aceite Ref. 11236403200	Stihl: 017/018/021/023/025/MS180	10,90
(29)	<b>G534</b>	Bomba aceite Ref. 11276403204	Stihl: 029/MS290/039/390	30,95
(30)	<b>G535</b>	(29) Bomba aceite Ref. 11286403206	Stihl: 046/MS460	20,95
(30)	<b>G536</b>	(30) Bomba aceite Ref. 11226403205	Stihl: 066/MS660	20,95



## SINFINES ENGRASE ADAPTABLES



<b>G550</b>	(1) Sinfin engrase Ref. 501513801	Husqvarna: 61/261/266/268 Jonsered: 630/670/625	2,50
<b>G551</b>	(2) Sinfin engrase 325x7 503931801	Husqvarna: 340/345/346/350 351/353/355	4,95
<b>G552</b>	(3) Sinfin engrase Ref. 503756103	Jonsered: 2165/2171 • Husqvarna: 365/372	4,95
<b>G553</b>	(4) Sinfin engrase 503892202	Husqvarna: 350	5,79
<b>G554</b>	(5) Sinfin engrase 325x7 503892103	Husqvarna: 346/353	5,50
<b>G555</b>	(6) Sinfin engrase 3/8x7 Ref. 503912903	Husqvarna: 357/359	2,95
<b>G556</b>	(7) Sinfin engrase Ref. 11236407105	Stihl: 017/018/019/021/023/025	3,95
<b>PB990080</b>	(8) Sinfin engrase Ref. 503912702	Husqvarna: 357XP / 359	2,50
<b>G558</b>	(9) Sinfin engrase Ref. 11256407110	Stihl: 029/034/036/039	4,95
<b>G559</b>	(10) Sinfin engrase Ref. 11216407111	Stihl: 024/026/MS240	4,95
<b>G560</b>	(11) Sinfin engrase Ref. 11286407112	Stihl: 044/046/MS440/MS460	4,50
<b>PB990081</b>	(12) Sinfin engrase Ref.503557501	Husqvarna: 281 / 288 / 394 / 395	2,95
<b>PB990082</b>	(13) Sinfin engrase Ref.537207805	Husqvarna: 365 / 372 • Jonsered 2165 / 2171	4,95
<b>PB990083</b>	(14) Sinfin engrase Ref.537252601	Husqvarna: 455 / 460 / 461 Jonsered CS2255	4,50
<b>PB990084</b>	(15) Sinfin engrase Ref.505200801	Husqvarna: 545 / 550 / 555 / 560 Jonsered: 2252 / 2253 / 2258 / 2260	5,50

## RODAMIENTOS Y RETENES CIGÜEÑAL ADAPTABLES



<b>C26-015</b>	Rodamiento 12x28x8 6001	Camon: C26/C26PRO/TCS2600 • Zenoah: G2500	2,96
<b>C26-016</b>	Retén 12x22x5	Camon: C26/C26PRO/TCS2600 • Zenoah: G2500	2,90
<b>C26-017</b>	Retén 12x8x6	Camon: C26/C26PRO/TCS2600 • Zenoah: G2500	2,96
<b>C45-ZJB054</b>	Rodamiento 15x35x11 6202	Camon: C41/TCS4100 • Zenoah: G3800 / BG520A	3,97
<b>C37-ZJA016</b>	Retén 12x32x5,5	Camon: C41/TCS4100 • Zenoah: G3800	2,95
<b>C37-ZJA017</b>	Retén 12x22x7	Camon: C41/TCS4100 • Zenoah: G3800	2,95
<b>C45-ZJB054</b>	Rodamiento 15x35x11 6202	Camon: C45/C50/C62/TCS4600/TCS5000 • Zenoah: G455	3,97
<b>C45-ZJB053</b>	Retén 15x28x4,5	Camon: C45/C50/TCS4600/TCS5000 • Zenoah: G500	2,50
<b>C45-ZJB094</b>	Retén 15x35x4,5	Camon: C45/C50/C62/TCS4600/TCS5000 • Zenoah: G500	2,90
<b>C62-A033</b>	Retén 13x20x4,5	Camon: C62 • Zenoah: G621	3,25
<b>ZJA014</b>	Rodamiento 10x26x8 6000	Camon: GJB-25D	2,90
<b>ZJA019</b>	Retén 10x20x5	Camon: GJB-25D	1,98
<b>ZJA011</b>	Retén 10x26x5	Camon: GJB-25D	1,90
<b>SH2320088162</b>	Retén cigüeñal 11,7x22x7	Camon: CG330-E/CG430-E/CG260E	2,15
<b>SH2310001557</b>	Rodamiento cigüeñal 6201	Camon: CG330-E/CG430-E/CG260E	2,15
<b>SH2320001284</b>	Retén cigüeñal 30x14,7x7	Camon: CG430-E / 3CG430	3,95
<b>SH2310001563</b>	Rodamiento cigüeñal 6202	Camon: CG430-E	3,95

**RODAMIENTOS ADAPTABLES CAMON - PARTNER - HUSQVARNA - MCCULLOCH - JONSERED - MA.RI.NA**

(1)

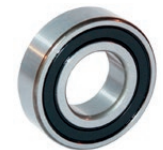
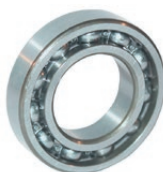
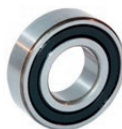

REFERENCIA	DESCRIPCIÓN	ALTURA MM	Ø EXT.	Ø INT.	MODELOS	P.V.P SIN I.V.A.
MA038226	1. Rodamiento aleta	12	26	12	Castelgarden Stihl - Viking	2,69
MA038227	1. Rodamiento aleta	12	27	12	Castelgarden	3,75
P531213828	1. Rodamiento aleta	13	26	13	Marazzini - Partner Husqvarna - McCulloch Jonsered	6,98
PB990200	1. Rodamiento aleta	8,5	28,5	11	Universal	2,95
PB990201	1. Rodamiento aleta	10,6	28,9	12,8	Honda / Kaaz	2,70
PB990202	1. Rodamiento aleta	8	28,5	13	Universal	2,95
PB990203	1. Rodamiento aleta	11,5	29	13	Masport	4,95
PB990204	1. Rodamiento aleta	11	35	13	Universal	2,95
PB990205	1. Rodamiento aleta	11,5	37	15	Honda	2,95
PB990206	1. Rodamiento aleta	11	35	19	MTD/Snapper/Toro	1,19
MA038026	Rodamiento	8	26	10	6000 2RS	5,70
PU0306010004	Rodamiento Pubert	8	28	12	6001 2RS	3,70
MA038030	Rodamiento	9	30	10	6200 2RS	5,36
PB62032RSC3	Rodamiento rueda	12	40	17	6203 2RS C3	4,95
ML210554	Rodamiento	8	22	7	608 2RS	3,64
ML140268	Rodamiento	7	24	9	609Z	4,44
ML210560	Rodamiento	7	24	9	609 2RS	3,83
PU0306010003	Rodamiento Pubert	8	26	10	6000ZZ	1,60
PU0306010034	Rodamiento Pubert	8	26	10	6000 2RS	1,85
ZJB013	Rodamiento	8	28	12	6001 2Z	2,50
PU0306010006	Rodamiento Pubert	10	35	17	6003 2RS	9,75
PU0306010007	Rodamiento Pubert	12	42	12	6004 2RS	3,90
PU0306010069	Rodamiento Pubert	13	55	3	6006 2RS	4,50
PU0306010009	Rodamiento Pubert	9	30	10	6200ZZ	3,25
ML012649	Rodamiento	10	32	12	6201ZZ	8,43
ML140474	Rodamiento	9	32	15	6202 ZZ	5,30
SH2310002121	Rodamiento	11	35	15	6202 2RS	2,50
PU0306010013	Rodamiento Pubert	12	40	17	6203 2RS	7,75
PU0306010015	Rodamiento Pubert	14	47	20	6204 2RS	3,95
PU0306010017	Rodamiento Pubert	15	52	25	6205 2RS	8,75
PU0003000059	Rodamiento Pubert	16	62	30	6206 C3	7,70
PU0306010020	Rodamiento Pubert	17	62	25	6305 2RS	6,95
ZJB017	Rodamiento	7	37	25	6805 ZZ	2,98

**RETENES ADAPTABLES**

	REFERENCIA	DESCRIPCIÓN	MODELO	P.V.P SIN I.V.A.
(1) 	<b>PB456961</b>	(1).-Retén 15x26x6 Ref. 503260204	Partner: B440 · Husqvarna: 61/66/266	4,95
	<b>PB456962</b>	(2).-Retén 15,6x28x5,2 Ref. 503260205	Partner: K950 · Husqvarna: 281/288	4,95
(2) 	<b>PB456963</b>	(3).-Retén 18,4x26,4x3,6 Ref. 503260301	Husqvarna: 362/365/371/372	5,95
	<b>CWT9900010</b>	(4).-Retén cigüeñal 25x41,25x6	GX160	2,96
(3) 	<b>CWT9900012</b>	Retén fresa 38x55x8	WMX720	3,95
	<b>PB382507</b>	Retén cigüeñal 38x25x7		2,95
(4) 	<b>2031600016N</b>	Retén cigüeñal 25x38x7	DYM1626CQ	5,95
	<b>2031600031N</b>	Retén cigüeñal 17x30x6	DYM1661FB	3,90
(10) 	<b>2031600060N</b>	Retén cigüeñal 22x35x7	DYM1661FB / DYM1626CQ	4,95
	<b>SH2320003494</b>	(10).-Retén cigüeñal 12x28x7	SG250	1,98
(11) 	<b>CWT0303100</b>	(11).-Retén DX 25x41x9,5/13	WM500	4,95
	<b>CWT0303200</b>	(11).-Retén SX 25x52x9,5/13	WM500	5,28
(13) 	<b>CWT0303400</b>	Retén 12x22x6	WM500	1,91
	<b>IN90164100</b>	(13).-Retén SX 25x62x10	Interpum	4,15
(14) 	<b>PU0341000059</b>	14. Retén carter	Motozadas PUBERT/HONDA	5,98

**ASAS Y AMORTIGUADORES ADAPTABLES**

<b>C26-148</b>	1. Asa tubular SX	Zenoah: G2500 · Camon: C26/C26PRO/TCS2600	8,71
<b>C26-153</b>	2. Asa superior DX	Zenoah: G2500 · Camon: C26/C26PRO/TCS2600	13,95
<b>C37-ZJB001</b>	Asa tubular SX	Zenoah: G3800 · Camon: C37/C41/TCS4100	16,90
<b>TCS4100A-66</b>	Asa deposito gasolina + aceite	Zenoah: G3800 · Camon: C37/C41/TCS4100	21,00
<b>C45-ZJA074</b>	5. Asa tubular SX	Zenoah: G455/G500 · Camon: C45/C50/TCS4600/TCS5000	17,00
<b>C45-ZJA051</b>	Asa deposito gasolina + aceite	Zenoah: G455/G500 · Camon: C45/C50/TCS4600/TCS5000	19,75
<b>C62-B074</b>	Asa tubular SX	Zenoah: G621 · Camon: C62	19,00
<b>C62-B051</b>	Asa trasera DX	Zenoah: G621 · Camon: C62	39,00
<b>C26-105</b>	Amortiguador muelle	Zenoah: G2500 · Camon: C26/C26PRO/TCS2600	1,10
<b>C26-150</b>	10. Amortiguador goma	Zenoah: G2500 · Camon: C26/C26PRO/TCS2600	3,95
<b>C26-163</b>	Tapa amortiguador goma	Zenoah: G2500 · Camon: C26/C26PRO/TCS2600	1,50
<b>C26-149</b>	Lona tirante	Zenoah: G2500 · Camon: C26/C26PRO/TCS2600	1,95
<b>C37-ZJB029</b>	13. Amortiguador goma + lona	Zenoah: G3800 · Camon: C37/C41/TCS4100	1,39
<b>C37-ZJB030</b>	14. Amortiguador goma	Zenoah: G3800 · Camon: C37/C41/TCS4100	1,95
<b>C37-ZJB035</b>	15. Amortiguador muelle	Zenoah: G3800 · Camon: C37/C41/TCS4100	1,95
<b>C37-ZJB069</b>	16. Amortiguador muelle	Zenoah: G3800 · Camon: C37/C41/TCS4100	1,95
<b>PB440023</b>	17. Amortiguador 502203203	Husqvarna 225RD / 227RD / 332R	3,95
<b>PB440035</b>	18. Amortiguador 506014701	Husqvarna 41 / 45 / 49	4,90
<b>PB440039</b>	19. Amortiguador 545063101	Husqvarna 230 / 235 / 236 / 240	4,25
<b>PB440032</b>	20. Amortiguador 503898301	Husqvarna 340 / 345 / 346 / 350 / 351 / 353 / 435	4,90
<b>PB440036</b>	21. Amortiguador 544101201	Husqvarna 445 / 450	5,95
<b>PB440034</b>	22. Amortiguador 504795601	Husqvarna 325LDX / 327LDX / 327LX 327RDX / 327RDX / 435 / 440E	4,90
<b>PB440038</b>	23. Amortiguador 545033901	Husqvarna 230 / 235 / 235E / 236 / 236E 240 / 240E	4,90
<b>PB440033</b>	24. Amortiguador 503923301	Husqvarna 357XP / 359	6,95
<b>PB440037</b>	25. Amortiguador 545033801	Husqvarna 230 / 235 / 236 / 240	4,90
<b>PB990000</b>	26. Amortiguador 503528702	Husqvarna 394/395 · Jonsered 2186	5,95
<b>PB890000</b>	27. Amortiguador 503637503	Husqvarna 362/365/371/372/374/375	4,90

## ASAS Y AMORTIGUADORES ADAPTABLES

REFERENCIA	DESCRIPCIÓN	MODELO	P.V.P SIN I.V.A.
 (1)	<b>C45-ZJB025</b> 1. Amortiguador muelle	G455/G500/C45/C50/TCS4600/TCS5000	1,50
 (2) (3)	<b>C45-ZJA052</b> 2. Amortiguador goma superior	G455/G500/C45/C50/TCS4600/TCS5000	1,50
 (4)	<b>C45-ZJB059</b> 3. Amortiguador goma inferior	G455/G500/C45/C50/TCS4600/TCS5000	2,90
 (5)	<b>C62-B045</b> 4. Amortiguador SX trasero	C62 · Zenoah G621	2,95
 (6)	<b>C62-B046</b> 5. Amortiguador DX trasero	C62 · Zenoah G621	2,10
 (7)	<b>C62-B061</b> 6. Amortiguador goma superior	C62 · Zenoah G621	3,95
 (8)	<b>C62-B060</b> 7. Tapa amortiguador goma	C62 · Zenoah G621	0,90
 (9)	<b>C62-B069</b> Amortiguador goma inferior	C62 · Zenoah G621	2,10
 (10)	<b>C62-B071</b> Tapa amortiguador goma	C62 · Zenoah G621	1,30
 (11)	<b>ZJC004</b> Amortiguador muelle delantero	GJB-25D	2,10
 (12)	<b>ZJC009</b> Amortiguador muelle trasero	GJB-25D	2,50
 (13)	<b>ZJC010</b> Tapa amortiguador muelle	GJB-25D	1,50
 (14)	<b>PB456715</b> 13. Amortiguador/Ref.501530501	Husqvarna: 44/55/61/162/266/444	4,20
 (15)	<b>PB456716</b> 14. Amortiguador /Ref.501773401	Husqvarna: 61/66/266/268/272/380	3,75
 (16)	<b>PB456717</b> 15. Amortiguador/Ref.501699401	Jonsered: 670 · Husqvarna: 61/268/266	3,75
 (17)	<b>PB456718</b> 16. Amortiguador/Ref.501628701	Jonsered: 670 · Husqvarna: 61/268/266	3,95
 (18)	<b>PB456720</b> 17. Amortiguador/Ref.501773501	Husqvarna: 61/66/266/268/272	4,75
 (19)	<b>PB456721</b> 18. Amortiguador/Ref.501763902	Husqvarna: 50/51/55	3,90
 (20)	<b>G006</b> 21. Muelle inferior delantero y trasero EM · Ref.506014601	Partner: 410/411/510/511 Husqvarna · Jonsered	2,15
 (21)	<b>G005</b> 22. Muelle superior DX EM Ref.506014701	Partner: 410/411/510/511 Husqvarna · Jonsered	2,95
(22)	<b>G590</b> 23. Kit 3 muelles Ref. 545006036	Partner: 351/370/420/352/401/422 Jonsered 2135/2137/2138	6,95
(23)	<b>G591</b> 24. Amortiguador generador espárrago ø 8	WM2500	6,90
(24)	<b>G592</b> 25. Amortiguador generador espárrago ø 10	WM2500	6,90
(25)	<b>G593</b> 26. Amortiguador generador espárrago ø 10	WM5500	7,90

**ROPA DE PROTECCION Y ACCESORIOS**

	REFERENCIA	DESCRIPCIÓN	P.V.P SIN I.V.A.
(1) 	<b>ML420282</b>	(1) Casco CPL Maruyama: Protectores acústicos y visor malla. Normativa EN 397, EN 352-3, EN 166, EN 1731	63,72
(2) 	<b>PB453576</b>	(2) Casco forestal con protección auditiva y visera de rejilla	32,90
(2A) 	<b>PB1504120</b>	(2A) Casco forestal con protección auditiva y visera de rejilla	34,90
(3) 	<b>PB453515</b>	(3) Visera de protección con rejilla Normativa EN 352-3, EN 1731	8,95
(4) 	<b>PB400515</b>	(4) Rejilla de recambio 30cm	4,95
(5) 	<b>PB400514</b>	(4) Rejilla de recambio 39cm	4,95
(4A) 	<b>PB400516</b>	(4A) Plexiglas de recambio	4,95
(6) 	<b>G048</b>	(5) Kit visera con rejilla metálica + plexiglas + Cascos protectores CE	19,75
(7) 	<b>PB970013</b>	(6) Visera protección. Malla de PVC EN166B	10,75
(8) 	<b>PB400530</b>	(6A) Rejilla y plexiglas recambio EN 166B	6,25
(8A) 	<b>G049</b>	(7) Visera de protección con rejilla + plexiglas Ajustable en la cabeza. Normativa EN1731	14,95
(13) 	<b>PB455309</b>	(8) Visera de protección PVC Normativa EN166	8,95
(16) 	<b>PB400519</b>	(8A) Plexiglas de recambio	5,90
(17) 	<b>ML420280</b>	(13) Auriculares 29db Maruyama	11,96
(18) 	<b>PB453321</b>	(16) Auriculares ergonómicos 25db. 155 g	5,95
(20) 	<b>PB455310</b>	(17) Auriculares ergonómicos 30db. 225 g	14,90
(21) 	<b>PB455307</b>	(18) Gafas protectoras clara antivaho EN166	3,95
(23) 	<b>G725</b>	(19) Kit protección gafas + guantes y auriculares	6,95
	<b>TC101469</b>	(20) Gafas protección Yellow. Normativa EN 166 Con cristales amarillos	4,95
	<b>TC101470</b>	(21) Gafas protección Smoked. Normativa EN 166 Con cristales UV para mejor visibilidad en condiciones de sol	8,75
	<b>PB023456</b>	(23) Gafas de protectoras con 4 orificios de ventilación CE. Normativa EN 166	2,90

## ROPA DE PROTECCION Y ACCESORIOS



REFERENCIA	DESCRIPCIÓN	P.V.P SIN I.V.A.
G079	(1) Chaps anticorte (Zahones) EM. Talla única. Sin culera. Normativa EN 381-5, EN 340. Clase 1. 20m/s	99,00
G081	(2) Peto Anticorte - 20M/S Normativa EN 381-5, EN340 Modelo A Clase 1 Talla M (SIP Protección)	129,75
G082	(2) Talla L (SIP Protección)	129,75
G056	(3) Talla M. Pantalón anticorte Clase 1.20m/s	114,00
G057	(3) Talla L	114,00
G055	(4) Chaps anticorte CE (Talla L)	90,75
G053	(4) Chaps anticorte CE (Talla S)	90,75
PB991194	(5) Pantalón anticorte Clase 1. 20 m/s (Talla S) (SIP Protección)	109,00
PB991195	(5) Talla M (SIP Protección)	109,00
PB991196	(5) Talla L (SIP Protección)	109,00
PB991197	(5) Talla XL (SIP Protección)	109,00
G500S	(7) Pantalón desbroce Talla S	69,75
G500M	(7) Pantalón desbroce Talla M	69,75
G500L	(7) Pantalón desbroce Talla L	69,75
TC000010	(7A) Pantalón desbroce Talla única	54,00
G063	(8) Pantalón anticorte Silvicultura EcoFlex Class 1 Talla S (SIP Protección)	249,00
G064	(8) Pantalón anticorte Silvicultura EcoFlex Class 1 Talla M (SIP Protección)	249,00
G065	(8) Pantalón anticorte Silvicultura EcoFlex Class 1 Talla L (SIP Protección)	249,00
G066	(8) Pantalón anticorte Silvicultura EcoFlex Class 1 Talla XL (SIP Protección)	249,00
G067	(8) Pantalón anticorte Silvicultura EcoFlex Class 1 Talla XXL (SIP Protección)	249,00
PB9809700	(9) Tirantes	24,35

**ROPA DE PROTECCION Y ACCESORIOS**

REFERENCIA	DESCRIPCIÓN	P.V.P SIN I.V.A.
G070	(1A) Chaqueta Anticorte Normativa EN 381-11 Clase 1 Talla 46/48 (S) (SIP Protección)	179,00
G071	(1A) Talla 50/52 (M) - (SIP Protección)	179,00
G072	(1A) Talla 54/56 (L) - (SIP Protección)	179,00
G073	(1A) Talla 58/60 (XL) - (SIP Protección)	179,00
PB361639	(2) Par botas Anticorte N°39 Clase 1 20m/s	199,75
PB361640	(2) Par botas Anticorte N°40 Clase 1 20m/s	199,75
PB361641	(2) Par botas Anticorte N°41 Clase 1 20m/s	199,75
PB361642	(2) Par botas Anticorte N°42 Clase 1 20m/s	199,75
PB361643	(2) Par botas Anticorte N°43 Clase 1 20m/s	199,75
PB992541	(3) Par botas Anticorte Normativa EN 345-2 Clase 2 N° 41	129,00
PB992542	(3) N° 42	129,00
PB992543	(3) N° 43	129,00
9AGAH41	(4) Zapato alto de seguridad CE - N° 41 EN S3	39,90
9AGAH42	(4) Zapato alto de seguridad CE - N° 42 EN S3	39,90
9AGAH43	(4) Zapato alto de seguridad CE - N° 43 EN S3	39,90
PB42100M	(5) Mono blanco Talla M (un solo uso)	11,75
PB42100L	(5) Mono blanco Talla L (un solo uso)	11,75
PB42100XL	(5) Mono blanco Talla XL (un solo uso)	11,75
PB4520L	(6) Mono pulverización. Talla L Protección tipo 5 y 6. Normativa EN1073-2, EN1149-1, EN13034, EN13982	13,95
PB4520XL	(6) Mono pulverización. Talla XL Protección tipo 5 y 6. Normativa EN1073-2, EN1149-1, EN13034, EN13982	13,95
PB004251	(7) Mascarilla buconasal FFA1P2D Normativa EN405:2001+A1:2009	39,75
PB054200	(8) Mandil cuero	36,95
PB603504	(9) Mandil PVC 120x90	18,75
PB940650	(10) Cuña abridora 2000g	21,75
PB015151	(12) Cuña 12 g. PVC 70x140mm	4,90
PB015152	(12) Cuña 22 g. PVC 70x190mm	7,95
PB015153	(12) Cuña 36 g. PVC 77x270mm	13,75
PB120740	(13) Afilador de hachas y cuchillos	26,95



## ROPA DE PROTECCION Y ACCESORIOS



















REFERENCIA	DESCRIPCIÓN	P.V.P SIN I.V.A.
G9203	(15) Hacha 24". 1,7 kg (70 cm)	39,75
G9204	(14) Hacha 34". 2,5 kg (90 cm)	41,75
PB10370	(16) Hacha 370mm - 0,68 Kg	24,75
PB990099	(17) Cinta métrica 15 metros · 586997501	59,75
PB990059	(18) Gancho troncos	22,75
PB990060	(19) Palanca derribo y gancho 75cm	69,75
PB990058	(20) Calibre árboles 500 mm	49,95

## BIDONES Y DEPÓSITOS



REFERENCIA	DESCRIPCIÓN	CLASE	P.V.P SIN I.V.A.
PB030000	(1) Embudo + filtro	Profesional	43,75
TC101078	(2) Válvula gasolina		8,90
TC101079	(3) Válvula aceite EM		4,90
TC101080	(4) Tapón con soporte EM		5,95
TC101077	(5) Depósito 6 L + 2,5 L con válvulas anti-derrame. Incluye protección contra rebose	UN 3H1/Y/200	22,75
PB453600	(6) Embudo + filtro	Estandar	4,15
PB819800	(9) Boquilla autostop para bidón. PB008114		19,95
PB484135	(10) Bidón met. gasolina 20 L	UN 3A1/Y/100/10	46,75
PB486531	(10) Bidón met.o gasolina 10 L	UN 3A1/Y/100/10	42,75
PB455780	(10) Bidón met. gasolina 5 L	UN 3A1/Y/100/10	31,80
PB031477	(11) Boquilla con soporte de fijación para depósitos metálicos		13,95
PB813530	(12) Bidón PVC gasolina 20L	UN 3H1/Y1.2/150	17,95
PB812873	(12) Bidón PVC gasolina 10L	UN 3H1/Y1.2/150	13,95
PB811560	(12) Bidón PVC gasolina 5L	UN 3H1/Y1.2/150	9,95

**ARNES DESBROZADORAS**

	REFERENCIA	DESCRIPCIÓN	MODELO	P.V.P SIN I.V.A.
(1) 	SH2320101489	1. Arnés simple	QJB270	6,75
(2) 	PB000880	2. Arnés profesional con protección lumbar		32,75
(3) 	Ai751580	3. Arnés simple		6,90
(4) 	SH2320096617	4. Arnés doble	CG260-E/CG330-E/CG430-E	9,95
(5) 	SH2320104027	5. Arnés doble profesional	3GC420/3GC520 CG415Q33 / CG415Q52	26,90
(6) 	ML228086	6. Arnés doble Maruyama	BC5020/BC421H/BC501H BC4321H / BC5021H	47,79
(7) 	ML234477	7. Arnés doble Maruyama con protección lumbar	BCV5020 / BCV5021	129,31
(8) 	ML226490	8. Arnés mochila Maruyama	M50BKC/BKC5020 BCK5021RS	115,34
(9) 	A800201	9. Arnés doble	Universal	12,75
(10) 	G5006	10. Arnés cortasetos	(no profesional)	189,75
(11) 	SH2320109873	11. Arnés (1 unidad)	EB500 / EB800-E	7,39
(12) 	PB007160	12. Gancho arnés de repuesto		1,90
(13) 	SH19000127	13. Gancho arnés tubo	Ø 28mm	1,98
(14) 	SH2320003143	13. Gancho arnés tubo	Ø 26mm	1,97
(15) 	ML217850	14. Soporte arnés tubo	Ø 28mm	4,84
(15A) 	ML220533	15A. Arnés simple	MC2630/MC321/TTP2630/ PP2430/BC2300/MX24	13,05
(16) 	Ai752260	15. Arnés PS2240/GA4040		68,95
(17) 	SH2320024134	16. Arnés doble	BG431/BG520A	29,75
(18) 	SH2320101489	17. Arnés	QJB270	6,75
	PB9101344	18. Arnés para zurdos		29,75

## GUANTES DE TRABAJO ADAPTABLES

	REFERENCIA	DESCRIPCIÓN	MODELO	P.V.P SIN I.V.A.
(1) 	<b>PB991509</b> (TALLA L) <b>PB991510</b> (TALLA XL)	(1) Par de guantes anticorte (protección mano izquierda)	EN 381-7 Clase 0	22,75
(2) 	<b>PB101931</b>	(2) Par de guantes anticorte · Talla 9 L (protección en las dos manos)	EN381-7 TYPE A Clase 1	54,95
	<b>PB101932</b>	(2) Par de guantes anticorte · Talla 10 XL (protección en las dos manos)		54,95
(3) 	<b>ML466563</b>	(3) Par de guantes anticorte (protección mano izquierda) Maruyama	EN381-7 TYPE A Clase 1	59,75
(4) 	<b>PB9809490</b>	(4) Mangas antebrazo	Anticorte 20 m/s Clase 1	38,75
(5) 	<b>PB9808204</b>	(5) Par de guantes PVC	Líquidos / Ácido	4,98
(6) 	<b>PB014420</b>	(6) Protegepiernas (par)	Espinillera de polietileno	16,45
(7) 		(7) Par de guantes para trabajos de precisión (gran tacto) Talla L		
(8) 	<b>G725</b>	(8) Kit protección	Guantes, gafas y auriculares	6,95
(9) 	<b>PB9808311</b>	(9) Chaleco reflectante CE	Talla única	4,39

**PROTECTORES HILO DESBROZADORAS**

	REFERENCIA	DESCRIPCIÓN	MODELO	P.V.P. SIN I.V.A.
 (1)	<b>PB1620785</b>	Protector hilo Husqvarna Adap. Ref:537332601	Husqvarna:143R/235R/236R/241R 333R/335R/535R	18,50
 (2)	<b>SH2320104021</b>	2. Protector hilo	3GC430/3GC520	13,96
 (3)	<b>SH43001122</b>	3. Protector hilo Ø 28mm	Camon: CG260-E/CG330-E/CG430-E BG431 7 Q33 / Q43	13,75
 (19)	<b>SH2320011178</b>	19. Soporte Ø 26mm	CG260/CG330E/CG430E/BG431	1,90
 (19)	<b>SH2320062240</b>	19. Soporte Ø 28mm	CG260/CG330E/CG430E/BG431	1,90
 (4)	<b>TC005801</b>	4. Protector hilo universal	Tubo: 24 / 26 / 28mm	6,96
 (5)	<b>ML220246</b>	5. Protector hilo Maruyama	M23CS-RS / BGL2250	6,96
 (9)	<b>ML228303</b>	9. Protector hilo Maruyama (sin faldilla)	BKC5020/BC420H/BC43020H/BC5020H	17,55
 (10)	<b>ML230748</b>	10. Faldilla protector hilo (sin cuchilla)	BKC5020/BC420H/BC43020H/BC5020H	6,04
 (15)	<b>ML234593</b>	15. Protector hilo Maruyama (sin faldilla) BCV5020	(sin faldilla) BCV5020	35,76
 (16)	<b>ML231989</b>	16. Faldilla protector hilo (sin cuchilla) BCV5020 / BCV5021	(sin cuchilla) BCV5020 / BCV5021	11,95
 (17)	<b>ML230789</b>	17. Kit cuchilla + Tornillo	Protector hilo Maruyama	5,04
 (17)	<b>503798801</b>	17. Cuchilla	Protector hilo Husqvarna	3,95
 (18)	<b>TC005801</b>	18. Protector hilo universal (con cuchilla)	Tubo: 24 / 26 / 28 mm	7,95

## LLAVES DE BUJÍAS ADAPTABLES



REFERENCIA	DIMENSIONES	DESCRIPCIÓN	PARA MOTORES	P.V.P SIN I.V.A.
PB453216	(1) 13 x 16	140 x 70	Homelite · Landon McCulloch	2,30
PB453217	(2) 10 x 19	140 x 90		2,10
PB453186	(3) 13 x 19	140 x 85	Partner · Husquarna Jonsered	2,40
PB015170	(4) 17 x 19	140 x 64	CG330-E / CG430-E	3,12
PB453151	(5) 19 x 21	Con terminal hembra de 12 mm	□ 11 mm	2,53
PB453392	(6) 19 x 21	130 x 80	□ 9,5 mm	1,95
PB453390	(7) 19	Con punta Torx T25	Sthil	3,79
PB9302498	(7) 19	Con punta Torx T27	Sthil	2,19
PB9302493	(8) 16 x 21	L = 203 mm	Briggs & Stratton OHV	3,15





## HERRAMIENTAS DE TALLER



REFERENCIA	DESCRIPCIÓN	P.V.P SIN I.V.A.
PB2068162	(1). Sellador de tornillos 50ml	45,95
PB404910	(2). Loctite instantáneo 5g	11,95
PB992002	(3) Kit manómetro + Pistola + Manguera M12X1	37,55
PB9206910	(4) Manómetro carburadores y cilindros 2T	49,95
PB999913	Rectificador cigueñales cortacéspedes	277,75
PB55003	Cinta métrica, 3 metros	3,95
PB55005	Cinta métrica, 5 metros	4,95
PB990095	Calibre 150 mm	36,10
PB990092	Tornillo de Hierro fundido 4" / 100 mm	99,75
PB9206050	Limpiador ultrasonido 2L / 220V / 50W	282,35
PB9202596	Botella 1L Limpiador especial	26,59

## HERRAMIENTAS DE TALLER ADAPTABLES: CAMON, PARTNER, JONSERED, HUSQVARNA, MCCULLOCH



REFERENCIA	DESCRIPCIÓN	REFERENCIA ORIGINAL	P.V.P SIN I.V.A.
TC900001	1.- Llave Torx TX25	502712701	25,75
TC900002	2.- Llave Torx TX30	502713101	28,75
TC900003	3.- Llave Allen 3 mm	504900004	8,95
TC900004	4.- Llave Allen 4 mm	504900002	9,75
TC900005	5.- Llave Allen 5 mm	504900003	12,75
TC900006	6.- Llave Allen 6 mm	504900001	13,75
TC900007	7.- Llave Allen 3/16"	502505701	13,75
TC900008	8.- Destornillador Torx TX20	502516701	16,75
TC900009	9.- Llave vaso 8 mm	505381308	27,95
SH2320112908	10.- Destornillador ajuste Carburador		6,95
TC900011	11.- Destornillador ajuste Carburador	530035560 	8,70
Ai500-510	11.- Destornillador ajuste Carburador		5,90
G496	11.- Destornillador ajuste Carburador		5,95
G498	11.- Destornillador ajuste Carburador		5,50
G495	12. Kit 4 Llaves ajuste Carburador		19,95
G494	13. Kit 11 Llaves	Carburador	29,95

## ÚTILES TALLER



GA1235	1A.- Maletín Afilado Universal	Forestal	49,75
TC900012	1.- Trabador pistón metálico	Kit 14/18mm	6,75
PB453754	1.- Trabador pistón PVC	Ø14mm	2,90
TC900013	2.- Útil Carter-Cigüeñal	502516101	65,90
TC900014	3.- Kit montaje pistón	502507001	9,95
PB04096	4.- Kit reparación	Helicoides M14x1,25	109,75
TC900016	5.- Extractor rodamientos	504909001	165,95
TC900017	6.- Bujía de prueba	502711301	12,75
PB015068	7.- Comprobador corriente	Para bujías	15,75
PB040305	8.- Extractor embrague	Motosierras 25cc	13,75
PB040306	9.- Extractor embrague	Motosierras 62cc / 65cc	24,95
PB523051	10.- Cuentarevoluciones	Digital	89,75
PB453219	11.- Pistola engrasadora piñones	Universal	7,75
TC900022	12.- Extractor de aceites	531025621 / 200 ml	11,95

## KIT CUCHILLAS UNIVERSALES CORTACÉSPEDES ADAPTABLES



REFERENCIA	DESCRIPCIÓN	A	B	P.V.P SIN I.V.A.
<b>G750</b>	Cuchilla universal cortacéspedes	38 cm	25,4	15,95
<b>G751</b>	Cuchilla universal cortacéspedes	40 cm	25,4	16,95
<b>G752</b>	Cuchilla universal cortacéspedes	43 cm	25,4	17,95
<b>G753</b>	Cuchilla universal cortacéspedes	45 cm	25,4	18,75
<b>G754</b>	Cuchilla universal cortacéspedes	48 cm	25,4	18,95
<b>G755</b>	Cuchilla universal cortacéspedes	50 cm	25,4	19,75
<b>G756</b>	Cuchilla universal cortacéspedes	53 cm	25,4	19,95

## CUCHILLAS CORTACÉSPEDES Y TRACTORES CORTACÉSPEDES ADAPTABLES MTD



REFERENCIA	DESCRIPCIÓN	A	B	C	D	REF. ORIGINAL	P.V.P SIN I.V.A.
<b>G800</b>	Cuchilla 4E Mulching	457	4E	7,5	63,5	742-0738	15,90
<b>G801</b>	Cuchilla 4E Con aleta	455	4E	8	63,5	742-0818	23,75
<b>G802</b>	Cuchilla 4E Con aleta	515	4E	7,5	63,5	742-04364	29,75
<b>G803</b>	Cuchilla 6E Con aleta	762	6E	8,5	63,5	742-04058	27,95
<b>G804</b>	Cuchilla 6E DX con aleta	467	6E	-	-	742-0672	18,95
<b>G805</b>	Cuchilla 6E SX con aleta	467	6E	-	-	742-0673	18,95
<b>G806</b>	Cuchilla 6E DX con aleta	540	6E	-	-	742-0670	18,95
<b>G807</b>	Cuchilla 6E SX con aleta	540	6E	8	-	742-0671	23,75
<b>G808</b>	Cuchilla DX con aleta	520	10,5	8	63,5	742-0608	19,75
<b>G809</b>	Cuchilla SX con aleta	520	10,5	8	63,5	742-0607	18,75
<b>G810</b>	Cuchilla (salida lateral)	490	6E	8	63,5	742-0610A	15,75
<b>G819</b>	Cuchilla (salida lateral)	540	6E	8	63,5	742-0674	12,95

## CUCHILLAS CORTACÉSPED CAMON - MA.RI.NA - STERWINS - VIKING - AKITA

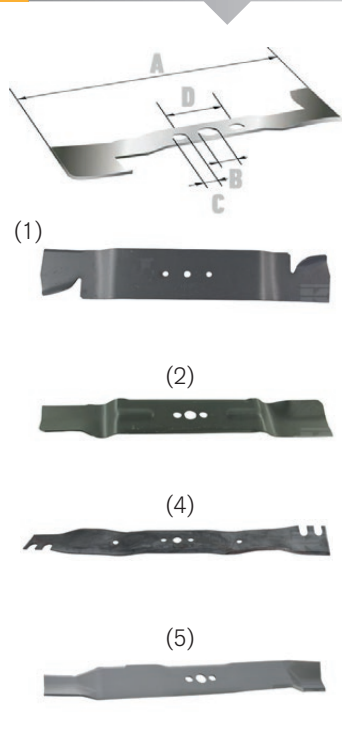

REFERENCIA	DESCRIPCIÓN	A	B	C	D	MODELOS	P.V.P SIN I.V.A.
<b>PB1108732</b>	1. Cuchilla	315	18	8	45	MA.RI.NA / Viking	12,45
<b>MA040010</b>	2. Cuchilla	385	18	8	45	SP40E	26,95
<b>PB1100093</b>	3. Cuchilla	460	10	8	65	SP46ST/SP46SH GT47/46LSC	25,75
<b>PB406324</b>	4. Cuchilla Ref. 045013	430	10	8	65	GT45 / GT45SH	22,75
<b>MA051013</b>	5. Cuchilla	501	16	8	65	GX51 SB	41,95
<b>PB1100094</b>	6. Cuchilla	510	10	8	65	MX52SB / MX52SH	27,95
<b>MA056012</b>	7. Cuchilla con aleta	525	16	8	65	GT56SB / GT56SH	53,75
<b>PB1106581</b>	8. Cuchilla con aleta	673	18,5	9	65	Piccolo (MEP10330500)	68,95
<b>PB1100096</b>	9. Cuchilla	560	10	8	65	GT57 / HT57 / MX57	45,85
<b>PB1108778</b>	10. Cuchilla	508	10	8	65	GT52/GT53/GT54	19,95
<b>MA057013</b>	11. Cuchilla	560	10	8	65	GT57/HR57	45,35

**CUCHILLAS CORTACÉSPEDES ADAPTABLES: PARTNER - HUSQVARNA - MARAZZINI - JONSERED - AYP**

REFERENCIA	DESCRIPCIÓN	A	B	C	D	MODELOS	P.V.P SIN I.V.A.
PB405663	1. Cuchilla Ref. EM 516506404	456	10,2	8	65	146EL/146CD 147CD/ROYAL 47	23,75
PB405664	1. Cuchilla Ref. EM 516494304	530	10,2	8	65	153CD/ROYAL53S ROYAL53SE	33,95
PB410035	2. Cuchilla 581188910 / 10122770	460	17	12	45	Marazzini - Partner: 1746E/3546S/4046SD 4046SDX/4546SDX 4546SDXE/P46 500CD/6046SDX	17,95
PB1100194	4. Cuchilla	530	16	10	47	Marazzini - Partner: 5553D/6553D/P53-675DWA P53-160DW/R53SV / R152SV	13,75
PB1108554	5. Cuchilla	500	17	12	45	Marazzini - Partner: 4551SDX/6051CD 6051CDTX	27,75
PB1108555	5. Cuchilla 10141770/581188610	530	17	12	40	Marazzini - Partner: 6053CD/PN 9538783-08	19,90

**CUCHILLAS TRACTORES ADAPTABLES: PARTNER - HUSQVARNA - JONSERED - MCCULLOCH - CASTELGARDEN**

REFERENCIA	DESCRIPCIÓN	A	B	C	D	MODELOS	P.V.P SIN I.V.A.
PB406228	Cuchilla 460 mm 5E Ref. EM 532138496 Superf. corte: 36"/92cm	460	5E	-	-	Partner: P115/P11-92 P12-90E/P12-90EH P13-90EH - Husqvarna: LT12/LT130/LTH130	11,95
PB406232	Cuchilla 535 mm 5E Ref. EM 532138971	535	5E	-	-	Partner: 14-105E/15-105E 16-105EH/P160H	13,95
PB406229	Cuchilla 490 mm 5E Ref. EM 532138497	490	5E	-	-	Partner:12-95E/P12597 Husqvarna: LT960/LT125 LT100/LT120/LT12	14,75

**CUCHILLAS ADAPTABLES TORO - FERRIS - SNAPPER**

REFERENCIA	DESCRIPCIÓN	A	B	C	D	MODELOS	P.V.P SIN I.V.A.
PB1103363	Cuchilla Ref. Orig.1633485	457	15,9	-	-	Toro / Ferris Snapper	18,35
PB1108444	Cuchilla mulching Ref. Orig.1057779	457	15,9	-	-	Toro	38,25
PB1108464	Cuchilla Ref. Orig.112884103	500	9,5	-	63,5	Toro	39,75
PB1108465	Cuchilla Ref. Orig.108095403	530	9,5	-	63,5	Toro	22,75
PB1108466	Cuchilla Ref. Orig.131968303	550	9,5	-	63,5	Toro	23,75



## CUCHILLAS TRACTORES ADAPTABLES: PARTNER - HUSQVARNA - JONSERED - MCCULLOCH

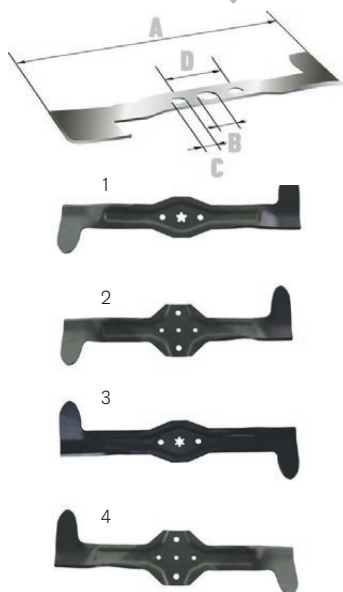

REFERENCIA	DESCRIPCIÓN	A	B	C	D	P.V.P SIN I.V.A.
PB1100017	1.- Cuchilla SX - 532186385	465	5E	13	85	23,95
PB1108197	2.- Cuchilla SX - 532186387	465	9,5	13	-	23,95
PB1108196	3.- Cuchilla DX - 532186386	465	5E	13	85	23,95
PB1108198	4.- Cuchilla DX - 532186388	465	9,5	13	85	23,95
PB1100017	1.- Cuchilla SX - 532180883	542	5E	13	85	19,95
PB1105037	2.- Cuchilla SX - 532446993	542	9,5	13	87	19,95
PB1100018	3.- Cuchilla DX - 532180584	542	6E	13	85	19,95
PB1105033	4.- Cuchilla DX - 532180425	542	9,5	13	87	20,95

## CUCHILLAS TRACTORES CASTELGARDEN / HONDA / VIKING / STIGA



		A	B	C	D	
PB405876	5.- Cuchilla DX 615x55x18,5 mm 82004342/0	620	18,5	8,8	65	17,75
PB405877	6.- Cuchilla SX • 82004343/0	620	18,5	8,8	65	17,75
PB406274	5.- Cuchilla SX • 82004340/1	520	18,5	8,8	65	17,75
PB406275	6.- Cuchilla DX • 82004341/1	520	18,5	8,8	65	17,75
182004360/0	Cuchilla SX - 420mm (mulching)	420	18	8,5	58	28,95
182004361/0	Cuchilla DX - 420mm (mulching)	420	18	8,5	58	28,95
182004358/0	Cuchilla SX - 420 mm	420	18	8,5	55	17,75
182004359/0	Cuchilla DX - 420 mm	417	18	8,5	55	17,75
182004353/0	Cuchilla SX - 462 mm	462	18	8,5	55	19,75
182004354/0	Cuchilla DX - 462 mm	462	18	8,5	55	19,75

## CUCHILLAS CORTACÉSPEDES Y TRACTORES MURRAY / SIMPLICITY / SNAPPER

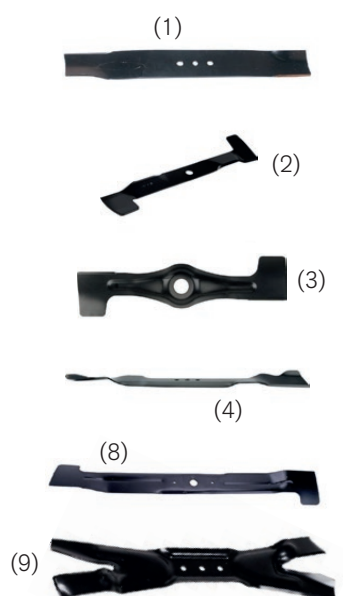

REFERENCIA	DESCRIPCIÓN	A	B	C	D	MODELOS	P.V.P SIN I.V.A.
SY042785E701MA	1. Cuchilla 20"	500	10	10	63	EMP2045	-
SY881076BZYP	2. Cuchilla 16"	410	10	10	47	MP450/MX450/ERDS16550	-
SY880638BZYP	2. Cuchilla 19"	480	10	10	57	MP500/MX550 MXMU19675/ERDS19675	-
SY701195BMYP	3. Cuchilla 19"	480	32	-	-	MXUA19675	-
SY701332YP	3. Cuchilla 21"	530	32	-	-	MXUA21675	-
SY7100851AYP	4. Cuchilla 22"	530	10	10	47	EMP22675HW	-
SY1001427E701MA	Cuchilla 38"	500	21	-	-	LT60	-
SY1002068E701MA	8.- Cuchilla 30"	760	21	-	-	LT60RD	-
SY7026407AYP	9.- Cuchilla 21" Ninja	530	10	10	70	ESPV21675SW	-

## CUCHILLAS CORTACÉSPEDES Y TRACTORES SIMPLICITY / SNAPPER

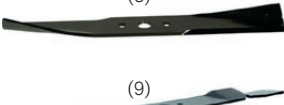
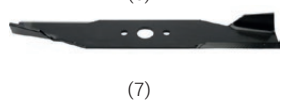
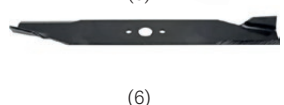
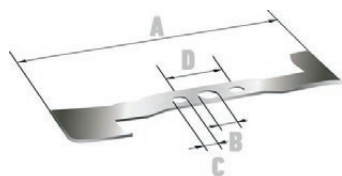

\*(RH: derecha / LH: izquierda)

REFERENCIA	DESCRIPCIÓN	A	B	C	D	MODELOS	P.V.P. SIN I.V.A.
SY7019523BZYP	1.- Cuchilla 33"	83	27	14	19	CORONET RD	
SY885716BMYP	3.- Cuchilla SX/LH	540	20	-	-	ELT2242RDF	
SY885715BMYP	3.- Cuchilla DX/RH	540	20	-	-	ELT2242RDF	
SY885419BZYP	4.- Cuchilla SX/LH	500	20	-	-	ELT17538RDF	
SY885418BMYP	4.- Cuchilla DX/RH	500	20	-	-	ELT17538RDF	
SY1736043AYP	5.- Cuchilla	520	25	10	65	LEGACY	
SY1725922	6.- Cuchilla	410	25	10	65	LEGACY	
SY1726453YP	7.- Cuchilla	460	19	10	65	CONSUMER Z	
SY1716696ASM	8.- Cuchilla 44"	410	19	10	65	REGENT	
SY1719623ASM	9.- Cuchilla DX Mulching	520	25	10	65	REGENT / BARON XL	
SY1719624ASM	9.- Cuchilla SX Mulching	520	25	10	65	REGENT / BARON XL	
PB1108871	10.- Cuchilla 46" salida lateral Ref. Orig.: 1737228BZYP	410	20	-	-	TORO / REGENT SZT150	21,50
PB1108644	11.- Cuchilla 16" Ref. Orig.: 5020843ASM	413	16	-	-	TORO / FERRIS	19,95
PB1103363	12.- Cuchilla 18" Ref. Orig.: 5021227ASM	457	16	-	-	TORO / FERRIS	18,95

## CUCHILLAS ADAPTABLES WEIBANG

REFERENCIA	DESCRIPCIÓN	A	B	C	D	MODELOS	P.V.P. SIN I.V.A.
PB1104245	Cuchilla 4320403010	430	31,9	-	-	WB436/WB435	21,75
PB1104246	Cuchilla 4510403010	445	31,9	-	-	WB435/WB436	21,95
PB1104249	Cuchilla 5020405010	490	31,9	-	-	WB506/WB537	22,95



**CHAVETAS ADAPTABLES A MOTORES BRIGGS STRATTON - TECUMSEH - PUBERT - MARAZZINI**

	REFERENCIA	DESCRIPCIÓN	MEDIDA	MODELOS	P.V.P. SIN I.V.A.
 (1)	<b>PB453167</b>	1. Chaveta volante magnético	15x5x3,5	Briggs & Stratton 61760 / 222698S	0,79
	<b>PB453767</b>	2. Chaveta volante magnético		Tecumseh · Aspera 611004 / 29410012 BU / BVL / BVS	0,95
	<b>PB455817</b>	3. Chaveta volante magnético		Tecumseh · Aspera 610951	0,95
 (2)	<b>PB7106350</b>	6. Chaveta. Ref. Orig. 399680	11,5	Toro	1,12
	<b>MA037305</b>	6. Chaveta eje rueda	3x5x14	SP46/GT45/MX52 GT56/GX51	3,96
	<b>MA037406</b>	4. Chaveta soporte cuchilla	4x6,5x16	SP41/SP46/GT45 MX52/GX51/GT56	1,95
 (3)	<b>MA037506</b>	4. Chaveta	4,75x6,5x15,5	Eje 22,2	1,96
	<b>MA037540</b>	5. Chaveta	4,76x5x40	Eje 25	4,85
	<b>C45-ZJB024</b>	4. Chaveta cigüeñal	3x3,5x10	C41/C45/C50/C62	1,80
 (5)	<b>C26-019</b>	4. Chaveta cigüeñal	3x3,7x10	C26 Camon	1,70
	<b>Ai420210</b>	7. Chaveta eje ahoyador	5x5x14	NEA 39/52 Blue Bird	1,20
	<b>Ai420030</b>	4. Chaveta	10x3,7x3		1,25
 (4)	<b>Ai420060</b>	4. Chaveta disco	10x3,7x2	R29/R41/R54 Blue Bird	0,95
	<b>PU0301040022</b>	5. Chaveta	5x5x18	Pubert	0,69
	<b>PU0301040003</b>	5. Chaveta	5x5x30	Pubert	0,79
 (6)	<b>PU0301040004</b>	5. Chaveta	5x5x40	Pubert	0,69
	<b>PU0301040005</b>	5. Chaveta	5x5x70	Pubert	0,99
	<b>SH2310000056</b>	4. Chaveta	3x5x13	Camon	0,96
 (7)	<b>A26809000102</b>	Chaveta	5x21,5		1,89
	<b>SY1735831</b>	5. Chaveta	9x6x63	Simplicity	1,90
	<b>P538000065</b>	4. Chaveta	12x4,5x3	Husquvarna Maruyama Jonsered	1,91
 (8)	<b>12.014.002.0071</b>	4. Chaveta	4,78x14	QGZ80-30	0,89





REFERENCIA	DESCRIPCIÓN	ALTO / EJE	MODELOS	P.V.P SIN I.V.A.
MA053273	1. Soporte cuchilla	Alto: 52 mm Eje: 22,2 mm	MA.RI.NA / EFCO	19,90
MA053274B22	2. Soporte cuchilla + polea 55mm	Alto: 79 mm Eje: 22,2 mm	SP41T/SP46SH/GT45/MX52	31,90
MA053274B25	2. Soporte cuchilla + polea 55mm	Alto: 79 mm Eje: 25 mm	MTD/ Sterwins Marazzini / ma.ri.na	31,90
00340020120	3. Soporte cuchilla		ASSO67 / PICCOLO	21,85
MA050272	5. Soporte cuchilla	22,2	GT56 / GX51	46,90
PB6109707	7. Soporte+polea 10120200	Alto: 5,5 cm Eje: 22,2 cm	Marazzini • Partner Husquvarna • MEP	7,95
PB6102148	8. Soporte+polea 10831300	Alto: 8,5 cm Eje: 22,2 cm	Marazzini • Partner Husquvarna • MEP	19,55
PB454166	9. Soporte+polea 22465608/0	Eje: 25 mm Alto: 65 mm	Castelgarden / Stiga	7,95
PB454167	9. Soporte+polea 22465607/0	Eje: 22 mm Alto: 68 mm	Castelgarden / Stiga	8,25
PB456777	11. Soporte cuchilla (alto 7cm)	513971800	Husquvarna / Partner: 431/461/471/491	22,95
PB456778	11. Soporte cuchilla (alto 8,5cm)	513971900	Partner: 431/461/471/491	22,95
PB456796	13. Soporte cuchilla 531020654/515131064	Eje: 22 mm Alto: 35 mm	Partner: 146/148/153 Husquvarna	18,50
PB453904	14. Soporte cuchilla Ref. 25463200/0	Eje: 20 mm Alto: 36 mm	Castelgarden	5,75
PB456776	15. Soporte cuchilla	Eje: 22 mm Alto: 75 mm	Green / Lazer / Marazzini	29,75
PB6100349	16. Soporte cuchilla	19,5 mm	MTD	10,95
SY880567YP	26. Soporte cuchilla +Polea	22,2mm	Murray: MX450/MX550	-
SY704793	26. Soporte cuchilla +Polea	25mm	Murray: EQ700	-
PB6109720	19. Soporte cuchilla+eje CPL tractor	Eje: 72,5 mm Polea: 54 mm	Toro 106 - 3987	24,75
SY094129MA	21. Eje cuchilla tractor	Alto: 178 mm Eje: 15,87 mm	Murray: LT60RD	-
PB454001	22. Soporte cuchilla tractor	532128774 Alto: 140mm	Partner • Husquvarna Jonsered • McCulloch	21,45
PB454003	23. Eje cuchillas 5 estrías tractor	532137646 Alto: 178 mm	Partner • Husquvarna Jonsered • McCulloch	24,90
PB454174	23. Eje cuchillas 6 estrías tractor	532165482 Alto: 180 mm	Partner • Husquvarna Jonsered • McCulloch	27,45
PB454004	24. Soporte + eje cuchillas CPL 5 estrías. 532130794	Alto: 180 mm Corte 36" 42"	Partner • Husquvarna Jonsered • McCulloch	39,75
PB454173	24. Soporte + eje cuchillas CPL 6 estrías. 532165579	Alto: 180 mm Corte 36" 42"	Partner • Husquvarna Jonsered • McCulloch	46,75

**CORREAS CORTACÉSPED ADAPTABLES CAMON - MA.RI.NA - HUSQVARNA - MARAZZINI - PARTNER**



REFERENCIA	DESCRIPCIÓN	MEDIDAS	MODELOS	P.V.P SIN I.V.A.
PB00Z295	Correa Z29 1/2	10/6x788 mm	GT45/GT45SH/GX51/ MX52	6,95
PB00Z275	Correa Z27 1/2	10/6x738 mm	SP46S/SP46SH/GT47	6,95
PB000Z16	Correa Z16	10/6x453 mm	GT56SB/GT56SH	5,95
PB000Z25	Correa Z25	10/6x668 mm	GT56SB/GT56SH	5,95
MA10301500	Correa cuchillas SPA1180 LW	13/10x1198 mm	Piccolo	15,95
MA10330130	Correa tracción SPA 85D	13/10x868 mm	Piccolo	12,95
PB000Z34	Correa Z34	10/6x903 mm	Carretilla	7,95
PB10425	Correa Z16	10x425 mm	Dentada	9,72
PB000Z36	Correa Z36	10/6x953 mm	As Motor / Tromeca	7,75
PB000Z30	Correa Z30	10/6x803 mm	CastelGarden Honda / Stiga	6,95
PB000Z33	Correa Z33	10/6x878 mm	CastelGarden / Iseki	7,95
PB000Z34	Correa Z34	10/6x903 mm	Iseki / Stiga	21,84
PB000Z36	Correa Z36	10/6x953 mm	As Motor / Tromeca	7,95
PB000Z14	Correa Z14	10/6x398 mm		5,95
PB000Z195	Correa Z19 1/2	10/6x540 mm		6,95
PB000Z305	Correa Z20 1/2	10/6x813 mm	Stiga	6,95
PB10530	Correa Z21	10/6x568 mm	Stiga	6,95
PB000Z24	Correa Z24	10/6x648 mm	Al-Ko / Stiga	5,95
PB000Z25	Correa Z25	10/6x668 mm	CastelGarden / Honda	6,95
PB000Z30	Correa Z30	10/6x803 mm	CastelGarden / Honda	6,95
PB000Z315	Correa Z31 1/2	10/6x838 mm		6,95
PB000Z33	Correa Z33	10/6x878 mm	CastelGarden / Iseki	7,25
PB000Z355	Correa Z33 1/2	10/6x888 mm	Honda	7,25
PB420080	Correa Z35	10/6x928 mm	Honda	7,25
2102600016N	Correa	Z813	DYM1560 / DYM1588	10,90
2102600018N	Correa	Z762	DYM1720	10,90
2102600036N	Correa	Z750	DYM1626	10,90
2102600050A	Correa acanalada	PJ475	DYM1115	10,95
2102600058A	Correa acanalada	EPJ470	DYM1180	12,95
2202600011F	Correa dentada	261-3M	DYM2129A	8,95
P506347403	Correa cortadora EM Husqvarna / Partner	Dentada	Partner: K950 12" / 14"	9,95
P506347407	Correa cortadora EM Husqvarna / Partner	Dentada	Partner: K1250 12"/14"/16"	10,95
P506347438	Correa cortadora EM Husqvarna / Partner	Dentada	Partner: K1250 RAIL 16"	14,95



**CORREAS TRACTORES CORTACÉSPEDES ADAPTABLES: CASTELGARDEN - PARTNER - HUSQVARNA - JONSERED - MCCULLOCH**

	REFERENCIA	DESCRIPCIÓN	Nº DIENTES	REF. ORIGINAL	MODELOS	P.V.P SIN I.V.A.
	PB420685	1. Correa cuchillas dentada	200	200DS8M1600	Honda / Castelgarden: Husqvarna / Viking	33,75
	PB420686	1. Correa cuchillas dentada	225	250DS8M1800	Castelgarden / Honda Viking / Husqvarna	46,95
	PB990024	1. Correa cuchillas dentada	220	200DS8M1760	Toro/Regent RD/Murray	39,90
	PB998830	1. Correa cuchillas dentada	250	200DS8M2000	Murray / Toro	66,95
	PB998831	1. Correa cuchillas dentada	325	200DS8M2600	John Deere	76,75
	PB998832	1. Correa cuchillas dentada	220	250DS8M1760	Murray / sNAPPER	68,95
	PB011436	Correa cuchillas AA85		35065700/0	Castelgarden:J92/JP92 JT92 y hydro	17,50
	PB420902	Correa cuchillas corte 36"		532131264	MTD / Husqvarna	29,95
	PB420907	Correa cuchillas corte 42"		532144200	Husqvarna	20,95
	PB420398	Correa cuchillas corte 42"		532402009 584897001	AA112	24,75
	PB420397	Correa cuchillas corte 36"		532402008	AA105	20,79
	PB420372	Correa tracción corte 36"		532165632	John Deere / Husqvarna	25,90
	PB420981	Correa cuchillas corte AA73		690071 1001223	Murray	15,95
	PB013403	Correa tracción corte 42"/107cm		532170140 583036701	Toro / Husqvarna	29,75
						

**CORREAS CORTACÉSPEDES Y TRACTORES MURRAY - SIMPLICITY - SNAPPER**

	SY880424YP	Correa Murray			MX450 / ERDS16550	-
	SY880268YP	Correa Murray			MX550 / ERDS19675 MXH550 / MXMU675	-
	SY7101193MA	Correa Murray			EMP22675HW	-
	SY7701014MA	Correa Murray			POWER TRIM (desbrozadora nylon)	-
	SY710231MA	Correa Tracción Murray			Modelos antiguos	-
	SY1001223MA	Correa Cuchillas Murray			Modelos antiguos	-
	SY037X86MA	Correa Cuchillas Murray			LT60	-
	SY037X87MA	Correa Tracción Murray			LT60 / LT60RD	-
	SY037X74MA	Correa cuchillas Murray			LT60RD	-
	SY885483YP	Correa Cuchillas		Corte: 96 cm	ELT17538RDF	-
	SY885714YP	Correa Cuchillas		Corte: 107 cm	ELT2242RDF	-
	SY7100883YP	Correa Simplicity			EYPV21675SW	-
	SY1721532SM	Correa Simplicity			REGENT Mulching	-
	SY1728008SM	Correa Tracción (Salida lateral 46")			REGENT	-
	SY1732956SM	Correa cuchillas (Salida lateral 46")			REGENT	-
	SY885018YP	Correa cuchillas		Corte 33"	CORONET RD	-
	SY885015YP	Correa Tracción		Corte 33"	CORONET RD	-
	SY1735832	(A) Correa cuchillas dentada			REGENT RD	-
	SY1735986	Correa cuchillas lisa		17x1200	REGENT RD	-
	SY1752054	Correa Tracción		13x2580	REGENT RD	-

## CORREAS TRACTORES CORTACÉSPED SIMPLICITY - MURRAY - SNAPPER



REFERENCIA	DESCRIPCIÓN	CORTE	MODEL N°	MODELOS	P.V.P SIN I.V.A.
<b>SY1737441YP</b>	Correa tracción	42"/107cm	2691218	SLT100	-
<b>SY1732955SM</b>	Correa cuchilas	42"/107cm	2691218	SLT100	-
<b>SY1728008SM</b>	Correa tracción	46"/118cm	2691262	SLT200	-
<b>SY1732956SM</b>	Correa cuchilas	46"/118cm	2691262	SLT200	-
<b>SY885895YP</b>	Correa 1ª cigüeñal	38"/96cm	2691263	SRD100	-
	Correa 1ª cigüeñal	42"/107cm	2691265	SRD300	-
<b>SY885495YP</b>	Correa 2ª tracción	38"/96cm	2691263	SRD100	-
	Correa 2ª tracción	42"/107cm	2691265	SRD300	-
<b>SY1758762YP</b>	Correa cuchilas	46"/118cm	2691263	SRD100	-
<b>SY1758760YP</b>	Correa cuchilas	46"/118cm	2691263	SRD300	-

## POLEAS TRACTORES CORTACÉSPED Y MOTOAZADAS

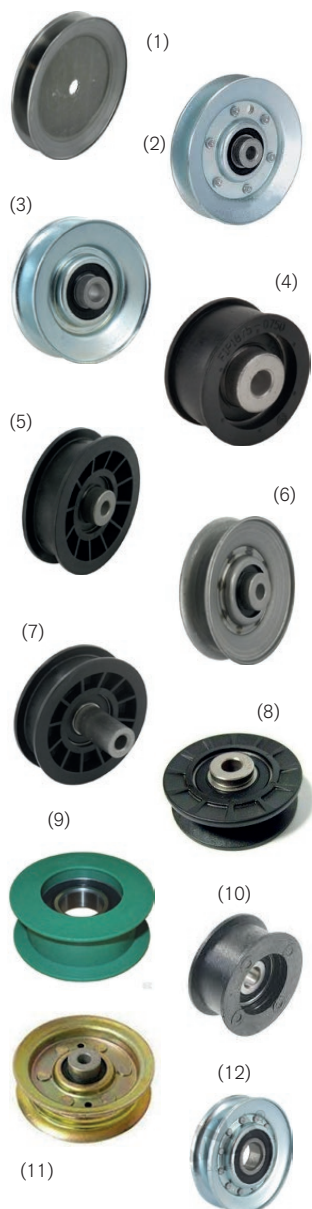

REFERENCIA	DESCRIPCIÓN	INT. (MM)	EXT. (MM)	ALTURA (MM)	P.V.P SIN I.V.A.
<b>PB6207011</b>	1. Polea eje cuchillas Husqvarna · Jonsered · Partner · McCulloch	15,8	139,7	23,4	27,75
<b>PB6282926</b>	1. Polea eje cuchillas Husqvarna · Jonsered · Partner · McCulloch	15,8	127	25	9,75
<b>PB430138</b>	2. Polea tensora corte 532146763 Husqvarna · Jonsered · Partner · McCulloch	9,05	108	24	19,75
<b>PB015678</b>	3. Polea guía tracción 532199534 Husqvarna · Jonsered · Partner · McCulloch	7,9	63,5	12,7	13,75
<b>PB430067</b>	4. Polea tensor tracción 532165630 Husqvarna · Jonsered · Partner · McCulloch	9,5	51	25	12,90
<b>PB430038</b>	5. Polea tensora 532165936 Husqvarna · Jonsered · Partner · McCulloch	9,5	89	25,4	16,75
<b>PB6201250</b>	6. Polea tensora Husqvarna · Jonsered · Partner · McCulloch	9,5	90,5	28,6	22,75
<b>PB430017</b>	7. Polea tensora 532179114 Husqvarna · Jonsered · Partner · McCulloch	9,5	89	54	13,75
<b>PB430014</b>	8. Polea tracción 532165626 Husqvarna · Jonsered · Partner · McCulloch	9,5	63,5	10	13,95
<b>PB456185</b>	9. Polea tensora Castelgarden / Viking / Stiga 25601558/2	15	50	20	7,35
<b>PU0341000003</b>	10. Rodillo tensor Pubert Motoazadas	10	51,5	24	13,90
<b>PB454268</b>	11. Polea tensora 532173438	9,5	98,5	28	14,75
<b>PB6207168</b>	12. Polea guía Murray / Toro / Oleo Mac	17	75	17	17,75

**SACOS TELA Y SOPORTE METÁLICO CORTACÉSPED CAMON - MA.RI.NA - MURRAY - SIMPLICITY - SNAPPER - STERWINS**

REFERENCIA	DESCRIPCIÓN	MODELOS	P.V.P SIN I.V.A.
MA047083	Saco tela	SP41 / SP46 / GT45 / GT47	49,95
MA051083.05	Saco tela	GX51SB	53,75
MA053083	Saco tela	MX52SB/MX52SH	59,95
MA050083	Saco tela	GT56SB/GT56SH	59,95
G22150A1000	Saco tela	G46SHL / G51SHL	29,88
AI20050080009	Saco tela	B51T / H51T	46,95
SY7102573YP	Saco tela	Murray EMP22675HW	-
AI2007010000	Saco tela	B46T	39,75
MA051078	SopORTE metálico	GX51SB	53,75
MA050078	SopORTE metálico	GT56SB / GT56SH	45,35
G2641200000	SopORTE metálico	G42P / ZE42-E40	12,78
G4661200000	SopORTE metálico	G46SHL / G51SHL / ZE46	22,67
GLE30000010	SopORTE metálico	ZA-380	16,79

**CONDENSADORES**

PB000017	Condensador 10 $\mu$ F	M8/35mm	5,75
PB000018	Condensador 12 $\mu$ F	M8/35mm	5,90
PB000019	Condensador 16 $\mu$ F	M8/40mm	8,45
PB000020	Condensador 18 $\mu$ F	M8/40mm	8,90
PB000021	Condensador 20 $\mu$ F	M8/45mm	7,95
PB000022	Condensador 25 $\mu$ F	M8/40mm	7,95
PB000023	Condensador 30 $\mu$ F	M8/40mm	8,35
PB000024	Condensador 35 $\mu$ F	M8/45mm	9,95
PB000025	Condensador 40 $\mu$ F	M8/45mm	10,25
PB000026	Condensador 50 $\mu$ F	M8/50mm	10,95
PB000027	Condensador 60 $\mu$ F	M8/50mm	13,95

**POLEAS MOTOR**

(1) (2)

PU0306060004	1. Polea motor D50 Ø 19,05mm	Pubert: Briggs Stratton GT600 7 CG170	18,31
PU0306060005	1. Polea motor D55 Ø 19,05mm	Pubert: GC135/160 GX120/160	16,15
MA050262	2. Polea motor D55 Ø 22,2mm	Marina / Sterwins	21,95

**POLEAS TRACCIÓN**

(1) (2)



(3)

MA050240	1. Polea 55x12mm	Marina / Sterwins Catelgarden / Husqvarna	17,95
MA050241	1. Polea 60x12mm	Marina / Sterwins Catelgarden / Husqvarna	17,95
2102100012B	2. Polea	DYM1626CQ	14,95
PB6207060	3. Polea 80 mm	Honda/MTD/GGP/Pubert	14,29



**CABLES CORTACÉSPED CAMON Nº SERIE POSTERIOR A 0408500 MA.RI.NA / STERWINS**



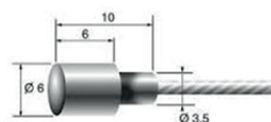
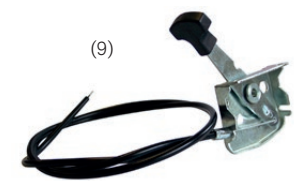
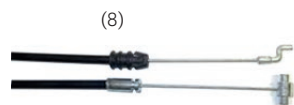

REFERENCIA	DESCRIPCIÓN	MODELOS	P.V.P SIN I.V.A.
MA046148	8. Cable freno L=1035	SP41T / SP41B / MX52SB / GT45SB	16,95
MA046149	8. Cable freno L=1070	SP46ST / GT56SB	21,95
MA052149	8. Cable freno L=1245	SP46SH / GT45SH / MX52SH	28,75
MA052146	8. Cable freno L=1120	SP46SH / GT56SB / QUANTUM60	25,75
MA053142	9. Mando + Cable Gas L=1085	SP41T / GT45SH / MX52SH	19,75
MA047143	9. Mando + Cable Gas L=1160	SP41B / SP46ST / MX52SB	25,75
MA047142	9. Mando + Cable Gas L=1025	SP46SH	18,95
MA050143	9. Mando + Cable Gas L=1220	GT45SB / GT56SB	26,95
MA056143	9. Mando + Cable Gas L=1300	GT56SH	28,75
MA052138	10. Cable tracción	SP46ST / SP46SH / GT45 MX52 / GT56SB / GT56SH	31,92
MA056153	11. Cable Variador	GT56SB / GT56SH	26,95

**CABLES CORTACÉSPEDES Y TERMINALES ADAPTABLES**

PB453593	Cable 225cm	Ø 1,2mm	3,29
PB454383	Cable 250cm	Ø 1,8mm	3,95
PB453581	Cable 250cm	Ø 2mm	3,75
PB453583	Cable 250cm	Ø 2,5mm	4,25
PB454393	Cable 250cm	Ø 2mm	9,25
PB454391	Cable 250cm	Ø 1,5mm	5,95



**CABLES CORTACÉSPED Y TERMINALES ADAPTABLES**

	REFERENCIA	DESCRIPCIÓN	MODELOS	P.V.P SIN I.V.A.
 (1)	<b>G020</b>	1. Mando + cable velocidad	Universal	7,50
 (2)	<b>PB000225</b>	2. Terminal Cable Z		1,69
 (3)	<b>PB453589</b>	3. Tornillo ajuste + tuerca 5,6mm		2,75
 (4)	<b>PB453590</b>	4. Tornillo ajuste + tuerca 6,2mm		3,15
 (5)	<b>PB000578</b>	5. Boquilla de vaina plástica		1,89
 (6)	<b>PB454562</b>	6. Tope cable Ø 3,5mm		1,95
 (7)	<b>PB453654</b>	7. Racor roscado 3,5mm, cilíndrico 9x25mm		2,75
 (8)	<b>PB000227</b>	8. Tope cable 6,5mm para cable máx. Ø 2,5 mm		1,79
 (9)	<b>PB453676</b>	9. Pomo + tornillo 8x50 cortacéspedes		3,95

**FUNDAS Y CABLES**

	<b>PB453571</b>	Funda Cable 25 metros	2,3 x 4,9mm	51,95
	<b>PB453570</b>	Funda Cable 25 metros	2,5 x 4,9mm	53,95
	<b>PB453572</b>	Funda Cable 25 metros	3,5 x 5,7mm	59,95
	<b>PB91040070</b>	Funda Cable 25 metros	4,0 x 7,2mm	119,95
	<b>PB06071</b>	Boquilla funda 7x11 mm	Ø 2mm	0,79
	<b>PB453681</b>	Boquilla funda 7x11 mm	Ø 3,5mm	0,90
	<b>PB453591</b>	Boquilla funda 14x8mm	Ø 3,5mm	1,89
	<b>PB800150</b>	Cable 25 metros	Ø 5,9mm	16,95
	<b>PB800250</b>	Cable 25 metros	Ø 2,5mm	23,95
	<b>PB454384</b>	Cable 220cm	Ø 1,2mm	3,45
	<b>PB454383</b>	Cable 250cm	Ø 1,8mm	3,95
	<b>PB003215</b>	Cable + enchufe 3 metros	2 x 1,5mm	7,95
	<b>PB005215</b>	Cable + enchufe 5 metros	2 x 1,5mm	16,25

## ENGRANAJES RUEDAS CORTACÉSPEDES ADAPTABLES



REFERENCIA	DESCRIPCIÓN	MODELOS	P.V.P SIN I.V.A.
MA050298	Engranaje DX / SX	MA.RI.NA Lazer	9,95
PB1225701101	Engranaje DX 10T	Castelgarden / Stiga	9,75
PB1225701310	Engranaje SX 13T	Castelgarden / Stiga	16,75
PB1225701330	Engranaje DX 12T	Castelgarden / Stiga	10,65
PB1225701340	Engranaje SX 12T	Castelgarden / Stiga	10,65
PB6409004	Engranaje	MTD/TORO 112-0863	14,25
PB6206349	Engranaje	TORO 39-9160	7,79
PB6206348	Engranaje	TORO 18-9690	8,79
G54AL000000	Engranaje SX	G46SHL/G51SHL/G51SHLGCV170	9,89
G54AM000000	Engranaje DX	G46SHL/G51SHL/G51SHLGCV170	9,89

## RUEDAS UNIVERSALES ADAPTABLES



PB453715	1. Rueda 150 mm + Casquillos	Interior: 8-10-12 mm	11,75
PB453719	1. Rueda 180 mm + Casquillos	Interior: 8-10-12 mm	15,90
PB453720	1. Rueda 200 mm + Casquillos	Interior: 8-10-12 mm	16,90
PB455773	2. Rueda 180X38 mm eje 12,2 mm con rodamientos	Castelgarden / Stiga	14,95
PB455774	2. Rueda 200X38 mm eje 12,2 mm con rodamientos	Castelgarden	17,95
PB455776	2. Rueda 200X38 mm eje 12,7 mm con rodamientos	Honda	18,95
PB453398	3. Neumático Honda 220x57	Honda 42861VB5801	9,75
PB455202	4. Rueda remolque eje 16 mm	480 / 400-8	27,95
PB455317	4. Rueda remolque eje 20 mm	600-6	35,95
PB60075	5. Rueda pivotante con freno eje 75x22mm	Máx: 50kg	7,95
PB600100	5. Rueda pivotante con freno eje 100x30mm	Máx: 70kg	12,75

**RUEDAS CORTACÉSPED CAMON - MA.RI.NA. - STERWINS**

(11)



(12)



(13)

REFERENCIA	DESCRIPCIÓN	Ø EXT.	Ø INT.	MODELOS	P.V.P SIN I.V.A.
<b>MA033108</b>	Rueda delantera DX/SX	125	12	SP33E / SP40E	10,75
<b>MA033109</b>	Rueda trasera DX/SX	150	12	SP33E / SP40E	11,95
<b>MA047109</b>	Rueda con casquillo	180	7	SP33E / SP40E	21,85
<b>MA050112</b>	Rueda trasera DX/SX c/rodamiento	200	12	GT47E	33,75
<b>MA042106</b>	Rueda delantera DX/SX c/rodamiento	150	12	SP41T / SP41B / GX51SB	21,85
<b>MA050106</b>	Rueda delantera DX/SX c/rodamiento	180	12	SP46ST / SP46SH GX51SB / GT47E SP41T / SP41B	28,75
<b>MA050118</b>	11. Rueda trasera DX/SX c/rodamiento	200	12	SP46ST / SP46SH GT45 / GT47	46,95
<b>MA056118</b>	13. Rueda trasera DX/SX c/rodamiento	230	12	GX51SB	53,76
<b>MA053118.98</b>	13. Rueda delantera	206	12	MX57	49,90

## RUEDAS CORTACÉSPED CAMON - MA.RI.NA. - STERWINS



DX=derecha / SX=izquierda



REFERENCIA	DESCRIPCIÓN	Ø EXT.	Ø INT.	MODELOS	P.V.P SIN I.V.A.
MA047118.98	Rueda delantera DX/SX c/rodamiento	180	12	MX52SB / MX52SH	39,75
MA053128.98	Rueda trasera DX/SX c/rodamiento	210	12	MX52SB / MX52SH	51,95
MA056113	Rueda Alum. delantera DX/SX	180	12	GT56SB / GT56SH	31,90
AI2088035200	Rueda delantera			B42	13,95
AI2088036200	Rueda trasera			B42	10,96
AI2088030000	Rueda delantera			B46T/B51T/H51T	16,75
AI2088031000	Rueda trasera			B46T/B51T/H51T	19,75

## CUBIERTAS PERFIL T510



REFERENCIA	TAMAÑO	PRESIÓN MÁXIMA	P.V.P SIN I.V.A.
PB350X6	3.50-6	2,5 Bar	21,75
PB350X8	3.50-8	2,5 Bar	19,85
PB400X6	4,00-6	2,5 Bar	18,75
PB400X8	4.00-8	2,5 Bar	19,75

## CUBIERTAS PERFIL T463



REFERENCIA	TAMAÑO	CARGA MÁXIMA	P.V.P SIN I.V.A.
PB35064	3.50-6	165 kg	29,75
SL120	4.80 / 4.00-8	155 kg	34,75
PB1350064	13X500-6	200 kg	36,75
PB1665084	16X650-8	280 kg	59,75
PB231050128	23X10.50-12	8 Lonas	202,75

**CUBIERTAS TRACTORES ADAPTABLES (tiene que montarse cámara)**

	REFERENCIA	MEDIDAS	PERFIL	P.V.P SIN I.V.A.
	PB453725	(1). 11x400x4	HF-224	33,75
	PB453726	(1). 11x400x5	HF-224	29,75
	PB453727	(2). 13x500x6	T-539	31,95
	PB454103	(2). 13x650x6	HF-224	49,75
	PB453731	(2). 15x600x6	HF-224	38,75
	PB453196	(3). 16x650x8	T-639	49,95
	PB454106	(3). 18x650x8	HF-224	49,95
	PB454107	(3). 18x8,50x8	S-366	69,75
	PB454108	(4). 18x9,50x8	HF-224	69,95
	PB456078	(4). 20x800x8	HF-224	89,75
	PB454102	(4). 20x800x10	HF-224	139,00
	PB201008	(4). 20x10-8	K-500	139,00
	SY1725724	26x12-12	Snapper / Simplicity / Murray	269,00

**CÁMARAS TRACTORES ADAPTABLES**

	REFERENCIA	MEDIDAS	VÁLVULA	P.V.P SIN I.V.A.
	PB3504104	4.10/3.50-4	Stiga / Castelgarden TR87	7,95
	PB504006	350/400x6	TR13	9,95
	SL122	500x10	TR13	11,95
	PB453796	11x400x5	TR13	10,95
	PB3504008	3,50/4,00x8	TR13	5,75
	PB453784	13x500x6	TR13	8,90
	PB453785	15x600x6	TR13	9,90
	PB453141	16x650x8	TR13	9,95
	PB186508	18x650x8	TR13	21,75
	PB453716	18x850/950x8	TR13	16,75
	PB454101	20x800/1000x10	TR13	19,50

**RUEDAS PUBERT**

REFERENCIA	DESCRIPCIÓN	MEDIDAS	MODELOS	P.V.P. SIN I.V.A.
PU0340030019	Rueda trasera	420	Xplorer	60,35
PU0340030070	Rueda trasera	420	Xplorer 2018	60,35
PU0340030026	Rueda trasera		P51 Xtrem	78,40
PU0309000001	Rueda DX	3.50-6	Junior	127,95
PU0309000002	Rueda SX	3.50-6	Junior	127,95
PU0309000017	Rueda SX	16x6.50-8	Senior	194,15
PU0309000018	Rueda DX	16x6.50-8	Senior	194,15
PU3001000031	Rueda transporte CPL		Pubert	25,30
PU0309000009	Rueda delantera	195x45 mm eje 20 mm	Pubert: P51 CP51/E51	24,15
PU0309000013	Rueda delantera	200x40 mm eje 12 mm	Pubert: P51/CP51 E51/5110/5112	16,45
PU8100021411	Kit ruedas (opcional)	70cm	L Senior	699,75



**TRIMMYS ADAPTABLES**

	REFERENCIA	DESCRIPCIÓN	P.V.P SIN I.V.A.
	<b>G0462</b>	Trimmy Autocut 4.62 Stihl con adaptador M12X125F y M12X150F	16,75
	<b>G0462-12X150F</b>	Adaptador 12X150F - Izquierdo	2,59
	<b>G0462-12X125F</b>	Adaptador 12X125F - Izquierdo	2,59
	<b>G1104-12X175F</b>	Adaptador 12X175F - Izquierdo	2,59
	<b>G0462-1</b>	Tapa inferior Trimmy G0462	6,61
	<b>G0462-2</b>	Botón + carrete Trimmy G0462	6,69
	<b>G0462-3</b>	Ovalillo Trimmy G0462	1,59
	<b>G0462-4</b>	Muelle Trimmy G0462	1,39
	<b>G0462-5</b>	Carcasa superior Trimmy G0462	6,79
	<b>T25</b>	(6) Trimmy presión T25 · 105 mm Con adaptadores: 10x1.25 hembra / 8x1.25 macho	11,95
	<b>T35</b>	(7) Trimmy presión T35 · 115mm Con adaptadores: 10x1.25 / 12x1.75 hembra	13,90
	<b>T45</b>	(8) Trimmy presión T45 · 145mm Con adaptadores: 10x1.25 / 12x1.75 hembra	14,95
	<b>T45-AL</b>	(8A) Trimmy presión T45 (con rodamiento) Botón aluminio M12x1,75H	17,96
	<b>SH2320076129</b>	(9) Trimmy 3GC430 / 3GC520 / M12X1.75	10,90
	<b>SH2320038607</b>	(10) Trimmy CG260 / CG330-E / CG430-E / BG43 / M10X1.25 BG520 / Q33 / Q43	10,90
	<b>0809.000400</b>	(11) Trimmy YT6915/Samurai/Flymo	5,95
	<b>SH2320040052</b>	(12) Trimmy SG250 / 3CS23EF 8x1.25	6,96



## ADAPTADORES T25 / T35 / T45



REFERENCIA	DESCRIPCIÓN	P.V.P SIN I.V.A.
G0015	Adaptador 8x125 / 10x125 Izq. Macho T25 / T35	1,95
G0016	Adaptador 10x125 / 10x125 Izq. Macho T25 / T35 / T45	1,95
G0014	Adaptador 10x125 / 12x175 Izq. Macho T25 / T35 / T45	1,95
G0017	Adaptador 10x125 / 10x150 Izq. Macho T25 / T35 / T45	1,95
G0013	Adaptador 10x150 / 12x175 Izq. Macho	1,95
G0018-T25	Adaptador M8x125 Izq. Hembra T25	2,59
G0018-T35	Adaptador M8x125 Izq. Hembra T35	2,59
G0019-T25	Adaptador M10x100 Izq. Hembra T25	2,59
G0019-T35	Adaptador M10x100 Izq. Hembra T35	2,59
G0020-T35	Adaptador M10x125 Izq. Hembra T35	2,59
G0020-T45	Adaptador M10x125 Izq. Hembra T45	2,59
G0022-T35	Adaptador M10x150 Izq. Hembra T35	2,59
G0023-T35	Adaptador M12x150 Izq. Hembra T35	2,59
G0023-T45	Adaptador M12x150 Izq. Hembra T45	2,59
G0024-T35	Adaptador M12x175 Izq. Hembra T35	2,59
G0024-T45	Adaptador M12x175 Izq. Hembra T45	2,59

## DESPIECE T25 / T35 / T45



2



3



6



5



4



1

REFERENCIA	DESCRIPCIÓN	P.V.P SIN I.V.A.
T25-1	1. Tapa carrete	2,59
T35-1	1. Tapa carrete	2,95
T45-1	1. Tapa carrete	2,75
T25-2	2. Botón	2,75
T35-2	2. Botón	2,95
T45-2	2. Botón	2,95
T25-3	3. Carrete hilo	2,75
T35-3	3. Carrete hilo	2,95
T45-3	3. Carrete hilo	2,95
T25-4	4. Ovalillo T25 / T35 / T45	1,39
T25-5	5. Muelle	1,59
T35-5	5. Muelle T35 / T45	1,59
T25-7	6. Carcasa	3,50
T35-7	6. Carcasa	3,95
T45-7	6. Carcasa	3,95

**OVALILLOS CABEZALES DE HILO**

REFERENCIA	DENOMINACIÓN	P.V.P SIN I.V.A.
<b>AI091350</b>	1. Ovalillo R41 / R54 / R29 / Bluebird	1,69
<b>G11092-3</b>	2. Ovalillo para Trimmy G11092 / Tecomec	1,29
<b>T25-4</b>	3. Ovalillo para Trimmy G1104 / T25 / T35 / T45	1,39
<b>G1125-2</b>	4. Ovalillo para Trimmy G1125 / G1129 / Husquvarna T50	1,39
<b>PB990076</b>	5. Ovalillo Sthil 40027138301	2,15
<b>PB454941</b>	6. Ovalillo	5,55
<b>G1127-2</b>	7. Ovalillo para Trimmy G1127	1,39
<b>2209300019C</b>	8. Ovalillo DYM2129A	0,49
<b>G0462-3</b>	9. Ovalillo G0462/STIHL	1,49

**TRICUT PARA HIERBA**

REFERENCIA	DESCRIPCIÓN	P.V.P SIN I.V.A.
<b>Ai721850</b>	Tricut Ø 32 mm	16,95
<b>Ai751250</b>	Recambio Kit Cuchillas Nylon	3,39

**CABEZALES DE ALUMINIO NYLSAW UNIVERSALES**

<b>Ai752950</b>	Cabezal aluminio "Speed" 2 hilos original	37,95
<b>PB999916</b>	Cabezal aluminio "Speed" 2 hilos adaptable	13,95
<b>Ai752960</b>	Cabezal aluminio "Speed" 4 hilos original	48,95
<b>PB999917</b>	Cabezal aluminio "Speed" 4 hilos adaptable	13,95
<b>PB454907</b>	Kit de 2 trinquetes + 2 muelles (repuesto)	17,95
<b>PB454906</b>	Base cabezal de Aluminio (repuesto)	9,95

**DONUT BOBINA NYLON SIERRA NYLSAW**

<b>AI544740</b>	37 m ø 3 mm	15,90
<b>AI544750</b>	27 m ø 3,5 mm	15,90
<b>AI544760</b>	21 m ø 4 mm	15,90
<b>AI544770</b>	16 m ø 4,5 mm	15,90

## CABEZALES DE NYLON

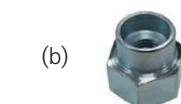
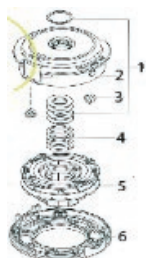
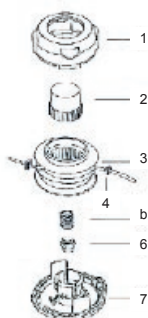

REFERENCIA	DESCRIPCIÓN	P.V.P SIN I.V.A.
<b>G1104</b>	Cabezal de nylon semiautomático con adaptador 10x1.25 F	13,95
<b>G0015</b>	(a). Adaptador 8x1.25 M - Izquierdo	1,95
<b>G1104-8X125F</b>	(b). Adaptador 8x1.25 F - Izquierdo	2,59
<b>G1104-10X100F</b>	(b). Adaptador 10x1.00 F - Izquierdo	2,59
<b>G1104-10X150F</b>	(b). Adaptador 10x1.50 F - Izquierdo	2,59
<b>G1104-12X125F</b>	(b). Adaptador 12x1.25 F - Izquierdo	2,59
<b>G1104-12X175F</b>	(b). Adaptador 12x1.75 F - Izquierdo	2,59
<b>G1104-1</b>	Fig. nº1 Tapa superior	2,90
<b>G1104-2</b>	Fig. nº2 Boton trimy	2,90
<b>G1104-3</b>	Fig. nº3 Carrete	2,90
<b>T25-4</b>	Fig. nº4 Ovalillo	1,39
<b>G1104-5</b>	Fig. nº5 Muelle	1,39
<b>G1104-7</b>	Fig. nº 7 Carcasa inferior	3,25
<b>G11092</b>	Cabezal de nylon semiautomático Universal Carga rápida	14,50
<b>G11092-1</b>	Fig. nº1 Kit arandelas	0,90
<b>G11092-2</b>	Fig. nº2 Carcasa inferior	3,95
<b>G11092-3</b>	Fig. nº3 Ovalillo	1,29
<b>G11092-4</b>	Fig. nº4 Muelle	1,39
<b>G11092-5</b>	Fig. nº5 Carrete + botón	4,45
<b>G11092-6</b>	Fig. nº6 Carcasa superior	3,95
<b>G11091</b>	Cabezal de nylon semiautomático con adaptador 10x1.25 F Carga rápida	14,25
<b>G0015</b>	(a). Adaptador 8x1.25 M - Izquierdo	1,95
<b>G11091-10X100F</b>	(b). Adaptador 10x1.00 F - Izquierdo	2,59
<b>G11091-10X150F</b>	(b). Adaptador 10x1.50 F - Izquierdo	2,59
<b>G11091-12X125F</b>	(b). Adaptador 12x1.25 F - Izquierdo	2,59
<b>G11091-12X175F</b>	(b). Adaptador 12x1.75 F - Izquierdo	2,59
<b>G11091-12X150F</b>	(b). Adaptador M12x1.50F Stihl - Izquierdo	2,59
<b>G11091-14X150F</b>	(b). Adaptador M14x1.50F Stihl - Izquierdo	2,59
<b>G2103</b>	Multifilo universal (1 tornillo inferior)	9,95
<b>AI031850</b>	Tornillo repuesto para G2103	0,41
<b>G2104</b>	Multifilo universal (1 tornillo lateral)	9,95
<b>G2104-1</b>	Tornillo repuesto para G2104	0,89

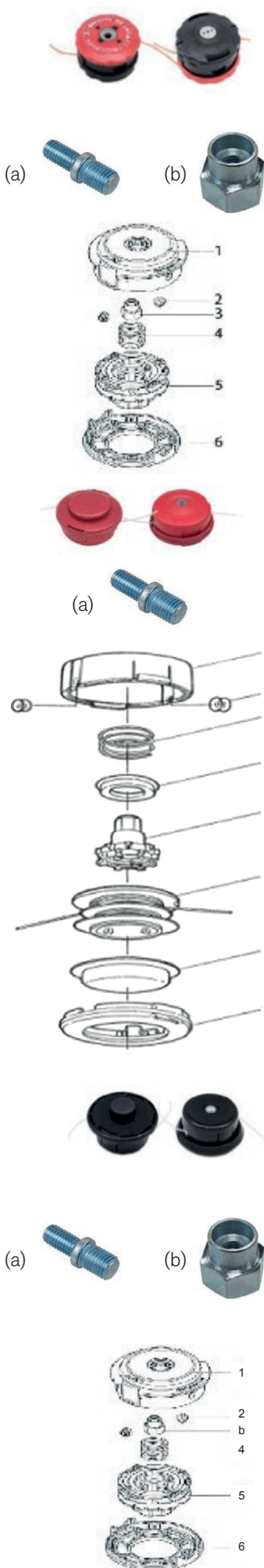
**CABEZALES DE NYLON**

REFERENCIA	DESCRIPCIÓN	P.V.P SIN I.V.A.
<b>G1125</b>	Cabezal de nylon semiautomático con adaptador 10x1.25 F	14,95
<b>G1125-8X125F</b>	(b). Adaptor 8x1.25 F - Izquierdo	2,59
<b>G0015</b>	(a). Adaptor 8x1.25 M - Izquierdo	1,95
<b>G1125-10X100F</b>	(b). Adaptor 10x1.00 left F - Izquierdo	2,59
<b>G1125-10X150F</b>	(a). Adaptor 10x1.50 left F - Izquierdo	2,59
<b>G1125-1</b>	Fig. nº1 Tapa superior	2,90
<b>G1125-2</b>	Fig. nº2 Ovalillo	1,39
<b>G1125-4</b>	Fig. nº 4 Muelle	1,39
<b>G1125-5</b>	Fig. nº5 Carrete	2,90
<b>G1125-6</b>	Fig. nº 6 Carcasa inferior	2,90
<b>G1127</b>	Cabezal de nylon semiautomático con adaptador 10x1.25 F	13,90
<b>G0015</b>	(a). Adaptador 8x1.25 M - Izquierdo	2,59
<b>G1127-10X100F</b>	(8). Adaptador 10x1.00 left F - Izquierdo	2,59
<b>G1127-10X150F</b>	(8). Adaptador 10x1.50 left F - Izquierdo	2,59
<b>G1127-12X125F</b>	(8). Adaptador 12x1.25 left F - Izquierdo	2,59
<b>G1127-12X175F</b>	(8). Adaptador 12x1.75 left F - Izquierdo	2,59
<b>G1127-1</b>	Fig. nº1 Tapa superior	1,31
<b>G1127-2</b>	Fig. nº2 Ovalillo	1,39
<b>G1127-3</b>	Fig. nº3 Arandela	1,10
<b>G1127-4</b>	Fig. nº 4 Muelle	1,29
<b>G1127-5</b>	Fig. nº5 Carrete	4,19
<b>G1127-6</b>	Fig. nº 6 Carcasa inferior	3,95
<b>G1127-7</b>	Fig. nº 7 Botón	3,95
<b>G1129</b>	Cabezal de nylon semiautomático con adaptador 8x1.25 F	11,95
<b>G1129-12X175F</b>	(b) Adaptador 12x17.5 F - Izquierdo	2,59
<b>G0015</b>	(a) Adaptador 10x1.25 M - Izquierdo	2,59
<b>G1129-10X125F</b>	(b) Adaptador 10x1.25 F - Izquierdo	2,59
<b>G1129-8X125M</b>	(b) Adaptador 8x1.25 M - Izquierdo	2,59
<b>G1129-10X100F</b>	(b) Adaptador 10x1.00 F - Izquierdo	2,59
<b>G1129-10X150F</b>	(b) Adaptador 10x1.50 F - Izquierdo	2,59
<b>G1129-1</b>	Fig. nº1 Tapa superior	2,90
<b>G1129-2</b>	Fig. nº2 Ovalillo	1,39
<b>G1129-4</b>	Fig. nº 4 Muelle	1,39
<b>G1129-5</b>	Fig. nº5 Carrete + botón	3,95
<b>G1129-6</b>	Fig. nº 6 Carcasa inferior	3,50

## MUELLES CABEZALES DE HILO

	REFERENCIA	DESCRIPCIÓN	LARGO / ANCHO	P.V.P SIN I.V.A.
(1)	G1104-5	1.- Muelle para Trimmy G1104	53x17 mm	1,39
	G11092-4	2.- Muelle para Trimmy G11092	25x53 mm	1,39
	G1125-4	3.- Muelle para Trimmy G1125	25x30 mm	1,39
(2)	G1127-4	2.- Muelle para Trimmy G1127	25x46 mm	1,39
	G1129-4	2.- Muelle para Trimmy G1129	30x39 mm	1,39
	T25-5	1.- Muelle para Trimmy T25	45x17 mm	1,59
(3)	T35-5	1.- Muelle para Trimmy T35 / T45	50x17 mm	1,59
	SH2320059804	2. Muelle 3GC430/3GC520	40X40mm	1,39
	SH2320034140	3. Muelle CG330/CG430	35X36mm	1,39
	2285800001B	1. Muelle DYM2129A	40X40mm	1,39

## TRIMMYS ADAPTABLES

	REFERENCIA	DESCRIPCIÓN	P.V.P SIN I.V.A.
1	PB454882	(1) Cabezal SF25 Manual 25,4 mm. 4 hilos $\varnothing$ 3,3mm (Aluminio)	33,29
2	PB454978	(2) Cabezal multifilo universal 2-4-6 hilos aluminio Desbrozadoras > 30cc	17,46
3	PB015416	(3) Cepillo acero 190 mm con reductor 25,4 a 20mm Desbrozadoras >40cc	24,75
4	PB006414	(4) Cepillo Nylon 110mm M10x1.25mm	28,95
5	PB6414M	(5) Reductor 25,4/20 mm	2,95

**FILTROS AIRE ADAPTABLES**

		REFERENCIA	DESCRIPCIÓN	MODELO	P.V.P SIN I.V.A.
(1)	(2)	<b>C26-099</b>	(1) Filtro aire	Camon: C26/C26PRO/TCS2600 Zenoah 2500	4,10
(3)	(4)	<b>C26-100</b>	(2) Filtro aire esponja	Camon: C26/C26PRO/TCS2600 Zenoah 2500	0,79
(5)	(6)	<b>C37-ZJA044</b>	(3) Filtro aire	Camon: C37/C41/TCS4100 • Zenoah 2500	3,50
(7)	(13)	<b>C45-ZJB066</b>	(4) Filtro aire	Camon: C45/C50/TCS4600/TCS5000 Zenoah 4500 / 5200	7,50
(12)	(15)	<b>C62-B004</b>	(5) Filtro aire	C62	5,95
(16)	(17)	<b>ZJA056</b>	(6) Filtro aire	GJB-25D	1,75
(7)	(15)	<b>G1548</b>	(7) Filtro aire 574223702	McCulloch: CS35 • Uusqvarna: 120 /125 Partner: 340S / 350S / 36S	0,69
(16)	(17)	<b>SH2320049724</b>	(12) Filtro aire	Camon: EB800-E	5,25
(18)	(20)	<b>TCS4600B-66</b>	(13) Filtro de aire	TCS4600/TCS5000	3,96
(21)	(22)	<b>2036900016A</b>	(15) Filtro aire	DYM DG350 11x6,5x2	1,75
(23)	(24)	<b>2036900015B</b>	(15) Filtro aire	DYM DG450 14x7x2	1,95
(25)	(26)	<b>ALP8781530</b>	(16) Filtro aire	Alpina: P370/P410/MC382/SP410	20,94
(27)	(28)	<b>ALP3781640</b>	(17) Filtro aire	Alpina: Start 45/55/Vareador	12,75
(29)	(30)	<b>Ai332100</b>	(18) Filtro aire	Camon: R41/R47/R54/F41/F54/R29/H27/H28 BlueBird: P410M/P540M/P590M	2,79
(31)	(32)	<b>PB990063</b>	(20) Filtro aire 545061801	Husqvarna 135 / 140 / 435 / 440 / 2240	4,25
(33)	(34)	<b>AI332120</b>	(21) Filtro aire	Bluebird: NEA39/52	3,95
(35)	(36)	<b>G680</b>	(22) Filtro aire 42821410300	Stihl: BR500 / 550 / 600	4,98
(37)	(38)	<b>G675</b>	(23) Filtro aire. Ref. 11231201613	Stihl: 021/023/025/MS210/MS180 MS230 / MS250	4,90
(39)	(40)	<b>G676</b>	(24) Filtro aire. Ref. 00001201654 110x60x65mm	Stihl: 044/046/064/066/MS441 MS460/MS650	19,89
(41)	(42)	<b>G677</b>	(25) Filtro ar. Ref. 11271201621	Stihl: 029/039/MS290/MS310/MS390	8,90
(43)	(44)	<b>G678</b>	(26) Filtro aire. Ref. 11211201617	Stihl: 024/026/MS240/MS260	15,95
(45)	(46)	<b>G679</b>	(27) Filtro aire. Ref. 41341410300	Stihl: FS350/FS400/FS450/FS480	2,98
(47)	(48)	<b>PB414714</b>	(28) Filtro air. Ref. 41471410300	Stihl: FS240 / 260 / 360 / 410 / 460	3,56
(49)	(50)	<b>G691</b>	(29) Filtro aire. Ref. 502198602	Husqvarna: 227R/232R/235R • Jonsered	1,90
(51)	(52)	<b>PB414814</b>	(30) Filtro aire. Ref. 41481410300	Stihl: FS490 / 510 / 560	3,95
(53)	(54)	<b>G693</b>	Filtro aire. Ref. 537186301	Husqvarna: 323R/325R/326R • Jonsered	2,10
(55)	(56)	<b>G694</b>	(32) Filtro air. Ref.537207501	Husqvarna: 570/575/576XP	8,95
(57)	(58)	<b>503413201</b>	(33) Filtro aire EM	Partner: 410/411/510/511 Husqvarna: 40/45 • Jonsered: 1041	7,29
(59)	(60)	<b>G696</b>	(34) Filtro aire. Ref. 530029908	Husqvarna: 36/41/136/137/141/142 • Jonsered	6,90
(61)	(62)	<b>G697</b>	(35) Filtro aire. Ref. 537024002	Husqvarna: 340/345/350/351/353 • Jonsered	8,95
(63)	(64)	<b>G698</b>	(36) Filtro aire. Ref. 575269103	Husqvarna: 362/365/371/372 Jonsered: 2165/2071/2171	11,55
(65)	(66)	<b>A25.2100.9999</b>	(37) Filtro aire	XCS2500TC	6,95
(67)	(68)	<b>A25.1111.9999</b>	(38) Filtro aire	XCS2500C	6,95

**FILTROS DE AIRE ADAPTABLES A MOTORES B&S**

	REFERENCIAS ADAPTABLES	REF. ORIGINAL	L	A	H	PARA MOTORES	P.V.P SIN I.V.A. ADAPTABLE
	PB990062	795066	140	70	57	Briggs & Stratton 7,5 / 8 / 8,5 HP Loncin 6,5 HP	7,95
	PB980001	792038	120	77	58	Briggs Straton EQ700	6,95
	PB4109755	796254	-	-	-	Prefiltro para filtro 795066	1,79
	PB4109521	793676	-	-	-	Prefiltro para filtro 792038	1,59
	PB990303	593260	111	67	32	550E, 575X, 09P7 DYM1560 / DYM1588	4,95
	PB4109773	594201	125	Int. 37	Ext. 76	LT60 RD SRD100	6,98
	PB4100213	271962S	-	-	-	Prefiltro	2,19
	PB455681	394018S	180 Ext.	140 Int.	120 mm	V-Twin OHV Vanguard 16HP Series: 290000, 29400 303400, 303700, 303900, 350400, 350700, 351400, 351700, 422400, 400400	8,95
	PB455688	272490S	180	140	50	Prefiltro para nuestro filtro: PB455681 y PB453301	2,39
	PB457163	692519	198 Ext.	140 Int.	57	Serie: 358700 y 389400 Vanguard Bicilindrico	9,85
	PB455685	691667	184	73	60	8,5 - 10,5 - 11,5 HP vertical Series: 196700, 257700 259700, 28A700, 28B700 28C700, 28D700	8,68
	PB4109781	695302	126	83	103	Briggs	15,59
	PB4100241	497725S	95	57	55	Series:EUROPA OHV	5,75
	PB455687	399968	222	76	64	7 - 8 - 11 HP horizontal	12,90
	PB455684	496894S	184	73	76	12 a 15 HP vertical Series: 282700, 283700, 286700 287700, 28M700, 28N700 28P700, 28Q700, 28R700 28S700, 28V700, 28T700	7,90
	PB455699	272403S	184	73	76	Prefiltro para nuestro filtro: PB455684	2,16
	PB455754	697029	100	64	76	5,5 - 6,5 HP Intek OHV Series:121600	3,95
	PB456572	273356S	100	64	76	Prefiltro para nuestro filtro: PB455754	1,76

**FILTROS DE AIRE Y PREFILTROS ADAPTABLES A MOTORES B&S**

REFERENCIA	REF. ORIGINAL	L	A	H	PARA MOTORES	P.V.P SIN I.V.A. ADAPTABLE
PB453698	491021	171	76	76	12,5 - 14 HP vertical. Vanguard 1 cilindro. Serie: 260700, 261700	11,95
PB4100218	272490S	540	172	60	Prefiltro Kawasaki / Kohker / Toro	1,95
PB455686	497725S	100	65	55	5 HP vertical. Quantum OHV Series: 12U800, 123V09 12U899, 123V02, 12W807	5,61
PB4104334	710265	160	86	25	4HP VANGUARD/MITSUBISHI	7,85
PB453301	394019S	244	89	64	Briggs Straton John Deere	4,98
PB4104322	392286	124	89	60	10/11 y 12HP VERTICAL	6,95
PB455674	270447	124	108	38	5 HP vertical Série 130900	3,49
PB455675	272235S	149	95	32	3 - 3,5 - 3,75HP vertical series 92500 92900 - 95900 - 96500 - 93900 96900 Sprint & Classic	3,95
PB453340	270848	136	105	38	4 HP vertical Series 110900 - 111900	3,95
PB453005	270579S	136	89	38	3 - 3,5 HP vertical series 82500 serie hasta 82997 92599- 92900 - 93500	3,90
PB456790	698369	130	73	32	Modelo Partner 4546SDX Sprint y Quatro Series: 10A900, 10A902, 10B902, 10A982, 98900, 98902, 98982, 9B900, 9C900	2,95
PB455676	491384	178	90	38	7 a 11HP 1 cilindro ind.plus Series:176400, 19B400, 19E400, 19F400, 19G700 192400, 196400	5,90
PB4109896	792101	187	110 150	50	V-TWIN INTEK ENGINES	15,95
PB454811	494511S	178	89	32	3,5 y 5HP I/C y 5,5 HP Vanguard Series: 93400 115400, 133400	7,90
PB455752	499486S	184	109	38	14 -24HP intek V-Twin Series: 405700, 407700 Mod.Partner: 180HCRD	6,95
PB455753	273638S	184	109	-	Prefiltro para nuestro filtro: PB455752	1,95
PB453295	397795S	160	114	19	3,5 - 4 HP Max series: 90700, 91700, 95700, 96700 110700, 112700, 114700 130700, 131700	3,95
PB4100229	399039	150	108	5	Prefiltro para PB453295	3,59
PB453297	399877S	117	117	19	3,5HP Quantum Briggs Straton	3,95



## PREFILTROS Y FILTROS DE AIRE ADAPTABLES A MOTORES B&S



REFERENCIA	REF. ORIGINAL	L	A	H	PARA MOTORES	P.V.P SIN I.V.A. ADAPTABLE
PB453296	491588S	133	114	25	3 - 5HP horizontal 3,5 - 5 HP Quantum GC135, GC160, GCV135, GCV160	2,10
PB455678	491435S	120	102	-	Prefiltro para nuestro filtro: PB453296	2,95
PB17462A	491588S + 491435S	-	-	-	Filtro + Prefiltro	3,15
PB454801	795115	220	79	38	15,5 a 20HP Series: 31E707, 31F777, 31E777, 31G777, 31H777, 280H07, 282H07, 284H07, 284H77	5,95
PB454813	697015	200	72	-	Prefiltro para nuestro filtro: PB454801	1,95
PB454814	794421	184	79	38	10 a 13HP Series: 21A902, 21A907, 21A977, 21B902, 21B906, 21B907, 21B972, 21B976, 21B977	5,95
PB456571	697292	115	64	-	Prefiltro para nuestro filtro: PB454814	1,95
PB990049	794071	117	43	31	Briggs Straton Series 600	4,79
PB990050	797301	114	57	25	Briggs Straton Series 675 / 875	3,95
PB990051	792105	127	118	70	SRD300 / V-Twin16-27hp	9,95
PB990061	17403-ZE1-810	75	28	-	GX160 / GX200	3,95
G431	17231-ZE1-000				GX140 / GX160 / GX200	12,95
PB4109933	17235-Z52-820				GX340 / GX390	32,95

## FILTROS DE AIRE ADAPTABLES A MOTORES HONDA



PB456576	17211-ZF5-V01	133	76	86	GXV340 / 390	11,95
PB453683	17210-ZE3-010 17210-ZE3-505	112	97	92	GX240 / GX270 / GX340 GX390 (8 a 13HP)	7,35
PB453684	17210-ZE2-505 17210-ZE2-515	100	90	77	GX240 / GX270 8HP e 9HP	4,95
PB453686	17210-ZE1-822 17210-ZE1-821 27210-ZE1-505	102	73	68	GX110 / GX120 GX140 / GX160 3,5 - 5 e 5,5HP	5,19
PB453694	17210-ZE8-013 17210-ZE8-003 17210-ZF5-505	130	67	79	8,5,11 e 13HP OHV GXV270/GXV340/GXV390	8,95
PB990052	17218-ZE3-000	-	-	-	Pra filtro PB453683	1,95

**FILTROS DE AIRE ADAPTABLES A MOTORES HONDA**

	REFERENCIA	REF. ORIGINAL	L	A	H	PARA MOTORES	P.V.P SIN I.V.A.
	<b>PB453687</b>	17210-ZE0-822 17210-ZE0-505	105	75	52	GX110 (Mod. antiguo 3,5HP) GX120 (Mod. nuevo 4HP) Loncin	5,75
	<b>PB453691</b>	17210-ZE7-505 17210-ZE7-003	190	65	45	4 y 5HP Serie GXV120 GXV140 y GXV160 Montado en HR216 y HRA216 (distancia entre ejes 75 mm)	7,95
	<b>PB453692</b>	17218-888-003 1728-ZE6-505	190	60	60	Prefiltro para nuestro filtro: PB45391 e PB453248	2,19
	<b>PB453248</b>	17211-888-013 17210-ZE6-003	190	60	50	3,5 a 5HP GXV120 - GV150 GV200 montado en HR194 HR21, HR214, HR215 GX150 / GX200	7,59
	<b>PB453688</b>	17211-ZA0-506	165	105	42	HT3813, HT4213 y GX360K1	10,90
	<b>PB454122</b>	17211-ZE7-W03	177	62	48	GXV160 5,5HP vertical	6,95
	<b>PB455876</b>	17210-734-505 17210-734-003	119 68 Ext.	54 Int.	58	GX160, F560 y F660	7,95
	<b>PB456802</b>	17211-ZE1-000	128	96	40	GX140 / 160 / 200	3,95
	<b>PB454127</b>	17211-ZG9-M00	146	89	25	GXV140 -150 - 160 y HRM 215 Thorx 4500 / Kohler	4,95
	<b>PB75110298</b>	75110298	146	89	25	MTD / Thorx / Kohler GXV140 / 160	7,95
	<b>PB454126</b>	17211-ZG9-800	137	61	25	GXV140 5HP Vertical	5,79
	<b>PB456807</b>	17211-ZL8-000 17211-ZL8-003 17211-ZL8-023	133	114	19	GC135 / GC160 GCV135 / GCV160 GCV190 / Husqvarna	2,95
	<b>PB455678</b>	17218-ZL8-000 491435S	120	102	-	Prefiltro para nuestro filtro: PB456807	1,95
	<b>PB456577</b>	17211-Z0A-013	217	129	22	Honda GCV520 / 530 / 531	8,50
	<b>PB456578</b>	17210-ZJ1-842	244	165	33	Honda GX160RI GX620K / GX670	19,90

## FILTRO ADAPTABLE A MOTORES KAWASAKI



REFERENCIA	REF. ORIGINAL	L	A	H	PARA MOTORES	P.V.P SIN I.V.A.
PB453689	11013-2021 J. Deere AM101191	178	57	62	12,5 HP FB 460 GX95, RX95, SRX95, SX84	8,40
PB453693	531001272 11013-2175 11029-2010 J. Deere M79451	102	64	52	4,5-5 HP vertical FC150 V, VC150V y F615V	5,65
PB455698	11013-2151 11029-6001	205	58	55	6 HP FC-180-V	4,79
PB014175	11029 - 7010	-	-	-	FJ180	4,79
PB014147	11013 - 2132	151	127	60	FE120D - FE170D FD671D - FD721D - FD750D	9,85

## FILTROS DE AIRE ADAPTABLES A MOTORES DOLMAR - MAKITA



PB456501	394 173 010	105	80	58	PC6212 - PC6214 PC6412 - PC7314 DPC6200 - DPC6201 DPC7300 - DPC7301	10,00
PB456502	394 173 030	105	80	10	Prefiltro para nuestro filtro: PB456501	3,97

## FILTROS DE AIRE ADAPTABLES A MOTORES TECUMSEH

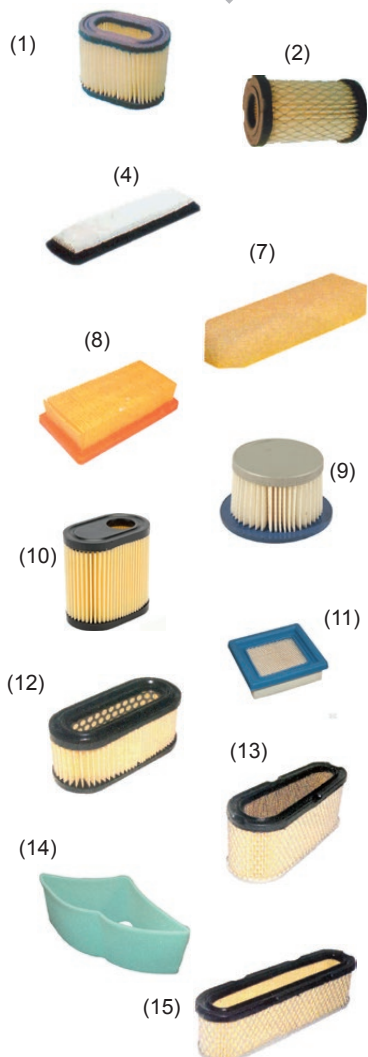

PB455748	(1) 23410060 36745	70	44	56	Centura 5,5 HP LEV115, LEV120, OVRM60 OVRM105 y TVS90	4,95
PB455747	(2) 23410051 35066	44 Ext.	21 Int.	73	ECV100, LEV90, LEV115 Spectra 37/40	2,79
PB455671	(4) 23410030 23410044 35500	183	57	19	TVS90, TVS100 TVS105, TVS120 TVXL105 OVRM40, 50, 60, 65, 105, 3,5HP a 5HP	5,66
PB453697	(7) 23410026	145	40	30	BVS143 / 153	2,95
PB454868	(8) 23410061	135	69	32	Tecnamotor, Geotec, OHV	7,95
PB001346	(9) 30727	92	51	57	2,5-8PK H25-H80	6,95
PB990064	(10) 36905	70	45	72	CVRM65-105/120	4,95
PB001345	(11) 36046	97	85	32	VLV 40-50	6,45
PB454869	(12) 23410028 35850	130	57	59	VLV40 - BVL 198 4HP	6,97
PB454874	(13) 36356	191	57	76	OHV11-17,5Pk	7,59
PB001357	(14) 36357	203	-	73	Prefiltro	5,23
PB454875	(15) 35403	203	51	60	OVXL120, TVM195, TVM220, TVXL200 8 a 13HP	10,69

**FILTROS DE AIRE ADAPTABLES A ROBIN**

REFERENCIA	REF. ORIGINAL	L	A	H	PARA MOTORES	P.V.P SIN I.V.A.
PB011047	267-35003-01	148	82,5	68	EH-36 EH-41	10,75
PB430064	277-32611-07	114	50	48	EX18V EX13/EX17/EX21/MSW1017	8,95
PB430065	279-32607-08	145	84,5	71	EX27	19,79
PB011778	227-32610-07	110	60	65	EY20/EY22/EH17	10,75
PB011779	206-32601-07	89	64	64	EY15 / ey18-30V	17,95
PB454862	207-32600-08	124	95	60	EY25 / EY207	16,75

**FILTRO DE AIRE CORTADORAS PARTNER / HUSQVARNA**

REFERENCIA	REF. ORIGINAL	L	A	H	PARA MOTORES	P.V.P SIN I.V.A.
PB008224	506224272	120	85	55	K650 / K700 / Active	11,95
G1549	510244103	145	115	85	K970 / K1260 / K1270	18,90
PB008225	506226301	205	132	18	K650 / K700 / Active	7,95
PB4104501	506231801	158	108	67	K950 / K1250 / Active	11,95
PB4104503	506268701	253	160	17	K1250 Active	10,95
P506231901	506231901	257	132	17	K950 / K960	9,75

**FILTRO DE AIRE LONCIN**

REFERENCIA	DESCRIPCIÓN	P.V.P SIN I.V.A.
180130187-0001	Prefiltro aire XCT102 Toro / Loncin: LC1P92F-1	2,95
180130188-0001	Filtro de aire XCT102 Toro / Loncin: LC1P92F-1	12,47

## FILTROS DE AIRE ADAPTABLES A MOTORES KOHLER Y KUBOTA



REFERENCIA	REF. ORIGINAL	L	A	H	PARA MOTORES	P.V.P SIN I.V.A.
PB455702	Filtro 1208310 S	114	95	94	CV11, CV16, CV460, CV490 11 a 16HP	14,96
PB456816	2008302 S 531029501	195	196	35	SV470S - SV530S - SV540S SV590S - SV600S - SV610S motores 15 y 17 CV 1 cilindro	10,85
PB456817	3208303 S	144	109	45	SV710 - SV720 - SV730 SV735 - SV740 motores bicilindricos	10,95
PB455706	12681-11220	200	54	51	Kubota 5HP 5 CV / 5019 - 5021	12,95
PB455710	11220-12681	180	-	35	Prefiltro para nuestro filtro: PB455706 Kubota 5HP	3,85

## FILTROS DE ACEITE ADAPTABLE



REFERENCIA	REF. ORIGINAL	Ø	A	H	ABERTURA	PARA MOTORES	P.V.P SIN I.V.A. ADAPTABLE
PB455661	492932S	76	-	57	19,5	Briggs Straton / Tecumseh Kohler / Kawasaki	6,75
PB455666	491056	76	-	86	19,5	Briggs Straton / Honda Husquvarna / John Deere Kohler / Toro	6,95
PB455148	692513	68	-	75	19,5	Briggs Straton / Robin John Deere Kawasaki / Toro Tecumseh	9,45
PB455169	1205001S	75	-	70	3/4"	Ferris / Husquvarna Kohler/ Toto	6,75

**FILTRO DE ACEITE ADAPTABLES**

REFERENCIA	REF. ORIGINAL	Ø	A	H	AGUJERO	PARA MOTORES	P.V.P SIN I.V.A.
<b>PB455662</b>	119660-35150	84	-	72	M20x1,5	Yanmar	9,95
<b>PB455714</b>	15410-MCJ-000	68	-	68	M20x1,5	Honda: GXV520 / 530 / GX360K1	6,95

**SENSORES NIVEL DE ACEITE ADAPTABLES HONDA**

<b>PB456420</b>	15510-ZE1-003					Honda GX120 / GX160 / GX200	15,90
<b>PB456421</b>	15510-ZE2-033					Honda GX240 / 270 / 340 / 390	19,75
<b>PB456327</b>	34150-ZH7-003					Honda Serie GX	6,95

**FILTROS DE ACEITE ADAPTABLES**

<b>PB455662</b>	AM101378 ISEKI	83	-	79	M20x1,5	Toro Yanmar	10,90
<b>PB455663</b>	AM107423 AM101054 ISEKI	93	-	97	19,5	John Deere / Iseki / Kawasaki	6,95
<b>PB455666</b>	AM101207 AM34770 AM39687	76	-	88	19,5	Briggs Straton / Honda Kohler / Toro John Deere	6,95
<b>PB4304710</b>	1521332090	84	-	125	19,05	Kubota:L175 / L185 / L245	15,44
<b>PB4304702</b>	30A4000102	72	-	98	M20x1,5	Mitsubishi	11,99

## CUCHILLAS ADAPTABLES CORTASETOS

	REFERENCIA	DESCRIPCIÓN	P.V.P SIN I.V.A.
(1) 	PB014223	1. Cuchillas Sup. 635 mm. Alpina TS 24 • Dolmar HT 2256 D • Maruyama HT 230 DL Zenoah CHT 2300 • Oleo Mac HT 22 - 26 • Efco TS 322 - TS 326 Robin HT 221 • Robin HF 221 • Kawasaki: KHD600A	39,75
	PB014224	1. Cuchillas Inf. 652 mm. Alpina TS 24 • Dolmar HT 2256 D • Maruyama HT 230 DL Zenoah CHT 2300 • Oleo Mac HT 22 - 26 • Efco TS 322 - TS 326 Robin HT 221 • Robin HF 221 • Kawasaki: KHD600A	39,75
(2) 	PB014225	2. Cuchillas Sup. 784 mm Efco / Oleo-Mac / Maruyama / Marunaca	41,85
	PB014226	2. Cuchillas Inf. 790 mm Efco / Oleo-Mac / Maruyama / Marunaca	41,85
(3) 	PB455123	3. Cuchillas superior 781 mm Robin / Ochiai / Alpina / Dolmar / Maruyama / Stihl	49,75
	PB455124	3. Cuchillas inferior 798 mm Robin / Ochiai / Alpina / Dolmar / Maruyama / Stihl	49,75
(4) 	PB014408	4. Cuchilla superior/ inferior 591 mm Tanaka THT210	41,90
	PB014409	4. Cuchilla superior/ inferior 696 mm Tanaka THT210	41,90
(5) 	PB456120	5. Cuchilla superior 841 mm Kaaz TM310	49,90
	PB456121	5. Cuchilla inferior 841 mm Kaaz TM310	49,90
(6) 	ZJB030	6. Cuchilla superior / Inferior GJB25D • 701 mm	22,75
(7) 	ZJB999	7. Barra corte CPL GJB25D	43,75

## CORTASETOS SIN MOTOR



REFERENCIA	DESCRIPCIÓN	P.V.P SIN I.V.A.
PB012004	Barra corte 650 mm • Tipo Ochiai 3 taladros	160,00
PB5707215	Kit corona CPL • Adap. Stihl 42376420400	72,95
PB122201	Kit corona CPL • Tipo Ochiai	29,75

## CEBADORES ADAPTABLES BRIGGS & STRATTON • TECUMSEH • SUBARU



REFERENCIA	REFERENCIA ORIGINAL	PARA CARBURADORES	P.V.P SIN I.V.A. ADAPTABLE
PB455862	(1). 694394	QUANTUM serie 3,5 - 3,75 B&S 4 CV 10A902, 10A982, 98902, 98982	2,45
PB455863	(2). 694395	QUANTUM serie 5 - 5,5 B&S 6 CV	2,10
PB208751	(3). 632047	Tecumseh	2,29
PB5209690	(4). 594281	Cebador Briggs & Stratton	3,59
PU0001210041	(5). EA190V	Junior / Xplorer / RV / EA	9,15
AI25210020050	(6). -	B42 / DYM1661FB / B46T B51T	4,92
PB430029	(7). Válvula control	Walbro / Kawasaki	1,52

## CEBADORES ADAPTABLES WALBRO - ZAMA



<b>PB456337</b>	1. Walbro: 188-13 / 188-13-1	Modelos HDA y WYK	1,95
<b>PB456338</b>	2. Walbro: 188-512 / 188-570 WT23A / WYJ33 / WYJ34 WYJ45 / WYJ86	Partner / Husqvarna / Stihl Poulain / McCulloch / Homelite Echo / MTD / Ryobi / Tanaka Dolmar / Makita / Zenoah	2,69
<b>PB456339</b>	3. Zama: 0057003, 0057004 Echo: 125381, 08660	ZAMA CIU y CIQ/M	1,95
<b>PB456335</b>	4. Walbro: 188-11 - Echo: 123181, 26030 Shindaiwa: 20036-81670	Walbro: WZ3, WZ22, WZ26, WZ33, WZ35, WZ38, WZ39, WZ43	1,95
<b>PB456336</b>	5. Walbro: 188-12, 188-12-1, 188-14, 188-14-1 - Echo: 123181 - 40630 Homelite: UP-04802 McCulloch: 225834-00 Shindaiwa: 20036, 81670 Stihl: 4133, 121, 2700	Partner: B261/B310/B321 B341/B390 WALBRO modelos: WA, WT, WY, WYJ WYK, WYL, WYP, WZ	1,49
<b>C41-ZJA078A</b>	6. Cebador gasolina	TCS2600 / TCS4100 TCS4600 / TCS5000	1,19
<b>PB456364</b>	7. Cebador 188-513	McCulloch / Husqvarna / Stihl Ryobi / Weed Eater / Partner	3,49
<b>AI188-12</b>	8. Walbro WT/WYK	Original	4,39
<b>ML261874</b>	9. Cebador Maruyama	AE200/AE320/AE420/AE500/BE230	8,63
<b>ML282299</b>	10. Cebador Maruyama	CE420/NE420/NE500/FE352/CER500	12,20
<b>ML626755</b>	11. Cebador Maruyama	Honda: 16032-ZM3-004	4,84
<b>ML649363</b>	12. Cebador Maruyama	KAWASAKI: 49043-2074	17,97

## DEPÓSITO DE GASOLINA ADAPTABLE A MOTORES HONDA, ROBIN, BRIGGS STRATTON



REFERENCIA	DESCRIPCIÓN	REFERENCIA ORIGINAL	PARA MOTORES	P.V.P SIN I.V.A.
<b>PB456410</b>	Depósito gasolina	17510-ZE1-020ZA	GX140 / GX160 / GX200	29,75
<b>PB456412</b>	Depósito gasolina	17510-ZE2-010ZA	GX240 / GX 270	39,95
<b>PB456411</b>	Depósito gasolina	17510-ZE3-010ZA	GX340 / GX390	34,95
<b>PB456415</b>	Filtro reserva de carburante	17672-880-000	GX110, 120, 160, 200 240, 270, 340, 390	4,50
<b>PB990047</b>	Depósito gasolina	Robin	EX17 / EP17 / SP170	59,75
<b>11.009.034.2089</b>	Depósito gasolina	Generadores	2-3kw	26,95
<b>1800100291-001</b>	Depósito gasolina	Generadores	5kw	29,95

## GRIFOS DE GASOLINA ADAPTABLES



REFERENCIA	DESCRIPCIÓN	P.V.P SIN I.V.A. ADAPTABLE	P.V.P SIN I.V.A. ORIGINAL
<b>PB454369</b>	Grifo de gasolina adaptable Honda Ref. Original 16950-ZG9-M02	5,19	-
<b>PB000949</b>	Grifo de gasolina adaptable Briggs Stratton Ref. Original 698183	3,79	8,75
<b>PB698181</b>	Grifo de gasolina adaptable Briggs Stratton Ref. Original 698180	4,90	11,65
<b>PB990089</b>	Grifo de gasolina adaptable Briggs Stratton Ref. Original 698182	4,90	-
<b>PB000950</b>	Grifo + Filtro WM2500 / WM3500 / WM5500 Generadores	6,95	-
<b>PB000198</b>	Grifo + Filtro Tecumseh M10X1.00 Ø 6,35mm	8,30	-
<b>PB5300022</b>	Grifo gasolina M10X1,25	8,75	-
<b>PB5300007</b>	Grifo gasolina Honda M14X1,50 3 Posiciones	9,98	-
<b>PB4204749</b>	Grifo gasolina Briggs 206981/Kholer 2546203S	6,59	-



**INTERRUPTORES Y CONTACTORES ADAPTABLES HUSQVARNA - JONSERED - PARTNER - MCCULLOCH**

	REFERENCIA	DESCRIPCIÓN	REF. ORIGINAL / MOTORES	P.V.P SIN I.V.A.
	PB456324	Interruptor On-Off	Husqvarna: 503098301 Jonsered: 503718201 Partner: 503098302	3,19
	PB456325	Interruptor On-Off	Husqvarna: 503089702 Jonsered: 503717901 Partner: 503717901	3,19
	PB456326	Interruptor On-Off	Husqvarna McCulloch: 538243440, 503718001 Jonsered: 503486502 Partner: 503440502	4,40
	C45-ZJB075	Interruptor On-Off	Camon: C45/C50	2,49
	PB2302183	Interruptor On-Off	Alpina / Efco / Stiga	1,95
	C43.1111.0700	Interruptor ON-OFF automatico	XCS2500C/XCS2500TC/CG430/TC2600 TCS4100/TCS4600/TCS5000/TCS6500	2,19
	PB454301	Interruoptor cuchillas 582107601	Husqvarna · Partner: 532174651, 532154959 Murray: 94927 · Jonsered: 532154959 Snapper: 35658 · Bunton: PL7994 SCAG: 481687	22,75
	PB453740	Interruptor On-Off	Homelite 93653,163938 Standars	3,79
	PB453741	Interruptor pulsador	12 V	13,55
	PB453110	5 terminales 3 posiciones	Partner: 532125104 Husqvarna: 506558701, 506917101 Stiga: 1134-1814 · Toro: 23-0660 Honda: 35100-772-003 · Murray: 21064 MTD 725-0267 · J.Deere: AM102551	8,95
	PB454288	5 terminales 3 posiciones	Partner: 532158913 · Castलगarden: 18450065/1 Simplicity: 1686734,1716061 Noma: 305720, 307305 Snapper: 2-6343 · B&S: 490066 Husqvarna: 532163088, 532158913	10,75
	PB010188	Contacto 7 terminales 4 posiciones	Husqvarna: 532140301 Partner: 532140301 MTD: 725-1717 Murray: 92556	12,79
	TCP19410609/0	Llenado saco	Honda / Murray / Briggs Straton Simplicity / Snapper / Castलगarden SRD100 / SRD200	39,75
	PB6301363	Mando gas +interruptor stop	M6X33mm	18,79

**INTERRUPTORES Y CONTACTORES ADAPTABLES**

REFERENCIA	DESCRIPCIÓN	REF. ORIGINAL / MOTORES	P.V.P SIN I.V.A.
BR000782	Interruptor cortacésped	5,5A 1200W	39,75
BR000774	Interruptor cortacésped	7A 1200W	39,75
BR000775	Interruptor cortacésped	8,5A 1500W	39,75
BR005265	Interruptor cortacésped	10A 1700W	43,75
PB456301	Contactora 7 terminales 4 posiciones	Husqvarna: 532175566, 532163968 Partner: 532163968, 532175566 MTD: 725-1741, 925-1741 Murray: 94762	22,75
PB453749	Interruptor abrazadera con pulsador	12V	8,95
PB455827	Interruptor + Cable	12V	7,98
PB455826	Pulsador parada	12V KAAZ / TANAKA	6,95
PB456323	Interruptor + Cable	12V	16,75
PB011809	Interruptor + Cable	Unversal	18,45
PB013646	Interruptor + Leva seguridad	ø 25mm	76,90
SH2320038803	Interruptor Pare + Cables	Camon: GJD330 / BG431 Echo: CS2600 / 260T / 280T	1,89
PB454357	Interruptor On-Off	36100-ZEI-015: G100/G150/GX110/GX140 36100-ZH8-W41: GX240/GX270/GX340 36100-883-005	2,39
PB453746	(10) Llave contactor Universal	Snapper / Toro / HusquvarnaAriens / Jacobsen	1,25
PB456306	(11) Llave contactor	Husqvarna: 532140401 MTD/ROPER/ Murray	2,75
PB014194	Interruptor asiento	Husqvarna · Partner · Jonsered: 532121305 John Deere: AM104403 MTD: 725-3166, 925-3166	9,75
PB014550	Interruptor: cuchillas/freno embrague	Husqvarna · Partner · Jonsered: 532109553 John Deere: AM128925 MTD: 725-2169A Snapper: 23355, 10108	11,95
PB456282	Interruptor asiento	Husqvarna · Partner · Jonsered: 532160784 John Deere: AM103119 MTD: 725-3167 Toro: 82-2190	9,75
PB454307	Interruptor: saco/freno cuchillas	Husqvarna · Partner · Jonsered: 532176138 MTD: 725-3164A, 925-3164A Snapper: 2-2886, 7022886	12,25
PB454308	Interruptor asiento	Husqvarna · Partner · Jonsered: 532104445 MTD: 725-1657A Toro: 65-741, 38382 Snapper: 14847, 15707, 919098	13,45
CWT0302400	Interruptor pare	WM500	2,79

**FILTROS DE GASOLINA ADAPTABLES**

REFERENCIA	REFERENCIA ORIGINAL	LARGO MM.	Ø EXT MM.	SALIDA MM.	PARA MOTORES	P.V.P SIN I.V.A.
PB453808	Universal	60	17	6	Modelo pequeño	1,90
PB453851	Universal	110	38,1	6,35 y 7,90	Kohler / Toro	1,99
PB456340	B&S: 298090S J. Deere PT4265	45	32	6,35 y 1/4"	Briggs Straton	1,90
PB455892	B&S493629, B&S691035 J. Deere AM1085356 Kawasaki 49010-7001 Kohler 25050-02 Tecumseh 34279B	70	35	6,5 y 8	B&S John Deere Kawasaki Kohler Tecumseh	2,29
PB456341	16955-ZE1-000	52	M10 x 1,25	5,8	GX110, GX120 GX140, GX160 GX240, GX270 GX390	2,90
PB453885	Tillotson OW-802	24	14	5	Homelite / Tillotson	1,79
PB453853	Tillotson OW-497		20	4,5	Motosierras modelo grande	1,95
PB4204747	506264111	58,5	20	4,7	Husquvarna	3,39
PB454023	125-527	30	15	4,5	Walbro: motores hasta 33 cc	2,35
PB454024	125-528	37	20	4,76	Walbro: motores hasta 125 cc	2,95
PB454022	503443201	28	20	5	Partner · Husquvarna Jonsered · Poulan	1,98
G003	0000 350 3502	44,2	21,7	5,3	Stihl / Zama	2,10
G002	Zama ZF1	21,5	13,2	4	Homelite / McCulloch Tecumseh / Zama	1,89
P503443201	Electrolux original	28	20	5	Partner Husquvarna · Jonsered	4,39
PB453854	0000 350 3500	45	20	5,3	Stihl	2,39
SH2320047780	Universal				CG260 / CG330 / CG430	1,19
PB330820	Walbro: 125-529	30	-	3,2	BlueBird · Camon Partner · McCulloch	2,19
G004	Walbro 530095646	39,5	13	3	Poulana · McCulloch	1,96
C26-072	Filtro aceite	34	11	7	Motosierras	0,79

## BOMBA DE GASOLINA ADAPTABLE Y PASATUBOS



REFERENCIA	REFERENCIA ORIGINAL	PARA MOTORES	P.V.P SIN I.V.A. ADAPTABLE
G288	808656 597338	B&S 808656/491922 Honda 16700-ZL8-013 Kawasaki 49040-7001 Kohler 21-393-16-S	16,75
SH2320081830	Pasatubo	CG260 / CG330 / CG430 Castelgarden / Alpina / Stiga BG520A / QJB270 / 3WZ-6F / GGP	1,98
PB1232750320	Pasatubo	Castelgarden / Alpina / Stiga GGP	2,21
PB5209556	Pasatubo	Maruyama Kawasaki 92071-2142 Mitsubishi / Stiga	-0,98
C26-048	Pasatubo + tubos + filtros	C26 / TCS2600	3,98
SH2320081830	Pasatubos	CG260 / CG430 / QJB270 / BG520A	2,49
PB5208167	Pasatubos	SHINDAIWA/ECHO	1,89

## TUBOS DE GASOLINA ADAPTABLES



(1)



(2)



(3)



(4)



(5)

REFERENCIA	DESCRIPCIÓN	EXT.	LONGITUD MTS.	INT.	P.V.P SIN I.V.A.
PB453098	(1) Tubo gasolina vinilo	Ø 8,2 mm	15 m	Ø 5 mm	29,90
PB453147	(1) Tubo gasolina vinilo	Ø 9 mm	15 m	Ø 6 mm	32,90
PB453145	(1) Tubo gasolina vinilo Husquarna - Jonsered	Ø 5 mm	15 m	Ø 2,7 mm	28,75
PB013731	(1) Tubo gasolina vinilo	Ø 8 mm	15 m	Ø 4,8 mm	39,75
PB456330	(1) Tubo gasolina poliuretano	Ø 4,76 mm	15 m	Ø 2,8 mm	59,98
PB453825	(2) Tubo gasolina neopreno	Ø 6 mm	10 m	Ø 3 mm	34,75
PB453826	(2) Tubo gasolina neopreno	Ø 7,2 mm	10 m	Ø 4 mm	33,95
PB5305013	(2) Tubo gasolina reforzado	Ø 11 mm	1 m	Ø 6,35 mm	5,79
PB5304998	(2) Tubo gasolina neopreno	Ø 7 mm	5 m	Ø 3,2 mm	24,95
PB5304999	(2) Tubo gasolina neopreno	Ø 10 mm	5 m	Ø 4,5 mm	35,95
PB5305000	(2) Tubo gasolina neopreno	Ø 5,2 mm	15 m	Ø 3,2 mm	39,95
PB011691	(3) Tubo gasolina silicona	Ø 3 mm	3,8 m	Ø 1,5 mm	20,75
PB011692	(3) Tubo gasolina silicona	Ø 3,5 mm	3,8 m	Ø 2 mm	21,75
PB011690	(3) Tubo gasolina silicona	Ø 5 mm	7,5 m	Ø 2,5 mm	32,75
PB5305004	Tubo gasolina transparente	Ø 6,2 mm	7,6 m	Ø 3,2 mm	6,95
PB5305006	(4) Tubo gasolina transparente	Ø 10,6 mm	3,6 m	Ø 6,35 mm	11,95
PB325376	(4) Tubo gasolina	Ø 5,3 mm	7,6 m	Ø 3,2 mm	19,75
G9210	(5) Tubo gasolina vinilo	Ø 3,5 mm	15 m	Ø 2 mm	33,75
G9211	(5) Tubo gasolina vinilo	Ø 5,0 mm	15 m	Ø 2,5 mm	36,95
G9212	(5) Tubo gasolina vinilo	Ø 6,5 mm	15 m	Ø 3,5 mm	42,75
G9213	(5) Tubo gasolina vinilo	Ø 5 mm	15 m	Ø 3,5 mm	33,75
G9214	(5) Tubo gasolina vinilo	Ø 3,5 mm	3 m	Ø 2,0 mm	12,75

**REGULADORES DE CORRIENTE**

REFERENCIA	DESCRIPCIÓN	P.V.P SIN I.V.A.
PB456327	Electrónico Honda Serie GX Ref. 34150 - ZH7 - 003	6,95
PB454299	Relé 12 V - 5 Bornes Husqvarna / Partner / Arieus / Exmark / Grasshopper / Hustler 532109748 / 539102914	6,95

**SELENOIDES ADAPTABLES**

REFERENCIA	DESCRIPCIÓN	REF. ORIGINAL	MARCA	P.V.P SIN I.V.A.
PB453099	(1) Selenoide 3 bornes	532110832 725-1426/21261 1-8817/112-0309	Husqvarna MTD · Murray Snapper · Toro	12,95
PB455838	(2) Selenoide Universal 4 bornes	Salida batería Ø 7,20 mm alimentación Ø 6,35 mm	Universal	18,29
PB453756	(3) Selenoide Universal 4 bornes	125-2137/212655 1700751/1-8604/28-4210	AYP · Bolebs Gilson · Simplicity Snapper · Toro	15,45
PB453109	(4) Selenoide 3 bornes	24285/53716/305770 725-0530/111674/1-8817	Murray · Noma Ariens · MTD · Toro Snapper	13,75
PB454118	(5) Selenoide 3 bornes	31204-ZAO-003	Honda Modelos: GX120 GX160 GX200	16,90
P532146154	(6) Selenoide EM		Husqvarna · Partner Jonsered · McCulloch	28,97
PB000084	(7) Selenoide M	18736100/0	Castelgarden Honda	13,65
BS806472	(8) Selenoide Fuel	806472	BRIGGS & STRATTON	-
PB2300806	(9) Selenoide	18736111/0	Castelgarden Stiga	14,61
PB2305933	(10) Selenoide	532146154	Husqvarna Toro / Stiga Honda / Briggs	12,75
SY1722739SM	Selenoide	BARON/BARON XL	Snapper Simplicity	-
SY1755381YP	Selenoide	REGENT RD SRD210 / 300	Snapper Simplicity	-

## BUJÍAS CHAMPION



REFERENCIA	MODELO CHAMPION	EQUIVALENCIA NGK	MEDIDA LLAVE	ROSCA	LONGITUD ROSCA	P.V.P SIN I.V.A.
PB455554	Bujía CJ6	BM7A	19 mm	14 mm	9,5 mm	2,46
PB455550	Bujía CJ8	BM6A	19 mm	14 mm	9,5 mm	2,29
PB455552	Bujía CJ7Y	BPM7A	19 mm	14 mm	9,5 mm	2,35
PB455560	Bujía J19LM	B2LM	21 mm	14 mm	9,5 mm	3,30
PB455562	Bujía N9YC	BP6ES	21 mm	14 mm	19 mm	3,30
PB455561	Bujía L82C	B5HS	21 mm	14 mm	12 mm	2,29
PB455551	Bujía L86C	B6HS	21 mm	14 mm	12 mm	3,10
PB855564	Bujía RC12YC	BKRSE	16 mm	14 mm	19 mm	3,98
PB455556	Bujía DJ8J	BM6F	16 mm	14 mm	8,3 mm	3,98

## BUJÍAS CHAMPION CON RESISTENCIA



REFERENCIA	DESCRIPCIÓN	EQUIVALENCIA NGK	P.V.P SIN I.V.A.
RY4C	Bujía RY4C. M10X1.00X6,3	CMR7A / CMR6A	6,98
RZ7C	Bujía RZ7C. M10X1.00X12,5	CMR7H	4,29
RN9YC	Bujía RN9YC. M14X1.25X19	BPR6ES	3,49
RN11YC	Bujía RN11YC. M14X1.25X19	BPR5ES	3,79
RCJ7Y	Bujía RCJ7Y. M14X1.25X9,5	BPMR7A / BPMR6A	3,79
RDJ8J	Bujía RDJ8J. M14X1.25X8,3	BMR6F	3,90
RJ19LM	Bujía RJ19LM. M14X1.25X9,5	BR2LM	4,59
RL86C	Bujía RL86C M14X1.25	BR6HS	3,79

## BUJÍAS CAMON



A933P	Bujía Camon · 21X14X12 mm	L82C / B7HS	1,79
A956P	Bujía Camon · 19X14X9,5 mm	CJ8/BM7A	1,79
A942P	Bujía Camon · 19X14X9,5 mm	CJ7Y/BPM7A	1,79
A967P	Bujía Camon · M10X1.00x12,5	RZ7C / CMR7H	2,59
A936P	Bujía Camon · M14X1.25X19	RN11YC	1,79
A974P	Bujía Camon · 16X14X8,3 mm	RDJ8J	1,79
A938P	Bujía Camon · M10X1.00X6.3	RY4C	2,69

## COMPROBADOR DE CORRIENTE PARA BUJÍAS



REFERENCIA	DESCRIPCIÓN	P.V.P SIN I.V.A.
PB015068	Comprobador de corriente para bujías	15,75

**CAPUCHÓN BUJÍA ADAPTABLES**

	REFERENCIA	DESCRIPCIÓN	REF. ORIGINAL	PARA MOTORES	5,59P.V.P SIN I.V.A.
	<b>PB456953</b>	Capuchón Bujía	501 48 54 02	Husqvarna Jonsered Partner	2,45
	<b>PB453226</b>	Capuchón Bujía NGK LB05F	8051	Universal	2,75
	<b>PB453007</b>	Capuchón Bujía 7 mm		Universal	1,29
	<b>PB453761</b>	Capuchón bujía 5 mm		Universal	2,25
	<b>PB453763</b>	Capuchón bujía Champion		Champion	3,96
	<b>PB453769</b>	Capuchón bujía	066538	Briggs & Stratton Tecumseh	1,79
	<b>PB2205783</b>	Capuchón bujía		Mitsubishi	4,29
	<b>PB306001</b>	Capuchón bujía	30600-ZE1-013	Honda GX - GXV	2,95
	<b>PB999901</b>	Capuchón bujía	Honda	DYM166 / GXV160	3,96
	<b>PB453768</b>	Capuchón bujía		Universal	1,98
	<b>PB453764</b>	Capuchón bujía		Universal	2,96
	<b>PB11064051000</b>	Capuchón+muelle EM	1106.405.1000	Stihl	2,96
	<b>PB013644</b>	Capuchón + Melle	41284051000	Stihl	3,98
	<b>PB2200451</b>	Capuchón bujía 5mm		Universal	1,29

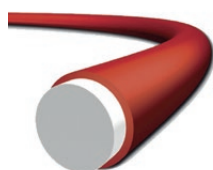
**BOBINAS NYLON REDONDO CAMON**

REFERENCIA	DESCRIPCIÓN	COLOR	P.V.P SIN I.V.A.
PB542700	15 m ø 1,6 mm redondo	Azul	2,30
PB542710	15 m ø 2,0 mm redondo	Verde	2,75
PB541170	120 m ø 2,0 mm redondo	Verde	11,80
PB541150	15 m ø 2,4 mm redondo	Naranja	3,26
PB540810	90 m ø 2,4 mm redondo	Naranja	11,80
PB540870	194 m ø 2,4 mm redondo	Naranja	24,00
PB542770	70 m ø 2,7 mm	Amarillo	12,75
PB543580	15 m ø 3 mm redondo	Rojo	4,60
PB541210	56 m ø 3 mm redondo	Rojo	12,75
PB540890	240 m ø 3 mm redondo	Rojo	41,00
PB8003065	800 m ø 3 mm redondo	Amarillo	112,75
PB543400	15 m ø 3,3 mm redondo	Blanco	6,27
PB541900	40 m ø 3,3 mm redondo	Blanco	12,75
PB541910	100 m ø 3,3 mm redondo	Blanco	21,26
PB541880	204 m ø 3,3 mm redondo	Blanco	41,00
PB7803375	780 m ø 3,3 mm redondo	Amarillo	112,75
PB543030	30 m ø 4,0 mm redondo	Rojo	12,75
PB5764080	576 m ø 4,0 mm redondo	Amarillo	112,75

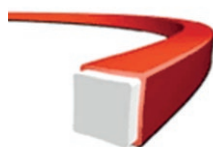
**BOBINAS NYLON CUADRADO CAMON**

PB542360	100 m ø 2,4 mm cuadrado	Rojo	19,64
PB542307	45 m ø 3,0 mm cuadrado	Rojo	12,75
PB542370	100 m ø 3,0 mm cuadrado	Rojo	24,00
PB542310	232 m ø 3,0 mm cuadrado	Rojo	41,41
PB7403065	740 m ø 3,0 mm cuadrado	Amarillo	112,75
PB543029	45 m ø 3,3 mm cuadrado	Rojo	13,75
PB543000	95 m ø 3,3 mm cuadrado	Rojo	24,80
PB542920	190 m ø 3,3 mm cuadrado	Rojo	41,41
PB7103375	710 m ø 3,3 mm cuadrado	Amarillo	112,75
PB5124080	512 m ø 4,0 mm cuadrado	Amarillo	112,75



**BOBINAS NYLON TRENZADO CAMON**

REFERENCIA	DESCRIPCIÓN	COLOR	P.V.P SIN I.V.A.
PB545310	15 m ø 2,0 mm trenzado	Verde	3,69
PB545320	15 m ø 2,4 mm trenzado	Naranja	4,46
PB545330	15 m ø 3,0 mm trenzado	Rojo	5,96
PB545360	84 m ø 2,4 mm trenzado	Naranja	14,38
PB545390	240 m ø 3,0 mm trenzado	Rojo	54,29
PB545370	56 m ø 3,0 mm trenzado	Rojo	14,38
PB545380	38 m ø 3,5 mm trenzado	Rojo	14,38

**BOBINAS NYLON TRENZADO ANTIRUÍDO**

PB850344	44 m ø 3,0 mm trenzado antiruido - Vortex	Negro	15,45
PB753162	162 m ø 3,0 mm trenzado antiruido	Negro	43,00
PB853344	36 m ø 3 mm trenzado antiruido - Vortex	Negro	15,45
PB853900	25 m ø 3,9 mm trenzado antiruido - Vortex	Negro	15,45
PB754200	80 m ø 3,9 mm trenzado antiruido - Vortex	Negro	43,00
PB854300	21 m ø 4,3 mm trenzado antiruido - Vortex	Negro	15,45
PB754500	73 m ø 4,3 mm trenzado antiruido - Vortex	Negro	43,00

**DONUT BOBINA NYLON SIERRA NYLSAW**

AI544740	37 m ø 3 mm	15,60
AI544750	27 m ø 3,5 mm	15,60
AI544760	21 m ø 4 mm	15,60
AI544770	16 m ø 4,5 mm	15,60

**BLISTER NYLON CORTADO**

PB724800	Blister 40 hilos · □ 3x330mm	6,95
PB1512655	KIT 55 hilos □ 420X3,0mm	9,95
PB1512656	KIT 55 hilos □ 420X3,3mm YUCCA	10,95

**DISCO DESBROZADORA CAMON**

	REFERENCIA	DESCRIPCIÓN	Ø EXT. (MM)	Ø INT. (MM)	GROSOR (MM)	P.V.P SIN I.V.A.
1	G975	(1) Disco 2 puntas	255	25,4	2	5,45
	G976	(1) Disco 2 puntas	300	25,4	2	5,50
2	PB410067	(2) Disco 2 puntas Mulching curvo	305	20	4	9,25
	PB410066	(2) Disco 2 puntas Mulching curvo	275	25,4	3	8,50
	PB410068	(2) Disco 2 puntas Mulching curvo	305	25,4	4	9,25
3	PB405869	(3) Disco 2 puntas Mulching	200	25,4	3	7,90
	G977	(3) Disco 2 puntas Mulching	300	20	3	8,75
	G978	(3) Disco 2 puntas Mulching	300	25,4	3	8,75
	G979	(3) Disco 2 puntas Mulching	300	20	4	10,00
4	G980	(3) Disco 2 puntas Mulching	300	25,4	4	10,00
	SH2320007521	(4) Disco 3 puntas	255	25,4	1,4	6,19
5	G981	(5) Disco 3 puntas	255	25,4	1,6	4,95
	G982	(5) Disco 3 puntas	255	20	3	7,95
	G983	(5) Disco 3 puntas	255	25,4	3	7,95
	G984	(5) Disco 3 puntas	300	20	3	8,95
	G985	(5) Disco 3 puntas	300	25,4	3	8,95
5	G994	(5) Disco 3 puntas	300	25,4	4	10,50
	G986	(5) Disco 3 puntas	350	20	4	13,85
	G992	(5) Disco 3 puntas	350	25,4	4	13,85
6	PB405838	(6) Disco 3 puntas Mulching	300	20	4	11,55
	PB405839	(6) Disco 3 puntas Mulching	300	25,4	4	11,55
7	G987	(7) Disco 4 puntas	230	25,4	1,4	6,95
	G988	(7) Disco 4 puntas	255	25,4	1,5	6,95
8	G989	(8) Disco 8 puntas	230	25,4	1,4	9,95
	G990	(8) Disco 8 puntas	255	25,4	1,8	9,95
9	G991	(9) Disco 40 dientes Widia	255	25,4	2	8,95
	G973	(9) Disco 36 dientes Widia	230	25,4	2	8,95
10	AI600060	(10) Disco 80 puntas	255	25,4	1,6	7,95
	PB405807	(10) Disco 80 puntas	220	20	2	7,25

## TORNILLOS Y TUERCAS ADAPTABLES PARA DESBROZADORAS

	REFERENCIA	DESCRIPCIÓN	P.V.P SIN I.V.A.
1	 PB453130	(1) Adaptador M7x1,00 / M10X1.25 Macho	1,49
	G0015	(2) Adaptador 8-10 / 1.25 Macho	1,95
2	 G016	(3) Adaptador M10x1,25 / M10X1.25 Macho	1,90
	G017	(3) Adaptador M10x1,25 / M10X1.25 Macho	1,90
3	 G013	(3) Adaptador M10x1,50 / M12X175 Macho	1,90
	PB455628	(6) Tornillo M6x100 Rosca izquierda L=16mm	1,19
6	 PB002006	(7) Tornillo M7x100 Rosca izquierda L=20 mm	1,29
	PB002007	(7) Tornillo M8 x125 Rosca izquierda L=20 mm	1,29
7	 PB002008	(7) Tornillo M10x1 25 Rosca izquierda L=20 mm	1,29
	PB002009	(7) Tornillo M10x1 50 Rosca izquierda L=20 mm	1,29
8	 ML215610	(8) Tornillo disco 8x20 Maruyama	1,12
	PB002000	(9) Tuerca M8x125 Rosca izquierda	1,29
9	 PB002001	(9) Tuerca M10x100 Rosca izquierda	1,29
	PB002002	(9) Tuerca M10x125 Rosca izquierda	1,39
	PB002003	(9) Tuerca M10x150 Rosca izquierda	1,29
10	 PB002004	(9) Tuerca M12x150 Rosca izquierda	1,29
	PB002005	(10) Tuerca M12x175 Rosca izquierda	1,79
11	 Ai060470	(11) Tuerca disco M10x1.00 SX Bluebird	0,96
	ML232061	(12) Tuerca disco M12x1.25 Maruyama BCV5020	2,29
12	 ML232920	(13) Tuerca disco M10x1.25 Maruyama	2,19
	PB6401036	(13) Tuerca disco M12x1.50	3,49
13	 SH2310003119	(13) Tuerca disco M12x175 lzq.	0,95

**SOPORTE MANILLAR Y ASA DESBROZADORAS CAMON**

REFERENCIA	DESCRIPCIÓN	P.V.P SIN I.V.A.
PB062819	(1) Soporte manillar 28mm / 19mm	8,95
PB062619	(1) Soporte manillar 26mm / 19mm	8,95
PB060004	(2) Soporte manillar 28mm / 22mm	12,95
PB062622	(2) Soporte manillar 26mm / 22mm	10,95
SH2320073567	(3) Cable gas CG330 / CG430	3,95
SH2320046890	(4) Manillar 22mm · CG33 / CG430	15,75
SH2320056562	(5) Asa Izquierda CPL · GJB330/BG431	6,95
SH19001239	(6) Mando gas CPL · 22mm · CG330 / CG430	12,75
SH19000982	(7) Mando gas CPL · 19mm · CG330 / CG430	15,75

**TUBOS Y EJES DE TRANSMISIÓN DESBROZADORAS CAMON**

REFERENCIA	DESCRIPCIÓN	P.V.P SIN I.V.A.
SH19000049	Tubo + eje transmisión 1500x26mm · M8/9T	27,75
SH19000032	Tubo + eje transmisión 1500x26mm · CG330/430	29,90
SH19000050	Tubo + eje transmisión 1500x28mm · Q33 / Q43	27,90
SH19000060	Tubo + eje transmisión 3GC430 / 3GC530	39,90
SH2320082934	Tubo 1500x28m (sin casquillos)	11,85
SH2320013803	Eje 152mm · Ø8mm · 9E/9E/CG330/CG430/Q52	15,75
SH2320049804	Eje Ø10mm · 153,5mm · 11E/11E 3GC430/3GC520	19,75
SH2320041303	Eje Ø8mm · 147,5cm · □5x5mm/M7X100/BG431/BG520A-E	17,96
SH2320100730	Eje Ø8mm · 80cm · 9E □5x5mm/3CS230EF	16,98
SH2320007511	Eje flexible Ø8mm · 79cm · □7x7mm / □7x7mm	15,94
SH2320013385	Eje flexible Ø6,5mm · 151,5cm · □5,1x5,1mm / SG250	13,90
SH2320103409	Eje flexible Ø7mm · 75cm · □5x5mm / 3CS230EF	9,98
SH2320041262	Eje inferior Ø8mm · 7,5cm · 9E □5x5mm / GJD330	14,69

## EJES DE TRANSMISIÓN DESBROZADORAS MARUYAMA



REFERENCIA	DESCRIPCIÓN	P.V.P SIN I.V.A.
SH10200435	Eje superior Ø8mm · 81,5cm · 9E / M8X125 / GJD330	14,63
SH2320041303	Eje Ø8mm · 147,5cm · □9E / M8X125 GJD3305X5mm / M7X100 / BG431/BG520	17,95
ML216965	Eje transmisión 151cm · Ø8mm · □6x6mm / M50BKC / BKC5020	32,91
ML219268	Eje transmisión 153cm · Ø7mm · 7E MX27/M30/M32	21,97
ML230703	Eje transmisión 157,5cm · Ø8mm · □6x6mm · 8XM125 BCV5020 / BCV5021	24,78
ML560515	Eje transmisión 154,5cm · 9E-9E · MX36EH	31,42
ML227923	Eje transmisión 152cm · 7E-7E · MX24E	21,97
ML217897	Eje transmisión 157,5cm · □6x6mm / 8X125 BC420H / BC4321H / BC501H / BC5021H	26,08
ML211895	Eje flexible · 84cm · Ø8mm · □6x6mm M50BKC / BK500 / BKC5020	25,08
SH19000304	Conector accesorios GJD330	14,90

## SOPORTES DE CAMPANA CPL DESBROZADORAS CAMON



REFERENCIA	DESCRIPCIÓN	P.V.P SIN I.V.A.
SH10300889	Soporte campana (solo) CG260/CG260E	13,9
SH19000432	Soporte campana CPL · 26mm · CG330 / CG430	16,75
SH10303113	Soporte campana (solo) Q33/Q43/G330/G430	8,96
SH19000729	Soporte campana CPL · 26mm · BG520A / BG431	19,75

## CAMPANAS PROTECTORAS ADAPTABLES DESBROZADORAS



REFERENCIA	DESCRIPCIÓN	MODELOS	P.V.P SIN I.V.A.
PB0000	Kit reducción para cabezales desbrozadora		1,90
PB453530	Arandela reducción 25,4 mm a 20 mm	Grosor 1,8 mm	0,69
PB454945	1. Campana metálica Ø 85x8 mm		2,35
SH2320106385	1. Campana metálica Ø 70x10 mm	CG415Q33	1,98
SH2320045745	2. Campana metálica Ø 90x12 mm	3GC430 / 3GC520	2,95
PB015177	2. Campana metálica Ø 80x14 mm		3,95
ML215547	8. Campana metálica Ø 60x8 mm	M26SH/M30SH/M32/M32SH BC300/BC320H	3,76
ML902311	8. Campana metálica Ø 75x8 mm	M35SH/M42SH/M50SH/M50BKC BKC5020/BC420H/BC4320H BC5020H/BC500H	3,89
ML232053	8. Campana metálica Ø 80x12 mm	BCV5020	2,76
ML230849	9. Campana metálica Ø 80x10 mm	BC421H / BC5021H	6,53
PB456055	10. Arandela apriete 28mm	PB454986 / PB454987 / PB454988	12,15
PB456054	11. Arandela apriete 26mm	PB454983 / PB454984 / PB454985	14,95
PB456053	12. Arandela centradora 28mm	PB454986 / PB454987 / PB454988	14,35
PB456052	13. Arandela centradora 26mm	PB454983 / PB454984 / PB454985	15,35
SH2320088001	14. Arandela apriete disco	QGJ330/CG260/CG330/CG430/BG431/Q33/Q43	4,25
SH2320088002	15. Arandela centradora disco	QGJ330/CG260/CG330/CG430/BG431/Q33/Q43	4,25
PB1602093	16. Arandelas Kit Stihl	FS160/180/220/280/290/300/310/350 /400/450/480	13,75
PB1602089	17. Arandela centradora	HUSQVARNA: 143R/243R/543RS	16,19
PB1602090	18. Arandela apriete	HUSQVARNA: 143R/243R/543RS	20,49
PB1603000	19. Arandela apriete	STIHL: FR130/220/350/450	10,75
PB1602042B	20. Arandela apriete 10E		3,79
PB1602042A	21. Arandela centradora 10E		7,95
SH2320088003	22. Tuerca disco 10x125 lzq.	GC330/GC260/GC430/Q33/Q43	0,90
SH2310003119	22. Tuerca disco 12x175 lzq.	3GC430/520	0,95

## CODOS ENGRANAJES ADAPTABLES: HUSQVARNA • JONSERED • PARTNER • MCCULLOCH

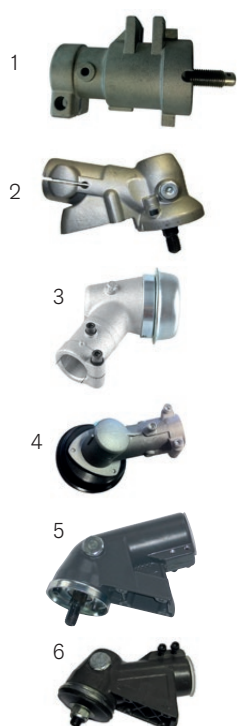

REFERENCIA	DESCRIPCIÓN	P.V.P SIN I.V.A.
538241740	1. Codo engranajes • Ø22mm • □ 5,8x5,8mm Partner: B245/B246 • Mcculloch Cabrio 245 / Cabrio 246	39,90
PB990075	2. Codo engranajes • Ø32mm • 10 Estrías • Ref.: 502297801 Husqvarna: 343R / 345FX / 545FX • Jonsered: 2145BC (sin arandelas)	168,75
PB990074	3. Codo engranajes Ø 28mm / □ 6mm • Ref.: 537295802 Husqvarna: 143R - 243R - 543RS - 543RJ - 543RBX Maruyama: BC420 / BC500	69,95
PB454989	4. Codo engranajes Ø 30mm • 10 Estrías • Eje ø8mm Partner: B400/B420/B422/B470/B472/B522M/BA437BT/BA497BT Mcculloch: 538240824	69,95
PB990048	5. Codo engranajes Husqvarna: 240 R / 245R • Ref.: 502285704 Partner: B380/B405/B450 • Jonsered: GR41 / GR50 / RS44 Tubo 35mm • Eje Ø10mm • 4 estrías	141,00
PB990073	6. Codo engranajes • Ref.: 502271104 Partner: B440 • Husqvarna: 250R / 252RX • Jonsered: RS51 / RS52 Tubo 34mm • Eje Ø10mm • 4 estrías	139,75

## CODOS DESBROZADORAS ADAPTABLES

	REFERENCIA	DESCRIPCIÓN	EJE Ø (MM)	TUBO Ø (MM)	ESTRÍAS	P.V.P SIN I.V.A.
1	PB454982	1. Codo engranajes	8	25	9	47,75
	PB454984	1. Codo engranajes	7,8	26	7	58,95
	PB454985	1. Codo engranajes	8	26	9	49,75
2	PB454986	1. Codo engranajes	8	28	9	49,75
	PB454987	1. Codo engranajes	9	28	10	65,75
3	PB454988	1. Codo engranajes	10	28	11	56,75
	PB454989	2. Codo engranajes	8	30	10	79,75
4	Ai722760	3. Codo engranajes Camon: R29/C34M/R41/R47/R54/F41/F54 Blue Bird: K29/P410/P470/P540/P590		27	Ovalado	149,00
	PB454990	4. Codo engranajes Stihl FS300 / 310 / 350 / 400 Maruyama: BC420 / BC500 / BC4320 / BC5020	8	28	6,1x6,1 mm	69,75
4A	PB454991	4A. Codo engranajes Stihl FS500 / FS550 / FS550L		35	7x7	79,90
	SH1900033	5. Codo engranajes Camon: CG330-E/CG430-E	8	26	9	36,75
5	SH43000931	5. Codo engranajes Camon: CG330-E/CG430-E /Q33/Q43	8	28	9	36,75
	SH19000517	5. Codo engranajes Camon: BG431/BG520A-E	8	26	11	36,75
	SH43000523	5. Codo engranajes 3GC430 / 3GC520	10	28	11	53,95

## CODOS ENGRANAJES MARUYAMA

	REFERENCIA	DESCRIPCIÓN	P.V.P SIN I.V.A.
1	ML231880	(1) Codo engranajes · Maruyama: MX27H/MX33 Ø24mm · 7E · Eje 7mm	115,80
	ML220577	(2) Codo engranajes · Maruyama: M26S/M26SH/M30SH/M32SH Accesorio Rebordeador · Ø24mm · 75 · Eje 7mm	115,34
2	ML232070	(3) Codo engranajes · Maruyama: BC2300RS Ø24mm · 7E · Eje 7mm	100,28
	ML219934	Codo engranajes · Maruyama: MC321 Accesorio Rebordeador Ø24mm · 7E · Eje 7mm	145,41
3	ML228403	(5) Codo engranajes · Maruyama: BC300/BC320H/BC320H-RS Ø24mm · 7E · Eje 7mm	146,16
	ML217088	(6) Codo engranajes · Maruyama: BC420/BC500 Ø28mm · □ 6x6mm · Eje 8mm	160,44
4	ML234835	(7) Codo engranajes · Maruyama: M42SH/M50SH/BC420H/BC4320H BC500H/BC5020H/BC4320H-RS-01 Ø28mm · □ 6x6mm · Eje 8mm	165,45
	ML236695	Codo engranajes · Maruyama: M35SH-H/M50BKC/BKC5020 Ø26mm · □ 6x6mm · Eje 8mm	194,04
5	ML232060	(9) Codo engranajes · Maruyama: BCV5020 Ø28mm · □ 6x6mm · Eje 8mm	177,27
	ML234837	(10) Codo engranajes · Maruyama: BCGX35H Ø26mm · □ 6x6mm · Eje 8mm	165,45
6	ML232070	(11) Codo engranajes · Maruyama: MX24 Ø24mm · 7E · Eje 7mm	100,28
	ML560565	Codo engranajes MX36E / MX36EH Ø26mm · 9E · Eje 8mm	80,99
7	ML231876	Codo engranajes MX27EH Ø24mm · 7E · Eje 7mm	115,80

## ACEITES Y GRASAS



TC201580	(1) Aceite 2T 1 L Camon · Caja 24 uds.	8,56
TC201582	(2) Aceite 2T 0,1 L Camon · Caja 96 uds.	2,65
TC201581	(3) Aceite 4T SAE30 0,6 L Camon · Caja 24 uds.	4,15
TC101175	(5) Aceite cadena 5 L Extra Camon. Caja 4 uds.	17,87
PB014539	(6) Tubo grasa 200 g. Camon. Codos engranajes	4,98
PB721504	(10) Aerosol silicona 400 ml	5,60
PB722004	(10) Arranque rápido 400 ml	7,95
PB720004	(10) Aerosol cadenas 400 ml	5,91
PB454265	(10) Eliminador de resina 400 ml	8,70
PB000573	(10A) Aceite afloja-todo 400 ml	7,20
PB30400	(11) Cartucho de grasa 400 g	5,90
PB10040	(12) Pistola de grasa 400 g	19,75
PB80111400	(11) Cartucho de grasa especial azul	7,98
PB090510	(14) Limpiador de carburadores 500 ml	5,79
PB990098	(8) Limpiador de freno 500 ml	5,39
PB32652	(8) Spray de contactos 500 ml	7,49
PB990022	(20) Aceite 2L 80W90 · Engranajes y ejes	-
PB302005	(21) Aceite 5L Hidráulico Astilladoras	-
PB102005	(22) Aceite 5L Motor 10W40	-
PB104005	(22) Aceite 5L Motor 15W50 HDC	-
PB048810	(25) Detergente limpiador Multiusos 10 L	-

## PINTURA METÁLICA









REFERENCIA	DESCRIPCIÓN	P.V.P SIN I.V.A.
PB200004	Pintura Naranja 400 ml	15,80
PB348004	Pintura Roja 400 ml	15,80
PB610504	Pintura Verde hierba Claas 400 ml	15,80
PB624504	Pintura Verde John Deere 400 ml	15,80
PB700104	Pintura Gris Plata 400 ml	7,60
PB901004	Pintura Blanca 400 ml	7,60
PB919004	Pintura Negra 400 ml	7,30



## BATERÍAS ADAPTABLES

	REFERENCIA	DESCRIPCIÓN	SX	DX	P.V.P SIN I.V.A.
(1) 	<b>ML464020</b>	(1) Batería litio Maruyama (sin cargador) 40V			249,75
(2) 	<b>ML660941</b>	(1) Batería litio Maruyama (sin cargador) 60V · BC60Li / CS60Li			249,75
(3) 	<b>PB991190</b>	(2) Batería 12V 9Ah 135x75x140(sin ácido)	-	+	39,70
(4) 	<b>PB991111</b>	(3) Batería 12V 7Ah 150x65x95	-	+	29,75
(5) 	<b>PB453323</b>	(4) Batería 12V 14 Ah (sin ácido) Largo:134 mm · Ancho: 89 mm · Alto:164 mm	-	+	49,90
(6) 	<b>PB453325</b>	(5) Batería 12V 24 Ah (sin ácido) Largo: 184 mm · Ancho: 124 mm · Alto: 174 mm Marcas: Partner / Husqvarna / Jonsered	-	+	69,95
(7) 	<b>U19MKR</b>	(6) Batería 12V 24 Ah (sin ácido) Largo: 196 mm · Ancho: 130 mm · Alto: 184 mm Marcas: Simplicity / Murray	+	-	69,95
(8) 	<b>PB454275</b>	(7) Batería 12V 18Ah (sin mantenimiento) Largo: 181 mm · Ancho: 77 mm · Alto:167 mm Marcas: Castelgarden	-	+	59,95
(9) 	<b>PB991110</b>	(7) Batería 12V 20Ah (Sin mantenimiento) Largo:181mm Ancho:77mm Alto:167mm	-	+	66,95
(10) 	<b>PB991113</b>	(7) Batería 12V - 22AH (sin mantenimiento) Largo: 181 mm · Ancho: 77 mm · Alto:167 mm	-	+	72,95
(11) 	<b>PB990023</b>	(8) Batería 12V 28Ah (sin mantenimiento) Largo: 196 mm · Ancho: 130 mm · Alto: 181 mm	-	+	71,90
(12) 	<b>PB991175</b>	(9) Batería 12V 30Ah (sin ácido) Largo: 185 mm · Ancho: 130 mm · Alto: 170 mm	-	+	82,95
(13) 	<b>PB991177</b>	(10) Batería 12V 20 Ah MTD / Stiga Largo: 206 mm · Ancho: 90 mm · Alto: 162 mm	-	+	69,90
(14) 	<b>PB120143</b>	(11) Batería 12V 14Ah GEL 134x90x167	-	+	74,95
(15) 	<b>PB991179</b>	(12) Batería 12V 14Ah GEL 151x87x161	-	+	71,75
(16) 	<b>PB001864</b>	(13) Botella ácido 1L			2,90
(17) 	<b>PB454895</b>	(14) Cargador mantenimiento baterías 12V			44,85
(18) 	<b>RA31110</b>	(15) Batería R8500D-T · 150X75X115 mm	+	-	61,75

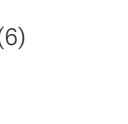
## EMBRAGUES CUCHILLA TRACTORES ADAPTABLES

	REFERENCIA	DESCRIPCIÓN	P.V.P SIN I.V.A.
(1) 	<b>PB2309346</b>	Embrague cuchillas Husqvarna · H: 175 Ø25,4 mm	318,75
(2) 	<b>02.39.10</b>	(2). Camon XCT102 / Alko / Solo / Stihl · H: 90 mm / Int: Ø25,4 mm	229,75
(3) 	<b>SY1736105SM</b>	(2). Simplicity Regent RD / SZT150 / SZT275 / SZT350	-
(4) 	<b>SY84002545</b>	Simplicity SRD210 / SRD310 / SRD360	-
(5) 	<b>G021</b>	(4). Husqvarna / MTD / Snapper / Partner: 532160889 / Warner · H: 76,2 / Int: Ø25,4 mm	189,75
(6) 	<b>G022</b>	(5). Husqvarna / AYP / Ariens / Simplicity / Stiga 532145028	209,75
(7) 	<b>SY5023382</b>	(6). Ferris 4500Z 61"	-

## MOTORES DE ARRANQUE ADAPTABLES

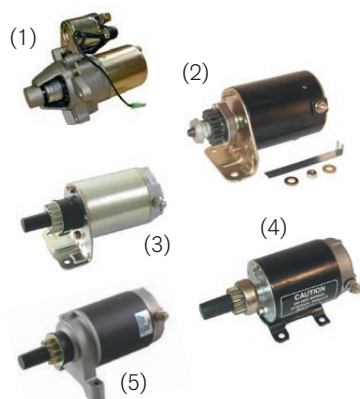

REFERENCIA	DESCRIPCIÓN	P.V.P SIN I.V.A.
G2001	(1) Motor arranque (17 dientes) Honda GX140 / 160 / 200	108,30
G2002	(2). Motor arranque B&S 497595 (16 dientes)	69,75
G2003	(3). Motor arranque B&S 691564 (15 dientes)	109,00
G2004	Motor arranque B&S 693551 / 593934 (14 dientes)	79,75
PB010224	(4). Motor arranque TECUMSEH 36680 / 36463 (16 dientes)	83,95
PB010225	(5). Motor arranque TECUMSEH 37425 / 36914 (10 dientes)	86,90
PB5105899	Motor arranque Kohler 5209819 (13 dientes)	160,75

## REGULADORES DE HONDA



PB990301	Kit regulador GX120 / GX160 / GX200	5,95
PB990302	Kit regulador GXV140 / GXV160	6,95
PB990304	Kit regulador GX240 / GX270	6,95
PB990305	Kit regulador GX340 / GX390	6,95
PB5204973	Kit regulador Tecumseh 16170001	6,95

## MOTORES DE 4 TIEMPOS ADAPTABLES CAMON - PUBERT



REFERENCIA	DESCRIPCIÓN	P.V.P SIN I.V.A.
CWE1100000	1. Motor GX196 cc Motoazadas WM500 / WM1000 - Ø 19 mm. L: 58mm	190,00
PU0330011045	2. Motor Honda GX160 - Motoazadas Pubert Eje Ø 19 mm L: 58 mm	615,00
PU0330091010	3. Motor RV225 Junior Eje Ø 22 mm. L: 70mm	375,00
PU0330091005	3. Motor RV170. Eje: 22x70 First	325,00
PU0330091003	4. Motor Rato R210 721RA Eje Ø19,5 mm. L: 60 mm	299,00
PU0330011050	5. Motor GCV200 Xtrem Eje Ø22 mm. L: 83 mm	659,00
PU0330011028	6. Motor GXV390 L.Senior	1.251,75
D40.0103.0602	7. Motor Loncin 16HP XCT102 Eje Ø25 mm. L: 78mm	690,75
PU0330121001	8. Motor Yamaha MA190 XPLOERER	398,75
T2032250	9. Motor 3HP B42/B46T · Eje Ø 25 mm. L: 49mm	240,75
T2032260	9. Motor 4HP B51T	295,75
Y6100000000	Motor G42P	208,95
YB2DY0B0000	Motor G46DHL	218,95
YC2DY0B0000	Motor G51SHL	229,75
GCV170N3000	Motor GCV170	358,75

## MOTORES ELÉCTRICOS CAMON

(1)



REFERENCIA

YLQ130-997

DESCRIPCIÓN

(1) Motor Hidrolimpiadora YLQ130

P.V.P  
SIN I.V.A.

39,75

(2)



YLQ170-995

(2) Motor Hidrolimpiadora YLQ170

99,75

(3)



2051900015B

(3) Motor DYM 2129A · 800W

16,95

2050100152B

(3) Motor DYM 5169 · 2500W

27,90

## ESCOBILLAS ADAPTABLES

REFERENCIA

DESCRIPCIÓN

P.V.P  
SIN I.V.A.



ES0100

Par escobillas 6,4X6,4X16mm

7,95



ES0408

Par escobillas 5X5X10,5mm

10,95



ES079901

Par escobillas 5X6X11mm

15,95



ES0839

Par escobillas 3,8X5,8X12mm

12,95



ES0148

Par escobillas 5X8X15mm

7,95



ES0185

Par escobillas 5X8X15,5mm

4,98

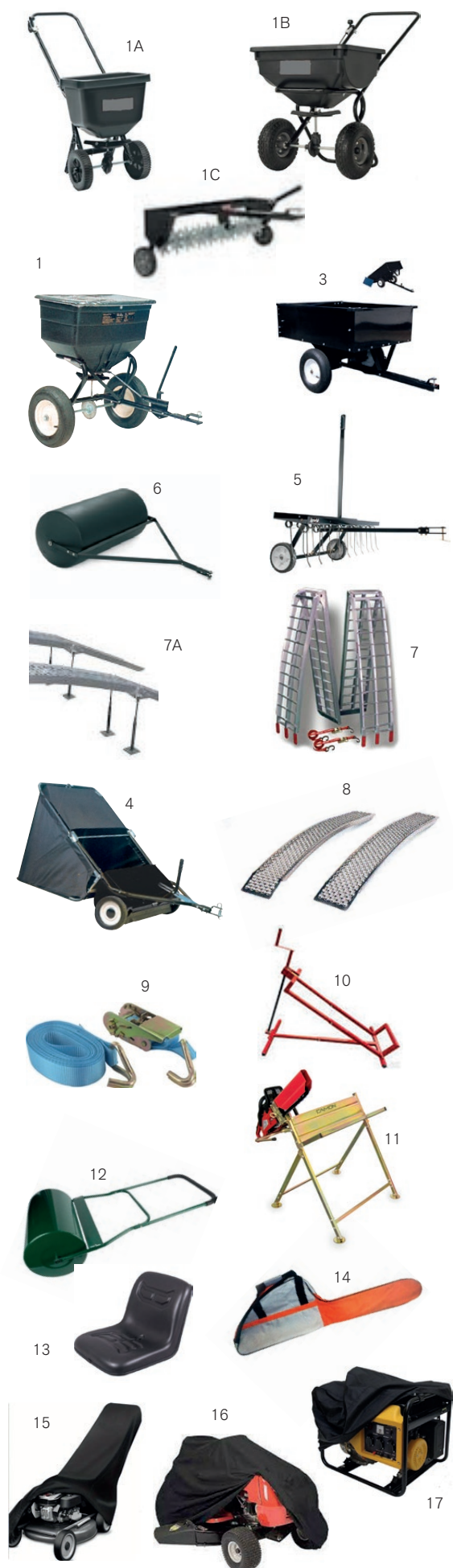
**ACCESORIOS TRACTORES CORTACÉSPEDES Y MOTOSIERRAS**

REFERENCIA	DESCRIPCIÓN	P.V.P SIN I.V.A.
PB450409	1A.- Abonadora manual 20L	139,90
PB450388	1B.- Abonadora manual 37L	299,75
PB450544	1C.- Aireador césped 80cm	289,00
PB455210	1.- Abonadora 55 kg Roda 600X6	248,90
PB455200	3.- Remolque basculante 102x82x29 cm 225 KG / Rueda 400x8	327,75
PB455236	4.- Barredora recogedor 96 cm Capacidad bolsa: 340 L	332,75
PB450294	5.- Escarificador hierba 100 cm	143,00
PB450268	6.- Rulo pisar en poliester 100x45 cm	569,00
G9201	7.- Rampa plegable alum. 226x30cm (par) Máx: 500 kg	249,00
G9202	7A.- Kit 4 soportes rampas G9201 (opcional) Máx: 1.000 kg	21,95
G9217	8.- Rampa recta 1,5 metros EM (par). 450 kilos	216,75
G9218	8.- Rampa curva 1,5 metros EM (par). 450 kilos	207,85
G9221	8.- Rampa curva 2 metros EM (par). 450 kilos	271,75
G9208	8.- Rampa recta 2,5 m - 1.000 kg (par)	564,95
G9209	8.- Rampa curva 2,5 m - 1.000 kg (par)	695,75
PB9108065	9.-Correa amarre con trinquetes 5 m / 500 kg	19,75
PB454530	10.- Elevador tractor lateral. 400 kg	88,75
G9200	11.- Caballete troncos motosierra Máximo: 100 kg	98,75
PB070707	12.- Rulo manual 500 mm x 320 mm - 45 L	129,00
G5004	13.- Asiento tractor	82,95
BT-M	14.- Bolsa transporte motosierras Camon C41/C45/C50/TCS4100/TCS4600/TCS5000	7,95
BT-G	14.- Bolsa transporte motosierras Camon C62 / TCS6200	9,95
PB453132	15.- Lona protectora cortacéspedes 185x59x68 cm	19,85
PB454131	16.- Lona protectora tractores cortacéspedes 275x130x140 cm	35,75
PB9102496	17.- Lona protectora generadores 73x53x61 cm	22,75

## ACCESORIOS JARDÍN



REFERENCIA	DESCRIPCIÓN	LONGITUD	ANCHURA	P.V.P SIN I.V.A.
PB300200	Toldo lona verde	3 metros	2 metros	8,95
PB400300	Toldo lona verde	4 metros	3 metros	16,75
PB500300	Toldo lona verde	5 metros	3 metros	19,75
PB600300	Toldo lona verde	6 metros	3 metros	24,75
PB600400	Toldo lona verde	6 metros	4 metros	29,95
PB800400	Toldo lona verde	8 metros	4 metros	39,95
PB600500	Toldo lona verde	6 metros	5 metros	37,95
PB800600	Toldo lona verde	8 metros	6 metros	57,75
PB1000600	Toldo lona verde	10 metros	6 metros	59,90
PB100800	Toldo lona verde	10 metros	8 metros	89,90
PB1200800	Toldo lona verde	12 metros	8 metros	113,90
PB51901225	Manguera 1/2" - riego	25m	Ø13mm	21,90
PB51901925	Manguera 3/4" - riego	25m	Ø19mm	37,95
PB519131	Juego boquilla y conectores	-	1/2" y 3/4"	21,98
PB990097	Pasta para lavar manos 10 L	-	-	26,95
PB11102	Bobina papel	21 cm x 125m	Blanco	8,98
PB454917	Bobina papel	23cm x 370m	Azul	26,95
PB23102	Bobina papel reciclado	26 cm	Marrón	15,95
380VP41	Par botas de goma Talla 41	PVC	Verde	28,90
380VP42	Par botas de goma Talla 42	PVC	Verde	28,90
380VP43	Par botas de goma Talla 43	PVC	Verde	28,90

**ROPA TALLER**

REFERENCIA	DESCRIPCIÓN	P.V.P SIN I.V.A.
A0007-50	Buzo taller - Talla 50	49,75
A0007-52	Buzo taller - Talla 52	49,75
A0007-54	Buzo taller - Talla 54	49,75
A0007-56	Buzo taller - Talla 56	49,75
A0007-58	Buzo taller - Talla 58	49,75
A0007-60	Buzo taller - Talla 60	49,75
A0007-62	Buzo taller - Talla 62	49,75
A0007-64	Buzo taller - Talla 64	49,75
A0007-66	Buzo taller - Talla 66	49,75
A0049-50	Peto taller - Talla 50	45,95
A0049-52	Peto taller - Talla 52	45,95
A0049-54	Peto taller - Talla 54	45,95
A0049-56	Peto taller - Talla 56	45,95
A0049-58	Peto taller - Talla 58	45,95
A0049-60	Peto taller - Talla 60	45,95
A0049-62	Peto taller - Talla 62	45,95
A0049-64	Peto taller - Talla 64	45,95
A005-52	Bata taller - Talla 52	43,95
A005-54	Bata taller - Talla 54	43,95
A005-56	Bata taller - Talla 56	43,95
A005-58	Bata taller - Talla 58	43,95
A005-60	Bata taller - Talla 60	43,95
A005-62	Bata taller - Talla 62	43,95

**ARTÍCULOS PUBLICITARIOS**

REFERENCIA	DESCRIPCIÓN	P.V.P SIN I.V.A.	
 <b>CABOLI</b>	Boligrafo Camon	1,26	
 <b>CAGORRA</b>	Gorra Camon	5,45	
 <b>CAMISETACA-L</b>	Camiseta Camon Talla L	7,85	
	<b>CAMISETACA-M</b>	Camiseta Camon Talla M	7,85
	<b>CAMISETACA-XL</b>	Camiseta Camon Talla XL	7,85
	<b>CAMISETACA-XXL</b>	Camiseta Camon Talla XXL	7,85
 <b>MLBOLI</b>	Boligrafo Maruyama	1,26	
 <b>MLGORRA</b>	Gorra Maruyama	4,96	
 <b>ML-CAMISETA-L</b>	Camiseta Camon Talla L	7,85	
	<b>ML-CAMISETA-M</b>	Camiseta Camon Talla M	7,85
	<b>ML-CAMISETA-XL</b>	Camiseta Camon Talla XL	7,85
	<b>ML-CAMISETA-XXL</b>	Camiseta Camon Talla XXL	7,85
 <b>PM-M</b>	Polar Maruyama bordado talla M	26,95	
	<b>PM-L</b>	Polar Maryama bordado talla L	26,95
	<b>PM-XL</b>	Polar Maruyama bordado talla XL	26,95
	<b>PM-XXL</b>	Polar Maruyama bordado talla XXL	26,95
 <b>PP-M</b>	Polar Camon bordado talla M	26,95	
	<b>PP-L</b>	Polar Camon bordado talla L	26,95
	<b>PP-XL</b>	Polar Camon bordado talla XL	26,95
	<b>PP-XXL</b>	Polar Camon bordado talla XXL	26,95



NOTAS

A series of horizontal dotted lines for taking notes, starting from the top of the page and extending to the bottom.





NOTAS

A series of horizontal dotted lines for writing notes, starting from the top of the page and extending to the bottom.



NOTAS

A series of horizontal dotted lines for taking notes, starting from the top of the page and extending to the bottom.





**GALAICA IMPORTADORA DE MAQUINARIA, S.A.**

Estrada Coruña, 355 · 27298 LUGO - ESPAÑA

Tel.: 982 26 42 19 · [gaima@gaima.net](mailto:gaima@gaima.net) · [www.gaima.net](http://www.gaima.net)

Fax Pedidos y Serv. Téc.: 982 26 44 83

Fax Administración: 982 26 44 82